

The
Pragmatic
Programmers

Programming Ruby

The Pragmatic Programmers' Guide



Dave Thomas,
with Chad Fowler and Andy Hunt

Second Edition.
Includes Ruby
1.8

Developers the world over talk about *Programming Ruby* and the Ruby language...

“Ruby is a wonderfully powerful and useful language, and whenever I’m working with it, this book is at my side.”

► **Martin Fowler**, Chief Scientist, ThoughtWorks

“If your world revolves around Java, as mine did, then you need this outstanding book to learn all the wonderful things you’re missing. There’s just one catch: you’ll be spoiled from then on. Indeed, after reading just a few pages of *Programming Ruby*, programming in any language other than Ruby will feel like you’re pushing rope.”

► **Mike Clark**, Author and Consultant

“Ruby is smart, elegant, and fun, and it deserves a book that’s smart, elegant, and fun. The first edition of *Programming Ruby* was such a book; the second edition is even better.”

► **James Britt**, Administrator, <http://ruby-doc.org>

“The best reason to learn a new programming language is to learn to think differently. The best way to learn to think the Ruby way is to read *Programming Ruby*. Several years ago, with the first edition of this book, I did just that. Since then, I’ve had a constant stream of *enjoyable* Ruby programming experiences. This is due in no insignificant part to the quality of the source from which I learned the language. I’m not the only person I’ve heard say that every language should have a book like this.”

► **Chad Fowler**, Codirector, Ruby Central, Inc.

“The PickAxe got me started on Ruby. It is still the first book I turn to.”

► **Ryan Davis**, Founder, Seattle.rb

“This book changed my life. Sounds rather clichéd, but it’s the truth. After six years and 300,000 lines of Java code, I needed a change. That change occurred upon reading the first edition of this book. With the support of a solid community and ever-growing foundation of superb libraries, I founded a company that largely profits from applying Ruby to solve real-world problems. Ruby is ready for prime time, and this new version of the PickAxe will show a waiting world what a gem Ruby really is.”

► **Rich Kilmer**, President and CEO, InfoEther LLC

“The first edition of PickAxe has been a desk-side companion for years. The second edition will be an eagerly awaited replacement.”

► **Tom Enebo**, JRuby Developer

“The first edition of *Programming Ruby* brought about no less than the introduction of Ruby on a large scale outside of Japan, in the process becoming the *de facto* standard published language reference and an oft-cited model of clear, effective technical writing. The appearance of the second, expanded edition is exciting for Ruby programmers around the world and will no doubt attract a fresh wave of newcomers to this elegant, versatile language.”

► **David A. Black, Ph.D.**, Codirector, Ruby Central, Inc.

“Ruby is my definite choice for all scripting and prototyping issues, and this book will help you to discover its usefulness as well as its beauty. Apart from that, it’s really fun to read!”

► **Robert Klemme**

“I bought the first edition of this book the day it was released and had a fantastic time using it to learn Ruby. I eventually bought a second copy to keep at home. But Ruby has changed since then. I’m delighted that this second edition of *Programming Ruby* is available to help a new round of programmers learn about this fantastic, beautiful language. And it’s not just good news for Ruby newbies, of course—like me, most Ruby developers will want a copy (no, make that two) so that all of the details about today’s Ruby will be close at hand.”

► **Glenn Vanderburg**, Software Architect, Countrywide Financial

“Ruby is one of those great languages that takes an afternoon to start using and years (maybe a lifetime) to master. In C, I’m always having to work around the limitations of the language; in Ruby, I’m always discovering a neater, cleaner, more efficient way to do things. *Programming Ruby* is the essential reference to the Ruby language. More than just teaching you the syntax, it teaches you the spirit and the feel of the language.”

► **Ben Giddings**

“Confucius said, “What you hear, you forget.” He also said, “What you do you understand.” But it’s not easy to actually “do” things unless you’re using a great language with strength in quick and clean prototyping. In my case, this language is Ruby! Thank you!”

► **Michael Neumann**

Programming Ruby

The Pragmatic Programmers' Guide

Second Edition

Dave Thomas

with Chad Fowler
and Andy Hunt

Many of the designations used by manufacturers and sellers to distinguish their products are claimed as trademarks. Where those designations appear in this book, and The Pragmatic Programmers, LLC, was aware of a trademark claim, the designations have been printed in initial capital letters or in all capitals.

Every precaution was taken in the preparation of this book. However, the publisher assumes no responsibility for errors or omissions or for damages that may result from the use of information (including program listings) contained herein.

This book is a heavily revised version of the book *Programming Ruby*, originally published by Addison Wesley. This book is printed with their permission.

Our Pragmatic courses, workshops, and other products can help you and your team create better software and have more fun. For more information, as well as the latest Pragmatic titles, please visit us at

<http://www.pragmaticprogrammer.com>

Copyright © 2005 The Pragmatic Programmers, LLC. All rights reserved. No part of this publication may be reproduced, stored in a retrieval system, or transmitted, in any form, or by any means, electronic, mechanical, photocopying, recording, or otherwise, without the prior consent of the publisher.

Printed in the United States of America.

ISBN 0-9745140-5-5

Text printed on acid-free paper.

Second Printing, November 2004

Version: 2004-10-26

Contents

FOREWORD TO THE FIRST EDITION	xvii
FOREWORD TO THE SECOND EDITION	xix
PREFACE	xx
ROAD MAP	xxvi

PART I—FACETS OF RUBY

1 GETTING STARTED	2
Installing Ruby	2
Running Ruby	4
Ruby Documentation: RDoc and ri	7
2 RUBY.NEW	9
Ruby Is an Object-Oriented Language	9
Some Basic Ruby	11
Arrays and Hashes	14
Control Structures	16
Regular Expressions	17
Blocks and Iterators	19
Reading and 'Riting	21
Onward and Upward	22
3 CLASSES, OBJECTS, AND VARIABLES	23
Inheritance and Messages	25
Objects and Attributes	27
Class Variables and Class Methods	31
Access Control	35
Variables	37

4	CONTAINERS, BLOCKS, AND ITERATORS	40
	Containers	40
	Blocks and Iterators	46
	Containers Everywhere	54
5	STANDARD TYPES	55
	Numbers	55
	Strings	57
	Ranges	62
	Regular Expressions	64
6	MORE ABOUT METHODS	74
	Defining a Method	74
	Calling a Method	76
7	EXPRESSIONS	81
	Operator Expressions	82
	Miscellaneous Expressions	83
	Assignment	84
	Conditional Execution	87
	Case Expressions	92
	Loops	94
	Variable Scope, Loops, and Blocks	99
8	EXCEPTIONS, CATCH, AND THROW	101
	The Exception Class	101
	Handling Exceptions	102
	Raising Exceptions	106
	Catch and Throw	108
9	MODULES	110
	Namespaces	110
	Mixins	111
	Iterators and the Enumerable Module	113
	Composing Modules	113
	Including Other Files	116
10	BASIC INPUT AND OUTPUT	119
	What Is an IO Object?	119
	Opening and Closing Files	120
	Reading and Writing Files	121
	Talking to Networks	125

11	THREADS AND PROCESSES	127
	Multithreading	127
	Controlling the Thread Scheduler	132
	Mutual Exclusion	133
	Running Multiple Processes	139
12	UNIT TESTING	143
	Test::Unit Framework	144
	Structuring Tests	148
	Organizing and Running Tests	151
13	WHEN TROUBLE STRIKES	155
	Ruby Debugger	155
	Interactive Ruby	156
	Editor Support	157
	But It Doesn't Work!	159
	But It's Too Slow!	162

PART II—RUBY IN ITS SETTING

14	RUBY AND ITS WORLD	167
	Command-Line Arguments	167
	Program Termination	170
	Environment Variables	171
	Where Ruby Finds Its Modules	172
	Build Environment	173
15	INTERACTIVE RUBY SHELL	174
	Command Line	174
	Configuration	179
	Commands	183
	Restrictions	185
	rtags and xmp	185
16	DOCUMENTING RUBY	187
	Adding RDoc to Ruby Code	187
	Adding RDoc to C Extensions	195
	Running RDoc	199
	Displaying Program Usage	200

17	PACKAGE MANAGEMENT WITH RUBYGEMS	203
	Installing RubyGems	204
	Installing Application Gems	204
	Installing and Using Gem Libraries	206
	Creating Your Own Gems	211
18	RUBY AND THE WEB	222
	Writing CGI Scripts	222
	Cookies	231
	Improving Performance	234
	Choice of Web Servers	234
	SOAP and Web Services	236
	More Information	240
19	RUBY Tk	241
	Simple Tk Application	241
	Widgets	242
	Binding Events	246
	Canvas	247
	Scrolling	249
	Translating from Perl/Tk Documentation	251
20	RUBY AND MICROSOFT WINDOWS	253
	Getting Ruby for Windows	253
	Running Ruby Under Windows	254
	Win32API	254
	Windows Automation	255
21	EXTENDING RUBY	261
	Your First Extension	261
	Ruby Objects in C	264
	The Jukebox Extension	270
	Memory Allocation	279
	Ruby Type System	280
	Creating an Extension	282
	Embedding a Ruby Interpreter	287
	Bridging Ruby to Other Languages	290
	Ruby C Language API	291

PART III—RUBY CRYSTALLIZED

22 THE RUBY LANGUAGE	302
Source Layout	302
The Basic Types	304
Names	313
Variables and Constants	315
Expressions	323
Method Definition	330
Invoking a Method	333
Aliasing	336
Class Definition	337
Module Definitions	339
Access Control	341
Blocks, Closures, and Proc Objects	341
Exceptions	345
Catch and Throw	347
23 DUCK TYPING	349
Classes Aren't Types	350
Coding like a Duck	354
Standard Protocols and Coercions	355
Walk the Walk, Talk the Talk	361
24 CLASSES AND OBJECTS	362
How Classes and Objects Interact	362
Class and Module Definitions	370
Top-Level Execution Environment	376
Inheritance and Visibility	376
Freezing Objects	377
25 LOCKING RUBY IN THE SAFE	379
Safe Levels	380
Tainted Objects	381
26 REFLECTION, OBJECTSPACE, AND DISTRIBUTED RUBY	384
Looking at Objects	385
Looking at Classes	386
Calling Methods Dynamically	388
System Hooks	391
Tracing Your Program's Execution	393
Marshaling and Distributed Ruby	395
Compile Time? Runtime? Anytime!	400

PART IV—RUBY LIBRARY REFERENCE

27 BUILT-IN CLASSES AND MODULES	402
Alphabetical Listing	403
Array	406
Bignum	420
Binding	423
Class	424
Comparable	426
Continuation	427
Dir	428
Enumerable	433
Errno	439
Exception	440
FalseClass	443
File	444
File::Stat	456
FileTest	462
Fixnum	463
Float	466
GC	470
Hash	471
Integer	480
IO	482
Kernel	495
Marshal	514
MatchData	516
Math	519
Method	522
Module	524
NilClass	540
Numeric	541
Object	546
ObjectSpace	557
Proc	559
Process	562
Process::GID	568
Process::Status	570
Process::Sys	573
Process::UID	575
Range	576
Regexp	579

Signal	583
String	585
Struct	605
Struct::Tms	609
Symbol	610
Thread	612
ThreadGroup	619
Time	621
TrueClass	629
UnboundMethod	630
28 STANDARD LIBRARY	632
Abbrev	634
Base64	635
Benchmark	636
BigDecimal	637
CGI	638
CGI::Session	640
Complex	641
CSV	642
Curses	643
Date/DateTime	644
DBM	645
Delegator	646
Digest	647
DL	648
dRuby	649
English	650
Enumerator	651
erb	652
Etc	654
expect	655
Fcntl	656
FileUtils	657
Find	658
Forwardable	659
ftools	660
GDBM	661
Generator	662
GetoptLong	663
GServer	664
Iconv	665
IO/Wait	666

IPAddr	667
jcode	668
Logger	669
Mail	670
mathn	671
Matrix	673
Monitor	674
Mutex	675
Mutex_m	676
Net::FTP	677
Net::HTTP	678
Net::IMAP	680
Net::POP	681
Net::SMTP	682
Net::Telnet	683
NKF	684
Observable	685
open-uri	686
Open3	687
OpenSSL	688
OpenStruct	689
OptionParser	690
ParseDate	692
Pathname	693
PP	694
PrettyPrint	695
Profile	696
Profiler__	697
PStore	698
PTY	699
Rational	700
readbytes	701
Readline	702
Resolv	703
REXML	704
Rinda	706
RSS	707
Scanf	708
SDBM	709
Set	710
Shellwords	711
Singleton	712
SOAP	713

Socket	714
StringIO	715
StringScanner	716
Sync	717
Syslog	719
Tempfile	720
Test::Unit	721
thread	722
ThreadsWait	723
Time	724
Timeout	725
Tk	726
tmpdir	727
Tracer	728
TSort	729
un	730
URI	731
WeakRef	732
WEBrick	733
Win32API	734
WIN32OLE	735
XMLRPC	736
YAML	737
Zlib	738

PART V—APPENDIXES

A SOCKET LIBRARY	740
BasicSocket	741
Socket	743
IPSocket	747
TCPSocket	748
SOCKSSocket	749
TCPServer	750
UDPsocket	751
UNIXSocket	753
UNIXServer	754

B	MKMF REFERENCE	755
	mkmf	755
C	SUPPORT	758
	Web Sites	758
	Download Sites	759
	Usenet Newsgroup	759
	Mailing Lists	759
D	BIBLIOGRAPHY	761

List of Tables

2.1	Example variable and class names	15
5.1	Character class abbreviations	68
7.1	Common comparison operators	89
11.1	Two threads in a race condition	135
13.1	Debugger commands	165
14.1	Environment variables used by Ruby	172
15.1	irb command-line options	175
17.1	Version operators	206
18.1	Command-line options for erb	230
21.1	C/Ruby data type conversion functions and macros	266
22.1	General delimited input	304
22.2	Substitutions in double-quoted strings	306
22.3	Reserved words	314
22.4	Ruby operators (high to low precedence)	324
25.1	Definition of the safe levels	383
27.1	Class Array: pack directives	414
27.2	Class File: match-mode constants	447
27.3	Class File: path separators	449
27.4	Class File: open-mode constants	451
27.5	Class File: lock-mode constants	455
27.6	Class IO: mode strings	483
27.7	Module Kernel: sprintf flag characters	510
27.8	Module Kernel: sprintf field types	511
27.9	Module Kernel: file tests with a single argument	512
27.10	Module Kernel: file tests with two arguments	512
27.11	Class Numeric: methods and subclasses	543
27.12	Class Numeric: divmod, modulo, and remainder	544
27.13	Class String: backslash sequences in substitution strings	593
27.14	Class String: unpack directives	603
27.15	Class Time: strftime directives	627
28.1	Class ERB: inline directives	653
28.2	Class OptionParser: option definitions	691

List of Figures

3.1	Variables hold object references.	39
4.1	How arrays are indexed	42
8.1	Ruby exception hierarchy	103
12.1	Roman numerals generation (with bugs)	145
12.2	Test::Unit assertions	154
13.1	Sample irb session	158
13.2	Comparing variable access costs using benchmark	163
16.1	Browse RDoc output for class counter	188
16.2	Browse RDoc output when source has comments	189
16.3	Using ri to read documentation	190
16.4	Document for class Proc generated by RDoc/ri	191
16.5	Ruby source file documented with RDoc	196
16.6	C source file documented with RDoc	198
16.7	Sample program using RDoc::usage	201
16.8	Help generated by sample program	202
17.1	MomLog package structure	220
18.1	Sample CGI Form	225
18.2	Erb processing a file with loops	232
19.1	Drawing on a Tk Canvas	248
21.1	Wrapping objects around C data types	272
21.2	Building an extension	283
22.1	State transitions for boolean range	327
24.1	A basic object, with its class and superclass	363
24.2	Adding a metaclass to Guitar	364
24.3	Adding a virtual class to an object	367
24.4	An included module and its proxy class	369
27.1	Standard exception hierarchy	441
27.2	Method#arity in action	523

Foreword to the First Edition

Man is driven to create; I know I really love to create things. And while I'm not good at painting, drawing, or music, I can write software.

Shortly after I was introduced to computers, I became interested in programming languages. I believed that an ideal programming language must be attainable, and I wanted to be the designer of it. Later, after gaining some experience, I realized that this kind of ideal, all-purpose language might be more difficult than I had thought. But I was still hoping to design a language that would work for most of the jobs I did everyday. That was my dream as a student.

Years later I talked with colleagues about scripting languages, their power and possibility. As an object-oriented fan for more than fifteen years, it seemed to me that OO programming was very suitable for scripting too. I did some research on the 'net for a while, but the candidates I found, Perl and Python, were not exactly what I was looking for. I wanted a language more powerful than Perl and more object-oriented than Python.

Then, I remembered my old dream and decided to design my own language. At first I was just toying around with it at work. But gradually it grew to be a tool good enough to replace Perl. I named it *Ruby*—after the precious red stone—and released it to the public in 1995.

Since then a lot of people have become interested in Ruby. Believe it or not, Ruby is actually more popular than Python in Japan right now. I hope that eventually it will be just as well received all over the world.

I believe that the purpose of life is, at least in part, to be happy. Based on this belief, Ruby is designed to make programming not only easy but also fun. It allows you to concentrate on the creative side of programming, with less stress. If you don't believe me, read this book and try Ruby. I'm sure you'll find out for yourself.

I'm very thankful to the people who have joined the Ruby community; they have helped me a lot. I almost feel like Ruby is one of my children, but in fact, it is the result of the

combined efforts of many people. Without their help, Ruby could never have become what it is.

I am especially thankful to the authors of this book, Dave Thomas and Andy Hunt. Ruby has never been a well-documented language. Because I have always preferred writing programs over writing documents, the Ruby manuals tend to be less thorough than they should be. You had to read the source to know the exact behavior of the language. But now Dave and Andy have done the work for you.

They became interested in a lesser-known language from the Far East. They researched it, read thousands of lines of source code, wrote uncountable test scripts and e-mails, clarified the ambiguous behavior of the language, found bugs (and even fixed some of them), and finally compiled this great book. Ruby is certainly well documented now!

Their work on this book has not been trivial. While they were writing it, I was modifying the language itself. But we worked together on the updates, and this book is as accurate as possible.

It is my hope that both Ruby and this book will serve to make your programming easy and enjoyable. Have fun!

Yukihiro Matsumoto, a.k.a. “Matz”
まつもと ゆきひろ
Japan, October 2000

Foreword to the Second Edition

No one in 1993 would have believed that an object-oriented language created by a Japanese amateur language designer would end up being used worldwide and that the language would become almost as popular as Perl. It was insane. I admit that. I didn't believe it either.

But it happened, far exceeding my expectations. It was caused—at least in part—by the first edition of this book. The famous Pragmatic Programmers chose a dynamic language that was virtually unknown to anyone outside of Japan and wrote a good book about it. It was just like a miracle.

That's now history. The future starts now. We have the second edition of *Programming Ruby*, which is better than the first one. It's no longer a miracle. This time, the grown-up Ruby community helped to develop the book. I just needed to sit and watch the community working together.

I really appreciate the Pragmatic Programmers, Dave Thomas and Andy Hunt, and other people from the community who helped with this book (guys, sorry for not naming you personally). I love the friendliness of the Ruby community. It's the best software community I have ever seen. I also appreciate every programmer in the world who uses Ruby.

The stone has started rolling. It will become a great mountain and fill the whole earth.

Yukihiro Matsumoto, a.k.a. “Matz”

まつもと ゆきひろ

Japan, August 2004

Preface

This book is the second edition of the PickAxe, as *Programming Ruby* is known to Rubyists. It is a tutorial and reference for the Ruby programming language. If you have the first edition, you'll find that this version is a significant rewrite.

When Andy and I wrote the first edition, we had to explain the background and appeal of Ruby. Among other things, we wrote “When we discovered Ruby, we realized that we'd found what we'd been looking for. More than any other language with which we have worked, Ruby *stays out of your way*. You can concentrate on solving the problem at hand, instead of struggling with compiler and language issues. That's how it can help you become a better programmer: by giving you the chance to spend your time creating solutions for your users, not for the compiler.”

That belief is even stronger today. Four years later. Ruby is still our language of choice: I use it for client applications, I use it to run our publishing business, and I use it for all those little programming jobs I do just to get things running smoothly.

In those four years, Ruby has progressed nicely. A large number of methods have been added to the built-in classes and modules, and the size of the standard library (those libraries included in the Ruby distribution) has grown tremendously. The community now has a standard documentation system (RDoc), and RubyGems may well become the system of choice for packaging Ruby code for distribution.

This change has been wonderful, but it left the original PickAxe looking a tad dated. This book remedies that: like its predecessor, it is written for the very latest version of Ruby.

Ruby Versions

This version of the PickAxe documents Ruby 1.8 (and in particular covers changes incorporated into Ruby 1.8.2).¹

1. Ruby version numbering follows the same scheme used for many other open-source projects. Releases with even subversion numbers—1.6, 1.8, and so on—are stable, public releases. These are the releases that are prepackaged and made available on the various Ruby Web sites. Development versions of the software

Exactly what version of Ruby did I use to write this book? Let's ask Ruby.

```
% ruby -v
ruby 1.8.2 (2004-08-24) [powerpc-darwin7.5.0]
```

This illustrates an important point. Most of the code samples you see in this book are actually executed each time I format the book. When you see some output from a program, that output was produced by running the code and inserting the results back into the book.

Changes in the Book

Apart from the updates to support Ruby 1.8, you'll find that the book has changed somewhat from the original edition.

In the first half of the book, I've added six new chapters. *Getting Started* is a more complete introduction to getting up-and-running with Ruby than we had in the first book. The second new chapter, *Unit Testing*, reflects a growing emphasis on using testing among Rubyists. Three new chapters cover tools for the Ruby programmer: *irb* for experimenting with Ruby, *RDoc* for documenting your code, and *RubyGems* for packing code for distribution. Finally, a new chapter covers *duck typing*, that slightly slippery philosophy of programming that fits in so well with the ideas behind Ruby.

That's not all that's new. You'll also find that the chapter on threads has been extended significantly with a discussion on synchronization and that the chapter on writing Ruby extensions has been largely rewritten. The chapter on Web programming now discusses alternative templating systems and has a section on SOAP. The language reference chapter has been significantly extended (particularly when dealing with the new rules for blocks, procs, breaks, and returns).

The next quarter of the book, which documents the built-in classes and modules, has more than 250 significant changes. Many of them are new methods, some are deprecated old methods, and some are methods with significant new behavior. You'll also find a number of new modules and classes documented.

Finally, the book includes a section on the standard library. The library has grown extensively since Ruby 1.6 and is now so big that I couldn't document it to any level of detail without making the book thousands of pages long. At the same time, the Ruby Documentation project has been busy adding RDoc documentation to the library source itself. (I explain RDoc in Chapter 16 on page 187.) This means that you will increasingly be able to get accurate, up-to-date documentation on a library module

have odd subversion numbers, such as 1.7 and 1.9. These you'll have to download and build for yourself, as described on page 3.

using the `ri` utility that comes with your Ruby distribution. As a consequence of all this, I decided to change the style of the library documentation—it is now a road map to available libraries, showing code samples and describing the overall use. I’ll leave the lower-level details to RDoc.

1.8

Throughout the book I’ve tried to mark changes between 1.6 and 1.8 using a small symbol in the margin, like the one here. One change I didn’t make: I decided to continue to use the word *we* when talking about the authors in the body of the book. Many of the words there come from the first edition, and I certainly don’t want to claim any credit for Andy’s work on that book.

In all, this book is a significant overhaul of the first version. I hope you find it useful.

Resources

Visit the Ruby Web site <http://www.ruby-lang.org> to see what’s new. Chat with other Ruby users on the newsgroup or mailing lists (see Appendix C).

And I’d certainly appreciate hearing from you. Comments, suggestions, errors in the text, and problems in the examples are all welcome. E-mail us at

`rubybook@pragmaticprogrammer.com`

If you tell us about errors in the book, I’ll add them to the errata list at

<http://www.pragmaticprogrammer.com/titles/ruby/errata.html>

You’ll find links to the source code for almost all the book’s example code at

<http://www.pragmaticprogrammer.com/titles/ruby>

Acknowledgments

For the second edition of the PickAxe, I asked on the Ruby mailing list if anyone would consider helping review the text. I was overwhelmed with the response: almost one hundred people volunteered. To keep it manageable, I had to restrict the list on a first-come basis. Even so, my wonderful reviewers produced more than 1.5Mb of review text. These folks picked on everything, from misplaced commas to missing methods. I couldn’t have gotten better help. So a big “thank you” to Richard Amacker, David A. Black, Tony Bowden, James Britt, Warren Brown, Mike Clark, Ryan Davis (thanks for the Japanese PDF!), Guy Decoux, Friedrich Dominicus, Thomas Enebo, Chad Fowler, Hal Fulton, Ben Giddings, Johan Holmberg, Andrew Johnson, Rich Kilmer, Robert Klemme, Yukihiro Matsumoto, Marcel Molina Jr., Roeland Moors, Michael Neumann,

Paul Rogers, Sean Russell, Hugh Sasse, Gavin Sinclair, Tanaka Akira, Juliet Thomas, Glenn Vanderburg, Koen Vervloesem, and Austin Ziegler.

Chad Fowler wrote the chapter on RubyGems. In fact, he wrote it twice. The first time, he was on vacation in Europe. On his way home, his Powerbook was stolen, and he lost all his work. So, when he got back, he cheerfully sat down and did it all again. I can't thank him enough.

Kim Wimpsett had the unenviable job of copyediting the book. She did a tremendous job (and in record time), which was made even more amazing by both the volume of jargon in the book and by my inability to string together more than two words without breaking one or more rules of grammar. Ed Giddens did a great job creating the cover, which nicely blends the old with the new. Thanks to you both!

Finally, I'm still deeply indebted to Yukihiro "Matz" Matsumoto, the creator of Ruby. Throughout this period of growth and change, he has remained helpful, cheery, and dedicated to polishing this gem of a language. The friendly and open spirit of the Ruby community is a direct reflection of the person at its center.

Thank you all. Domo arigato gozaimasu.

Dave Thomas

THE PRAGMATIC PROGRAMMERS

<http://www.pragmaticprogrammer.com>

Notation Conventions

Throughout this book, we use the following typographic notations.

Literal code examples are shown using a typewriter-like font.

```
class SampleCode
  def run
    #...
  end
end
```

Within the text, `Fred#do_something` is a reference to an instance method (in this case `do_something`) of class `Fred`, `Fred.new`² is a class method, and `Fred::EOF` is a class constant. The decision to use a hash character to indicate instance methods was a tough one: it isn't valid Ruby syntax, but we thought that it was important to differentiate between the instance and class methods of a particular class. When you see us write `File.read`, you know we're talking about the class method `read`. When instead we write `File#read`, we're referring to the instance method `read`.

The book contains many snippets of Ruby code. Where possible, we've tried to show what happens when they run. In simple cases, we show the value of expressions on the same line as the expression. For example:

```
a = 1
b = 2
a + b → 3
```

Here, you can see that the result of evaluating `a + b` is the value 3, shown to the right of the arrow. Note that if you simply run this program, you wouldn't see the value 3 output—you'd need to use a method such as `puts` to write it out.

At times, we're also interested in the values of assignment statements, in which case we'll show them.

```
a = 1 → 1
b = 2 → 2
a + b → 3
```

If the program produces more complex output, we show it below the program code.

```
3.times { puts "Hello!" }
```

produces:

```
Hello!
Hello!
Hello!
```

2. In some other Ruby documentation, you may see class methods written as `Fred::new`. This is perfectly valid Ruby syntax; we just happen to think that `Fred.new` is less distracting to read.

In some of the library documentation, we wanted to show where spaces appear in the output. You'll see these spaces as “`␣`” characters.

Command-line invocations are shown with literal text in a Roman font, and parameters you supply are shown in an *italic* font. Optional elements are shown in large square brackets.

```
ruby [ flags ... ] [ progrname ] [ arguments ... ]
```

Road Map

The main text of this book has four separate parts, each with its own personality, and each addressing different aspects of the Ruby language.

In Part I, *Facets of Ruby*, you'll find a Ruby tutorial. It starts with some notes on getting Ruby running on your system followed by a short chapter on some of the terminology and concepts that are unique to Ruby. This chapter also includes enough basic syntax so that the other chapters will make sense. The rest of the tutorial is a top-down look at the language. There we talk about classes and objects, types, expressions, and all the other things that make up the language. We end with chapters on unit testing and digging yourself out when trouble strikes.

One of the great things about Ruby is how well it integrates with its environment. Part II, *Ruby in Its Setting*, investigates this. Here you'll find practical information on using Ruby: using the interpreter options, using irb, documenting your Ruby code, and packaging your Ruby gems so that others can enjoy them. You'll also find tutorials on some common Ruby tasks: using Ruby with the Web, creating GUI applications using Tk, and using Ruby in a Microsoft Windows environment (including wonderful things such as native API calls, COM integration, and Windows Automation). And you'll discover just how easy it is to extend Ruby and to embed Ruby within your own code.

Part III, *Ruby Crystallized*, contains more advanced material. Here you'll find all the gory details about the language, the concept of *duck typing*, the metaclass model, tainting, reflection, and marshaling. You could probably speed-read this the first time through, but we think you'll come back to it as you start to use Ruby in earnest.

The *Ruby Library Reference* is Part IV. It's big. We document more than 950 methods in more than 48 built-in classes and modules (up from 800 methods in 40 classes and modules in the previous edition). On top of that, we now document the library modules that are included in the standard Ruby distribution (98 of them).

1.8

So, how should you read this book? Well, depending on your level of expertise with programming in general, and OO in particular, you may initially want to read just a few portions of the book. Here are our recommendations.

If you're a beginner, you may want to start with the tutorial material in Part I. Keep the library reference close at hand as you start to write programs. Get familiar with

the basic classes such as `Array`, `Hash`, and `String`. As you become more comfortable in the environment, you may want to investigate some of the more advanced topics in Part III.

If you're already comfortable with Perl, Python, Java, or Smalltalk, then we suggest reading Chapter 1 on page 2, which talks about installing and running Ruby, followed by the introduction in Chapter 2. From there, you may want to take the slower approach and keep going with the tutorial that follows, or you can skip ahead to the gritty details starting in Part III, followed by the library reference in Part IV.

Experts, gurus, and “I-don’t-need-no-stinking-tutorial” types can dive straight into the language reference in Chapter 22, which begins on page 302, skim the library reference, then use the book as a (rather attractive) coffee coaster.

Of course, nothing is wrong with just starting at the beginning and working your way through page by page.

And don’t forget, if you run into a problem that you can’t figure out, help is available. See Appendix C, beginning on page 758, for more information.

Part I

Facets of Ruby

Getting Started

Before we start talking about the Ruby language, it'd be useful if we helped you get Ruby running on your computer. That way you can try sample code and experiment on your own as you read along. We'll also show you some different ways to run Ruby.

Installing Ruby

Quite often, you won't even need to download Ruby. It now comes preinstalled on many Linux distributions, and Mac OS X includes Ruby (although the version of Ruby preinstalled on OS X is normally several minor releases behind the current Ruby version). Try typing **ruby -v** at a command prompt—you may be pleasantly surprised.

If you don't already have Ruby on your system, or if you'd like to upgrade to a newer version, you can install it pretty simply. But first, you have a choice to make: go for a binary distribution, or build Ruby from source?

Binary Distributions

A binary distribution of Ruby simply works out of the box. You install it, and it runs. Binary distributions are prebuilt for a particular operating environment and are convenient if you don't want to mess around with building Ruby from source. The downside of a binary distribution is that you have to take it as given: it may be a minor release or two behind the leading edge, and it may not have the optional libraries that you might want. If you can live with that, you'll need to find a binary distribution for your operating system and machine architecture.

For RPM-based Linux systems, you can search on <http://www.rpmfind.net> for a suitable Ruby RPM. Enter **ruby** as a search term, and select from the listed version numbers, architectures, and distributions. For example, `ruby-1.8.2.i386` is a binary distribution of Ruby 1.8.2 for Intel x86 architectures.

For Debian dpkg-based Linux systems, you can use the `apt-get` system to find and install Ruby. You can use the `apt-cache` command to search for Ruby packages.

```
# apt-cache search ruby interpreter
libapache-mod-ruby - Embedding Ruby in the Apache web server
liberb-ruby1.6 - Tiny eRuby for Ruby 1.6
liberb-ruby1.8 - Tiny eRuby
ruby - An interpreter of object-oriented scripting language Ruby
ruby1.7 - Interpreter of object-oriented scripting language Ruby
ruby1.8 - Interpreter of object-oriented scripting language Ruby
```

You can install any of these packages using `apt-get`.

```
# apt-get install ruby1.8
Reading Package Lists... Done
Building Dependency Tree... Done
The following extra packages will be installed:
  libruby1.8
Suggested packages:
  ruby1.8-examples
The following NEW packages will be installed:
  libruby1.8 ruby1.8
  :       :       :
```

Note that you have to have superuser access to install global packages on a Unix or Linux box, which is why we show the prompt as a `#`.

If you're running on Microsoft Windows, you'll find the home page of the One-Click Installer at <http://rubyinstaller.rubyforge.org>.

Building Ruby from Source

Because Ruby is an open-source project, you can download the source code to the interpreter and build it on your own system. Compared to using a binary distribution, this gives you a lot more control over where things go, and you can keep your installation totally up-to-date. The downside is that you're taking on the responsibility of managing the build and installation process. This isn't onerous, but it can be scary if you've never installed an open-source application from source.

The first thing to do is to download the source. This comes in three flavors, all from <http://www.ruby-lang.org>.

1. The stable release in *tarball* format. A tarball is an archive file, much like a *zip* file. Click the *Download Ruby* link, and then click the *stable release* link.
2. The *stable snapshot*. This is a tarball, created nightly, of the latest source code in Ruby's stable development branch. The stable branch is intended for production code and in general will be reliable. However, because the snapshot is taken daily, new features may not have received thorough testing yet—the stable tarball in item (1) will be generally more reliable.

3. The *nightly development snapshot*. This is again a tarball, created nightly. Unlike the stable code in (1) and (2), this code is leading edge, as it is taken from the head of the development branch. Expect things to be broken in here.

If you plan on downloading either of the nightly snapshots regularly, it may be easier to subscribe to the source repository directly. The sidebar on the next page gives more details.

Once you've loaded a tarball, you'll have to expand the archive into its constituent files. Use the `tar` command for this (if you don't have `tar` installed, you can try using another archiving utility, as many now support tar-format files).

```
% tar xzf snapshot.tar.gz
ruby/
ruby/bcc32/
ruby/bcc32/Makefile.sub
ruby/bcc32/README.bcc32
:      :      :
```

This installs the Ruby source tree in the subdirectory `ruby/`. In that directory you'll find a file named `README`, which explains the installation procedure in detail. To summarize, you build Ruby on POSIX-based systems using the same four commands you use for most other open-source applications: `./configure`, `make`, `make test`, and `make install`. You can build Ruby under other environments (including Windows) by using a POSIX emulation environment such as `cygwin`¹ or by using native compilers—see `README.win32` in the distribution's `win32` subdirectory as a starting point.

Source Code from This Book

We've made the source code from this book available for download from our web site at <http://pragmaticprogrammer.com/titles/ruby/code>. Sometimes, the listings of code in the book correspond to a complete source file. Other times, the book contains just a part of the source in a file—the program file may contain additional scaffolding to make the code compile.

Running Ruby

Now that Ruby is installed, you'd probably like to run some programs. Unlike compiled languages, you have two ways to run Ruby—you can type in code interactively, or you can create program files and run them. Typing in code interactively is a great way to experiment with the language, but for code that's more complex, or that you will want to run more than once, you'll need to create program files and run them.

1. See <http://www.cygwin.com> for details.

The Very Latest Ruby

For those who just have to be on the very latest, hot-off-the-press and *untested* cutting edge (as we were while writing this book), you can get development versions straight from the developers' working repository.

The Ruby developers use CVS (Concurrent Version System, freely available from <https://www.cvshome.org>) as their revision control system. You can check files out as an anonymous user from their archive by executing the following CVS commands:

```
% cvs -z4 -d :pserver:anonymous@cvs.ruby-lang.org:/src ↵
login
(Logging in to anonymous@cvs.ruby-lang.org)
CVS password: [ENTER]
% cvs -z4 -d :pserver:anonymous@cvs.ruby-lang.org:/src ↵
checkout ruby
```

The complete source code tree, just as the developers last left it, will now be copied to a `ruby` subdirectory on your machine.

This command will check out the head of the development tree. If you want the Ruby 1.8 branch, add `-r ruby_1_8` after the word `checkout` in the second command.

If you use the CVSup mirroring utility (conveniently available from <http://www.cvsup.org>), you can find Ruby supfiles on the `ruby-lang` site at <http://cvs.ruby-lang.org/cvsup/>.

Interactive Ruby

One way to run Ruby interactively is simply to type **ruby** at the shell prompt. Here we typed in the single `puts` expression and an end-of-file character (which is Ctrl+D on our system). This process works, but it's painful if you make a typo, and you can't really see what's going on as you type.

```
% ruby
puts "Hello, world!"
^D
Hello, world!
```

For most folks, *irb*—Interactive Ruby—is the tool of choice for executing Ruby interactively. `irb` is a Ruby Shell, complete with command-line history, line-editing capabilities, and job control. (In fact, it has its own chapter beginning on page 174.) You run `irb` from the command line. Once it starts, just type in Ruby code. It will show you the value of each expression as it evaluates it.

```
% irb
irb(main):001:0> def sum(n1, n2)
irb(main):002:1>   n1 + n2
irb(main):003:1> end
=> nil
irb(main):004:0> sum(3, 4)
=> 7
irb(main):005:0> sum("cat", "dog")
=> "catdog"
```

We recommend that you get familiar with irb so you can try some of our examples interactively.

There's a trick when you want to use irb to try our example code that's already in a file. Say, for example, you wanted to try the Fibonacci module listed on page 196. You can do this from within irb by loading in the program file and then calling the methods it contains. In this case, the program file is in code/rdoc/fib_example.rb.

```
% irb
irb(main):001:0> load "code/rdoc/fib_example.rb"
=> true
irb(main):002:0> Fibonacci.upto(20)
=> [1, 1, 2, 3, 5, 8, 13]
```

Ruby Programs

You can run a Ruby program from a file as you would any other shell script, Perl program, or Python program. Simply run the Ruby interpreter, giving it the script name as an argument.

```
% ruby myprog.rb
```

You can also use the Unix “shebang” notation as the first line of the program file.²

```
#!/usr/local/bin/ruby -w
puts "Hello, world!"
```

If you make this source file executable (using, for instance, `chmod +x myprog.rb`), Unix lets you run the file as a program.

```
% ./myprog.rb
Hello, world!
```

You can do something similar under Microsoft Windows using file associations, and you can run Ruby GUI applications by double-clicking their names in Explorer.

2. If your system supports it, you can avoid hard-coding the path to Ruby in the “shebang” line by using `#!/usr/bin/env ruby`, which will search your path for ruby and then execute it.

Ruby Documentation: RDoc and ri

As the volume of the Ruby libraries has grown, it has become impossible to document them all in one book; the standard library that comes with Ruby now contains more than 9,000 methods. Fortunately, an alternative to paper documentation exists for these methods (and classes and modules). Many are now documented internally using a system called *RDoc*.

If a source file is documented using RDoc, its documentation can be extracted and converted into HTML and ri formats.

Several sites on the Web contain a complete set of the RDoc documentation for Ruby, but <http://www.ruby-doc.org> is probably the best known. Browse on over, and you should be able to find at least some form of documentation for any Ruby library. They're adding new documentation all the time.

The ri tool is a local, command-line viewer for this same documentation. Most Ruby distributions now also install the resources used by the ri program.

To find the documentation for a class, type **ri *ClassName***. For example, the following lists the summary information for the GC class. (For a list of classes with ri documentation, type **ri -c**.)

```
% ri GC
----- Class: GC
  The GC module provides an interface to Ruby's mark and sweep
  garbage collection mechanism. Some of the underlying methods are
  also available via the ObjectSpace module.
-----

Class methods:
  disable, enable, start

Instance methods:
  garbage_collect
```

For information on a particular method, give its name as a parameter.

```
% ri enable
----- GC::enable
  GC.enable => true or false
-----

  Enables garbage collection, returning true if garbage collection
  was previously disabled.

  GC.disable #=> false
  GC.enable  #=> true
  GC.enable  #=> false
```

If the method you pass to `ri` occurs in more than one class or module, `ri` will list all of the alternatives. Reissue the command, prefixing the method name with the name of the class and a dot.

```
% ri start
More than one method matched your request. You can refine
your search by asking for information on one of:

    Date#new_start, Date#start, GC::start, Logger::Application#start,
    Thread::start

% ri GC.start
----- GC::start
GC.start                => nil
gc.garbage_collect      => nil
ObjectSpace.garbage_collect => nil
-----

Initiates garbage collection, unless manually disabled.
```

For general help on using `ri`, type “`ri --help`”. In particular you might want to experiment with the “`--format`” option, which tells `ri` how to render decorated text (such as section headings). If your terminal program supports ANSI escape sequences, using “`--format ansi`” will generate a nice, colorful display. Once you find a set of options you like, you can set them into the `RI` environment variable. Using my shell (`zsh`), this would be done using:

```
% export RI="--format ansi --width 70"
```

If a class or module isn’t yet documented in `RDoc` format, ask the friendly folks over at `suggestions@ruby-doc.org` to consider adding it.

All this command-line hacking may seem a tad off-putting if you’re not a regular visitor to the shell prompt. But, in reality, it isn’t that difficult, and the power you get from being able to string together commands this way is often surprising. Stick with it, and you’ll be well on your way to mastering both Ruby and your computer.

Ruby.new

When we originally designed this book, we had a grand plan (we were younger then). We wanted to document the language from the top down, starting with classes and objects and ending with the nitty-gritty syntax details. It seemed like a good idea at the time. After all, most everything in Ruby is an object, so it made sense to talk about objects first.

Or so we thought.

Unfortunately, it turns out to be difficult to describe a language that way. If you haven't covered strings, `if` statements, assignments, and other details, it's difficult to write examples of classes. Throughout our top-down description, we kept coming across low-level details we needed to cover so that the example code would make sense.

So, we came up with another grand plan (they don't call us pragmatic for nothing). We'd still describe Ruby starting at the top. But before we did that, we'd add a short chapter that described all the common language features used in the examples along with the special vocabulary used in Ruby, a kind of minitutorial to bootstrap us into the rest of the book.

Ruby Is an Object-Oriented Language

Let's say it again. Ruby is a genuine object-oriented language. Everything you manipulate is an object, and the results of those manipulations are themselves objects. However, many languages make the same claim, and their users often have a different interpretation of what *object-oriented* means and a different terminology for the concepts they employ.

So, before we get too far into the details, let's briefly look at the terms and notation that *we'll* be using.

When you write object-oriented code, you're normally looking to model concepts from the real world in your code. Typically during this modeling process you'll discover categories of things that need to be represented in code. In a jukebox, the concept of a "song" could be such a category. In Ruby, you'd define a *class* to represent each of these entities. A class is a combination of state (for example, the name of the song) and methods that use that state (perhaps a method to play the song).

Once you have these classes, you'll typically want to create a number of *instances* of each. For the jukebox system containing a class called *Song*, you'd have separate instances for popular hits such as "Ruby Tuesday," "Enveloped in Python," "String of Pearls," "Small Talk," and so on. The word *object* is used interchangeably with *class instance* (and being lazy typists, we'll probably be using the word *object* more frequently).

In Ruby, these objects are created by calling a *constructor*, a special method associated with a class. The standard constructor is called *new*.

```
song1 = Song.new("Ruby Tuesday")
song2 = Song.new("Enveloped in Python")
# and so on
```

These instances are both derived from the same class, but they have unique characteristics. First, every object has a unique *object identifier* (abbreviated as *object ID*). Second, you can define *instance variables*, variables with values that are unique to each instance. These instance variables hold an object's state. Each of our songs, for example, will probably have an instance variable that holds the song title.

Within each class, you can define *instance methods*. Each method is a chunk of functionality that may be called from within the class and (depending on accessibility constraints) from outside the class. These instance methods in turn have access to the object's instance variables and hence to the object's state.

Methods are invoked by sending a message to an object. The message contains the method's name, along with any parameters the method may need.¹ When an object receives a message, it looks into its own class for a corresponding method. If found, that method is executed. If the method *isn't* found... well, we'll get to that later.

This business of methods and messages may sound complicated, but in practice it is very natural. Let's look at some method calls.

```
"gin joint".length → 9
"Rick".index("c") → 2
-1942.abs → 1942
sam.play(song) → "duh dum, da dum de dum ..."
```

1. This idea of expressing method calls in the form of messages comes from Smalltalk.

(Remember, in the code examples in this book, the arrows show the value of an expression. The result of executing `-1942.abs` is `1942`. If you just typed this code into a file and ran it using Ruby, you'd see no output, because we didn't tell Ruby to display anything. If you're using `irb`, you'd see the values we show in the book.)

Here, the thing before the period is called the *receiver*, and the name after the period is the method to be invoked. The first example asks a string for its length, and the second asks a different string to find the index of the letter *c*. The third line has a number calculate its absolute value. Finally, we ask Sam to play us a song.

It's worth noting here a major difference between Ruby and most other languages. In (say) Java, you'd find the absolute value of some number by calling a separate function and passing in that number. You could write

```
number = Math.abs(number)    // Java code
```

In Ruby, the ability to determine an absolute value is built into numbers—they take care of the details internally. You simply send the message `abs` to a number object and let it do the work.

```
number = number.abs
```

The same applies to all Ruby objects: in C you'd write `strlen(name)`, but in Ruby it's `name.length`, and so on. This is part of what we mean when we say that Ruby is a genuine object-oriented language.

Some Basic Ruby

Not many people like to read heaps of boring syntax rules when they're picking up a new language, so we're going to cheat. In this section we'll hit some of the highlights—the stuff you'll just *have* to know if you're going to write Ruby programs. Later, in [Chapter 22](#), which begins on [page 302](#), we'll go into all the gory details.

Let's start with a simple Ruby program. We'll write a method that returns a cheery, personalized greeting. We'll then invoke that method a couple of times.

```
def say_goodnight(name)
  result = "Good night, " + name
  return result
end

# Time for bed...
puts say_goodnight("John-Boy")
puts say_goodnight("Mary-Ellen")
```

As the example shows, Ruby syntax is clean. You don't need semicolons at the ends of statements as long as you put each statement on a separate line. Ruby comments start with a `#` character and run to the end of the line. Code layout is pretty much up to

you; indentation is not significant (but using two-character indentation will make you friends in the community if you plan on distributing your code).

Methods are defined with the keyword `def`, followed by the method name (in this case, `say_goodnight`) and the method's parameters between parentheses. (In fact, the parentheses are optional, but we like to use them.) Ruby doesn't use braces to delimit the bodies of compound statements and definitions. Instead, you simply finish the body with the keyword `end`. Our method's body is pretty simple. The first line concatenates the literal string `"Good night, "` and the parameter name and assigns the result to the local variable `result`. The next line returns that result to the caller. Note that we didn't have to declare the variable `result`; it sprang into existence when we assigned to it.

Having defined the method, we call it twice. In both cases we pass the result to the method `puts`, which simply outputs its argument followed by a newline (moving on to the next line of output).

```
    Good night, John-Boy
    Good night, Mary-Ellen
```

The line `puts say_goodnight("John-Boy")` contains two method calls, one to the method `say_goodnight` and the other to the method `puts`. Why does one call have its arguments in parentheses while the other doesn't? In this case it's purely a matter of taste. The following lines are both equivalent.

```
    puts say_goodnight("John-Boy")
    puts(say_goodnight("John-Boy"))
```

However, life isn't always that simple, and precedence rules can make it difficult to know which argument goes with which method invocation, so we recommend using parentheses in all but the simplest cases.

This example also shows some Ruby string objects. You have many ways to create a string object, but probably the most common is to use string literals: sequences of characters between single or double quotation marks. The difference between the two forms is the amount of processing Ruby does on the string while constructing the literal. In the single-quoted case, Ruby does very little. With a few exceptions, what you type into the string literal becomes the string's value.

In the double-quoted case, Ruby does more work. First, it looks for substitutions—sequences that start with a backslash character—and replaces them with some binary value. The most common of these is `\n`, which is replaced with a newline character. When a string containing a newline is output, the `\n` forces a line break.

```
    puts "And good night,\nGrandma"
```

produces:

```
    And good night,
    Grandma
```

The second thing that Ruby does with double-quoted strings is expression interpolation. Within the string, the sequence `#{expression}` is replaced by the value of *expression*. We could use this to rewrite our previous method.

```
def say_goodnight(name)
  result = "Good night, #{name}"
  return result
end
puts say_goodnight('Pa')
```

produces:

```
Good night, Pa
```

When Ruby constructs this string object, it looks at the current value of `name` and substitutes it into the string. Arbitrarily complex expressions are allowed in the `#{...}` construct. Here we invoke the `capitalize` method, defined for all strings, to output our parameter with a leading uppercase letter.

```
def say_goodnight(name)
  result = "Good night, #{name.capitalize}"
  return result
end
puts say_goodnight('uncle')
```

produces:

```
Good night, Uncle
```

As a shortcut, you don't need to supply the braces when the expression is simply a global, instance, or class variable (which we'll talk about shortly).

```
$greeting = "Hello"      # $greeting is a global variable
@name      = "Prudence"  # @name is an instance variable
puts "$greeting, #@name"
```

produces:

```
Hello, Prudence
```

For more information on strings, as well as on the other Ruby standard types, see Chapter 5, which begins on page 55.

Finally, we could simplify this method some more. The value returned by a Ruby method is the value of the last expression evaluated, so we can get rid of the temporary variable and the return statement altogether.

```
def say_goodnight(name)
  "Good night, #{name}"
end
puts say_goodnight('Ma')
```

produces:

```
Good night, Ma
```

We promised that this section would be brief. We’ve got just one more topic to cover: Ruby names. For brevity, we’ll be using some terms (such as *class variable*) that we aren’t going to define here. However, by talking about the rules now, you’ll be ahead of the game when we actually come to discuss class variables and the like later.

Ruby uses a convention to help it distinguish the usage of a name: the first characters of a name indicate how the name is used. Local variables, method parameters, and method names should all start with a lowercase letter or with an underscore. Global variables are prefixed with a dollar sign (\$), and instance variables begin with an “at” sign (@). Class variables start with two “at” signs (@@). Finally, class names, module names, and constants must start with an uppercase letter. Samples of different names are given in Table 2.1 on the next page.

Following this initial character, a name can be any combination of letters, digits, and underscores (with the proviso that the character following an @ sign may not be a digit). However, by convention multiword instance variables are written with underscores between the words, and multiword class names are written in MixedCase (with each word capitalized).

Arrays and Hashes

Ruby’s arrays and hashes are indexed collections. Both store collections of objects, accessible using a key. With arrays, the key is an integer, whereas hashes support any object as a key. Both arrays and hashes grow as needed to hold new elements. It’s more efficient to access array elements, but hashes provide more flexibility. Any particular array or hash can hold objects of differing types; you can have an array containing an integer, a string, and a floating-point number, as we’ll see in a minute.

You can create and initialize a new array object using an *array literal*—a set of elements between square brackets. Given an array object, you can access individual elements by supplying an index between square brackets, as the next example shows. Note that Ruby array indices start at zero.

```
a = [ 1, 'cat', 3.14 ] # array with three elements
# access the first element
a[0] → 1
# set the third element
a[2] = nil
# dump out the array
a → [1, "cat", nil]
```

You may have noticed that we used the special value `nil` in this example. In many languages, the concept of *nil* (or *null*) means “no object.” In Ruby, that’s not the case; `nil` is an object, just like any other, that happens to represent nothing. Anyway, back to arrays and hashes.

Table 2.1. Example variable and class names

Local	Variables			Constants and Class Names
	Global	Instance	Class	
name	\$debug	@name	@@total	PI
fish_and_chips	\$CUSTOMER	@point_1	@@syntab	FeetPerMile
x_axis	\$_	@X	@@N	String
thx1138	\$plan9	@_	@@x_pos	MyClass
_26	\$Global	@plan9	@@SINGLE	JazzSong

Sometimes creating arrays of words can be a pain, what with all the quotes and commas. Fortunately, Ruby has a shortcut: %w does just what we want.

```
a = [ 'ant', 'bee', 'cat', 'dog', 'elk' ]
a[0] → "ant"
a[3] → "dog"
# this is the same:
a = %w{ ant bee cat dog elk }
a[0] → "ant"
a[3] → "dog"
```

Ruby hashes are similar to arrays. A hash literal uses braces rather than square brackets. The literal must supply two objects for every entry: one for the key, the other for the value.

For example, you may want to map musical instruments to their orchestral sections. You could do this with a hash.

```
inst_section = {
  'cello'    => 'string',
  'clarinet' => 'woodwind',
  'drum'     => 'percussion',
  'oboe'     => 'woodwind',
  'trumpet'  => 'brass',
  'violin'   => 'string'
}
```

The thing to the left of the => is the key, and that on the right is the corresponding value. Keys in a particular hash must be unique—you can’t have two entries for “drum.” The keys and values in a hash can be arbitrary objects—you can have hashes where the values are arrays, other hashes, and so on.

Hashes are indexed using the same square bracket notation as arrays.

```
inst_section['oboe'] → "woodwind"
inst_section['cello'] → "string"
inst_section['bassoon'] → nil
```

As the last example shows, a hash by default returns `nil` when indexed by a key it doesn't contain. Normally this is convenient, as `nil` means false when used in conditional expressions. Sometimes you'll want to change this default. For example, if you're using a hash to count the number of times each key occurs, it's convenient to have the default value be zero. This is easily done by specifying a default value when you create a new, empty hash.

```

    histogram = Hash.new(0)
    histogram['key1'] → 0
    histogram['key1'] = histogram['key1'] + 1
    histogram['key1'] → 1

```

Array and hash objects have lots of useful methods: see the discussion starting on page 40, and the reference sections starting on pages 406 and 471, for details.

Control Structures

Ruby has all the usual control structures, such as `if` statements and `while` loops. Java, C, and Perl programmers may well get caught by the lack of braces around the bodies of these statements. Instead, Ruby uses the keyword `end` to signify the end of a body.

```

    if count > 10
      puts "Try again"
    elsif tries == 3
      puts "You lose"
    else
      puts "Enter a number"
    end

```

Similarly, `while` statements are terminated with `end`.

```

    while weight < 100 and num_pallets <= 30
      pallet = next_pallet()
      weight += pallet.weight
      num_pallets += 1
    end

```

Most statements in Ruby return a value, which means you can use them as conditions. For example, the method `gets` returns the next line from the standard input stream or `nil` when end of file is reached. Because Ruby treats `nil` as a false value in conditions, you could write the following to process the lines in a file.

```

    while line = gets
      puts line.downcase
    end

```

Here, the assignment statement sets the variable `line` to either the next line of text or `nil`, and then the `while` statement tests the value of the assignment, terminating the loop when it is `nil`.

Ruby *statement modifiers* are a useful shortcut if the body of an `if` or `while` statement is just a single expression. Simply write the expression, followed by `if` or `while` and the condition. For example, here's a simple `if` statement.

```
if radiation > 3000
  puts "Danger, Will Robinson"
end
```

Here it is again, rewritten using a statement modifier.

```
puts "Danger, Will Robinson" if radiation > 3000
```

Similarly, a `while` loop such as

```
square = 2
while square < 1000
  square = square*square
end
```

becomes the more concise

```
square = 2
square = square*square while square < 1000
```

These statement modifiers should seem familiar to Perl programmers.

Regular Expressions

Most of Ruby's built-in types will be familiar to all programmers. A majority of languages have strings, integers, floats, arrays, and so on. However, regular expression support is typically built into only scripting languages, such as Ruby, Perl, and awk. This is a shame: regular expressions, although cryptic, are a powerful tool for working with text. And having them built in, rather than tacked on through a library interface, makes a big difference.

Entire books have been written about regular expressions (for example, *Mastering Regular Expressions* [Fri02]), so we won't try to cover everything in this short section. Instead, we'll look at just a few examples of regular expressions in action. You'll find full coverage of regular expressions starting on page 64.

A regular expression is simply a way of specifying a *pattern* of characters to be matched in a string. In Ruby, you typically create a regular expression by writing a pattern between slash characters (*/pattern/*). And, Ruby being Ruby, regular expressions are objects and can be manipulated as such.

For example, you could write a pattern that matches a string containing the text *Perl* or the text *Python* using the following regular expression.

```
/Perl|Python/
```

The forward slashes delimit the pattern, which consists of the two things we're matching, separated by a pipe character (`|`). This pipe character means "either the thing on the right or the thing on the left," in this case either *Perl* or *Python*. You can use parentheses within patterns, just as you can in arithmetic expressions, so you could also have written this pattern as

```
/P(erl|ython)/
```

You can also specify *repetition* within patterns. `/ab+c/` matches a string containing an *a* followed by one or more *b*'s, followed by a *c*. Change the plus to an asterisk, and `/ab*c/` creates a regular expression that matches one *a*, zero or more *b*'s, and one *c*.

You can also match one of a group of characters within a pattern. Some common examples are *character classes* such as `\s`, which matches a whitespace character (space, tab, newline, and so on); `\d`, which matches any digit; and `\w`, which matches any character that may appear in a typical word. A dot (`.`) matches (almost) any character. A table of these character classes appears on page 68.

We can put all this together to produce some useful regular expressions.

```
/\d\d:\d\d:\d\d/      # a time such as 12:34:56
/Perl.*Python/       # Perl, zero or more other chars, then Python
/Perl Python/        # Perl, a space, and Python
/Perl *Python/        # Perl, zero or more spaces, and Python
/Perl +Python/        # Perl, one or more spaces, and Python
/Perl\s+Python/      # Perl, whitespace characters, then Python
/Ruby (Perl|Python)/ # Ruby, a space, and either Perl or Python
```

Once you have created a pattern, it seems a shame not to use it. The match operator `=~` can be used to match a string against a regular expression. If the pattern is found in the string, `=~` returns its starting position, otherwise it returns `nil`. This means you can use regular expressions as the condition in `if` and `while` statements. For example, the following code fragment writes a message if a string contains the text *Perl* or *Python*.

```
if line =~ /Perl|Python/
  puts "Scripting language mentioned: #{line}"
end
```

The part of a string matched by a regular expression can be replaced with different text using one of Ruby's substitution methods.

```
line.sub(/Perl/, 'Ruby') # replace first 'Perl' with 'Ruby'
line.gsub(/Python/, 'Ruby') # replace every 'Python' with 'Ruby'
```

You can replace every occurrence of *Perl* and *Python* with *Ruby* using

```
line.gsub(/Perl|Python/, 'Ruby')
```

We'll have a lot more to say about regular expressions as we go through the book.

Blocks and Iterators

This section briefly describes one of Ruby's particular strengths. We're about to look at code blocks: chunks of code you can associate with method invocations, almost as if they were parameters. This is an incredibly powerful feature. One of our reviewers commented at this point: "This is pretty interesting and important, and so if you weren't paying attention before, you should probably start now." We'd have to agree.

You can use code blocks to implement callbacks (but they're simpler than Java's anonymous inner classes), to pass around chunks of code (but they're more flexible than C's function pointers), and to implement iterators.

Code blocks are just chunks of code between braces or between `do...end`.

```
{ puts "Hello" }      # this is a block
do                  ###
  club.enroll(person) # and so is this
  person.socialize   #
end                 ###
```

Why are there two kinds of delimiter? It's partly because sometimes one feels more natural to write than another. It's partly too because they have different precedences: the braces bind more tightly than the `do/end` pairs. In this book, we try to follow what is becoming a Ruby standard and use braces for single-line blocks and `do/end` for multiline blocks.

Once you've created a block, you can associate it with a call to a method. You do this by putting the start of the block at the end of the source line containing the method call. For example, in the following code, the block containing `puts "Hi"` is associated with the call to the method `greet`.

```
greet { puts "Hi" }
```

If the method has parameters, they appear before the block.

```
verbose_greet("Dave", "loyal customer") { puts "Hi" }
```

A method can then invoke an associated block one or more times using the Ruby `yield` statement. You can think of `yield` as being something like a method call that calls out to the block associated with the method containing the `yield`.

The following example shows this in action. We define a method that calls `yield` twice. We then call this method, putting a block on the same line, after the call (and after any arguments to the method).²

2. Some people like to think of the association of a block with a method as a kind of parameter passing. This works on one level, but it isn't really the whole story. You may be better off thinking of the block and the method as coroutines, which transfer control back and forth between themselves.

```

def call_block
  puts "Start of method"
  yield
  yield
  puts "End of method"
end
call_block { puts "In the block" }

```

produces:

```

Start of method
In the block
In the block
End of method

```

See how the code in the block (`puts "In the block"`) is executed twice, once for each call to `yield`.

You can provide parameters to the call to `yield`: these will be passed to the block. Within the block, you list the names of the arguments to receive these parameters between vertical bars (`|`).

```

def call_block
  yield("hello", 99)
end
call_block {|str, num| ... }

```

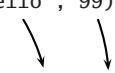

Code blocks are used throughout the Ruby library to implement iterators: methods that return successive elements from some kind of collection, such as an array.

```

animals = %w( ant bee cat dog elk ) # create an array
animals.each {|animal| puts animal } # iterate over the contents

```

produces:

```

ant
bee
cat
dog
elk

```

Let's look at how we could implement the `Array` class's `each` iterator that we used in the previous example. The `each` iterator loops through every element in the array, calling `yield` for each one. In pseudo-code, this may look like

```

# within class Array...
def each
  for each element # <-- not valid Ruby
    yield(element)
  end
end

```

Many of the looping constructs that are built into languages such as C and Java are simply method calls in Ruby, with the methods invoking the associated block zero or more times.

```
[ 'cat', 'dog', 'horse' ].each {|name| print name, " " }
5.times { print "*" }
3.upto(6) {|i| print i }
('a'..'e').each {|char| print char }
```

produces:

```
cat dog horse *****3456abcde
```

Here we ask the object 5 to call a block five times and then ask the object 3 to call a block, passing in successive values until it reaches 6. Finally, the range of characters from *a* to *e* invokes a block using the method `each`.

Reading and Writing

Ruby comes with a comprehensive I/O library. However, in most of the examples in this book we'll stick to a few simple methods. We've already come across two methods that do output. `puts` writes its arguments, adding a newline after each. `print` also writes its arguments, but with no newline. Both can be used to write to any I/O object, but by default they write to standard output.

Another output method we use a lot is `printf`, which prints its arguments under the control of a format string (just like `printf` in C or Perl).

```
printf("Number: %5.2f,\nString: %s\n", 1.23, "hello")
```

produces:

```
Number:  1.23,
String: hello
```

In this example, the format string `"Number: %5.2f,\nString: %s\n"` tells `printf` to substitute in a floating-point number (allowing five characters in total, with two after the decimal point) and a string. Notice the newlines (`\n`) embedded in the string; each moves the output onto the next line.

You have many ways to read input into your program. Probably the most traditional is to use the routine `gets`, which returns the next line from your program's standard input stream.

```
line = gets
print line
```

Ruby Escapes Its Past

In the old days Ruby borrowed a lot from the Perl language. One of these features is a certain “magic” when it comes to global variables, and probably no global is more magical than `$_`. For example, the `gets` method has a side effect: as well as returning the line just read, it also stores it into `$_`. If you call `print` with no argument, it prints the contents of `$_`. If you write an `if` or `while` statement with just a regular expression as the condition, that expression is matched against `$_`. As a result of all this magic, you could write the following program to look for all lines in a file containing the text *Ruby*.

```
while gets
  if /Ruby/
    print
  end
end
```

However, this style of Ruby programming is rapidly falling out of fashion with purists. As one of these purists happens to be Matz, you’ll now find that Ruby issues warnings for many of these special uses: expect to see these features go away in the future.

That doesn’t mean you have to write more verbose programs. The “Ruby way” to write this would be to use an iterator and the predefined object `ARGF`, which represents the program’s input files.

```
ARGF.each {|line| print line if line =~ /Ruby/ }
```

You could write it even more concisely.

```
print ARGF.grep(/Ruby/)
```

In general, there’s a move away from some of the Perlisms in the Ruby community. If you run your programs with the `-w` flag to enable warnings (you *do* run with warnings enabled, don’t you?), you’ll find the Ruby interpreter catches most of them.

Onward and Upward

That’s it. We’ve finished our lightning-fast tour of some of the basic features of Ruby. We’ve had a look at objects, methods, strings, containers, and regular expressions, seen some simple control structures, and looked at some rather nifty iterators. We hope this chapter has given you enough ammunition to be able to attack the rest of this book.

Time to move on, and up—up to a higher level. Next, we’ll be looking at classes and objects, things that are at the same time both the highest-level constructs in Ruby and the essential underpinnings of the entire language.

Classes, Objects, and Variables

From the examples we've shown so far, you may be wondering about our earlier assertion that Ruby is an object-oriented language. Well, this chapter is where we justify that claim. We're going to be looking at how you create classes and objects in Ruby and at some of the ways in which Ruby is more powerful than most object-oriented languages. Along the way, we'll be implementing part of our next billion-dollar product, the Internet Enabled Jazz and Bluegrass jukebox.

After months of work, our highly paid Research and Development folks have determined that our jukebox needs *songs*. So it seems like a good idea to start by setting up a Ruby class that represents things that are songs. We know that a real song has a name, an artist, and a duration, so we'll want to make sure that the song objects in our program do, too.

We'll start by creating the basic class `Song`,¹ which contains just a single method, `initialize`.

```
class Song
  def initialize(name, artist, duration)
    @name      = name
    @artist    = artist
    @duration  = duration
  end
end
```

`initialize` is a special method in Ruby programs. When you call `Song.new` to create a new `Song` object, Ruby allocates some memory to hold an uninitialized object and

1. As we mentioned on page 14, class names start with an uppercase letter, and method names normally start with a lowercase letter.

then calls that object's `initialize` method, passing in any parameters that were passed to `new`. This gives you a chance to write code that sets up your object's state.

For class `Song`, the `initialize` method takes three parameters. These parameters act just like local variables within the method, so they follow the local variable naming convention of starting with a lowercase letter.

Each object represents its own song, so we need each of our `Song` objects to carry around its own song name, artist, and duration. This means we need to store these values as *instance variables* within the object. Instance variables are accessible to all the methods in an object, and each object has its own copy of its instance variables.

In Ruby, an instance variable is simply a name preceded by an “at” sign (`@`). In our example, the parameter `name` is assigned to the instance variable `@name`, `artist` is assigned to `@artist`, and `duration` (the length of the song in seconds) is assigned to `@duration`.

Let's test our spiffy new class.

```
song = Song.new("Bicylops", "Fleck", 260)
song.inspect → #<Song:0x1c7ca8 @name="Bicylops", @duration=260,
               @artist="Fleck">
```

Well, it seems to work. By default, the `inspect` message, which can be sent to any object, formats the object's ID and instance variables. It looks as though we have them set up correctly.

Our experience tells us that during development we'll be printing out the contents of a `Song` object many times, and `inspect`'s default formatting leaves something to be desired. Fortunately, Ruby has a standard message, `to_s`, that it sends to any object it wants to render as a string. Let's try it on our song.

```
song = Song.new("Bicylops", "Fleck", 260)
song.to_s → "#<Song:0x1c7ec4>"
```

That wasn't too useful—it just reported the object ID. So, let's override `to_s` in our class. As we do this, we should also take a moment to talk about how we're showing the class definitions in this book.

In Ruby, classes are never closed: you can always add methods to an existing class. This applies to the classes you write as well as the standard, built-in classes. Just open a class definition for an existing class, and the new contents you specify will be added to whatever's there.

This is great for our purposes. As we go through this chapter, adding features to our classes, we'll show just the class definitions for the new methods; the old ones will still be there. It saves us having to repeat redundant stuff in each example. Obviously, though, if you were creating this code from scratch, you'd probably just throw all the methods into a single class definition.

Enough detail! Let's get back to adding a `to_s` method to our `Song` class. We'll use the `#` character in the string to interpolate the value of the three instance variables.

```
class Song
  def to_s
    "Song: #@name--#@artist ( #@duration )"
  end
end
song = Song.new("Bicylops", "Fleck", 260)
song.to_s → "Song: Bicylops--Fleck (260)"
```

Excellent, we're making progress. However, we've slipped something subtle into the mix. We said that Ruby supports `to_s` for all objects, but we didn't say how. The answer has to do with inheritance, subclassing, and how Ruby determines what method to run when you send a message to an object. This is a subject for a new section, so...

Inheritance and Messages

Inheritance allows you to create a class that is a refinement or specialization of another class. For example, our jukebox has the concept of songs, which we encapsulate in class `Song`. Then marketing comes along and tells us that we need to provide karaoke support. A karaoke song is just like any other (it doesn't have a vocal track, but that doesn't concern us). However, it also has an associated set of lyrics, along with timing information. When our jukebox plays a karaoke song, the lyrics should flow across the screen on the front of the jukebox in time with the music.

An approach to this problem is to define a new class, `KaraokeSong`, that is just like `Song` but with a lyric track.

```
class KaraokeSong < Song
  def initialize(name, artist, duration, lyrics)
    super(name, artist, duration)
    @lyrics = lyrics
  end
end
```

The "`< Song`" on the class definition line tells Ruby that a `KaraokeSong` is a *subclass* of `Song`. (Not surprisingly, this means that `Song` is a *superclass* of `KaraokeSong`. People also talk about parent-child relationships, so `KaraokeSong`'s parent would be `Song`.) For now, don't worry too much about the `initialize` method; we'll talk about that `super` call later.

Let's create a `KaraokeSong` and check that our code worked. (In the final system, the lyrics will be held in an object that includes the text and timing information.) To test our class, though, we'll just use a string. This is another benefit of dynamically typed languages—we don't have to define everything before we start running code.

```
song = KaraokeSong.new("My Way", "Sinatra", 225, "And now, the...")
song.to_s → "Song: My Way--Sinatra (225)"
```

Well, it ran. But why doesn't the `to_s` method show the lyric?

The answer has to do with the way Ruby determines which method should be called when you send a message to an object. During the initial parsing of the program source, when Ruby comes across the method invocation `song.to_s`, it doesn't actually know where to find the method `to_s`. Instead, it defers the decision until the program is run. At that time, it looks at the class of `song`. If that class implements a method with the same name as the message, that method is run. Otherwise, Ruby looks for a method in the parent class, and then in the grandparent, and so on up the ancestor chain. If it runs out of ancestors without finding the appropriate method, it takes a special action that normally results in an error being raised.²

Back to our example. We sent the message `to_s` to `song`, an object of class `KaraokeSong`. Ruby looks in `KaraokeSong` for a method called `to_s` but doesn't find it. The interpreter then looks in `KaraokeSong`'s parent, class `Song`, and there it finds the `to_s` method that we defined on page 24. That's why it prints out the song details but not the lyrics—class `Song` doesn't know anything about lyrics.

Let's fix this by implementing `KaraokeSong#to_s`. You have a number of ways to do this. Let's start with a bad way. We'll copy the `to_s` method from `Song` and add on the lyric.

```
class KaraokeSong
  # ...
  def to_s
    "KS: #@name--#@artist (#@duration) [#{@lyrics}]"
  end
end
song = KaraokeSong.new("My Way", "Sinatra", 225, "And now, the...")
song.to_s → "KS: My Way--Sinatra (225) [And now, the...]"
```

We're correctly displaying the value of the `@lyrics` instance variable. To do this, the subclass directly accesses the instance variables of its ancestors. So why is this a bad way to implement `to_s`?

The answer has to do with good programming style (and something called *decoupling*). By poking around inside our parent's internal structure, and explicitly examining its instance variables, we're tying ourselves tightly to its implementation. Say we decided to change `Song` to store the duration in milliseconds. Suddenly, `KaraokeSong` would start reporting ridiculous values. The idea of a karaoke version of "My Way" that lasts for 3,750 minutes is just too frightening to consider.

2. In fact, you can intercept this error, which allows you to fake out methods at runtime. This is described under `Object#method_missing` on page 551.

We get around this problem by having each class handle its own implementation details. When `KaraokeSong#to_s` is called, we'll have it call its parent's `to_s` method to get the song details. It will then append to this the lyric information and return the result. The trick here is the Ruby keyword `super`. When you invoke `super` with no arguments, Ruby sends a message to the parent of the current object, asking it to invoke a method of the same name as the method invoking `super`. It passes this method the parameters that were passed to the originally invoked method. Now we can implement our new and improved `to_s`.

```
class KaraokeSong < Song
  # Format ourselves as a string by appending
  # our lyrics to our parent's #to_s value.
  def to_s
    super + " [#@lyrics]"
  end
end
song = KaraokeSong.new("My Way", "Sinatra", 225, "And now, the...")
song.to_s → "Song: My Way--Sinatra (225) [And now, the...]"
```

We explicitly told Ruby that `KaraokeSong` was a subclass of `Song`, but we didn't specify a parent class for `Song` itself. If you don't specify a parent when defining a class, Ruby supplies class `Object` as a default. This means that all objects have `Object` as an ancestor and that `Object`'s instance methods are available to every object in Ruby. Back on page 24 we said that `to_s` is available to all objects. Now we know why; `to_s` is one of more than 35 instance methods in class `Object`. The complete list begins on page 546.

So far in this chapter we've been looking at classes and their methods. Now it's time to move on to the objects, such as the instances of class `Song`.

Objects and Attributes

The `Song` objects we've created so far have an internal state (such as the song title and artist). That state is private to those objects—no other object can access an object's instance variables. In general, this is a Good Thing. It means that the object is solely responsible for maintaining its own consistency.

However, an object that is totally secretive is pretty useless—you can create it, but then you can't do anything with it. You'll normally define methods that let you access and manipulate the state of an object, allowing the outside world to interact with the object. These externally visible facets of an object are called its *attributes*.

For our `Song` objects, the first thing we may need is the ability to find out the title and artist (so we can display them while the song is playing) and the duration (so we can display some kind of progress bar).

Inheritance and Mixins

Some object-oriented languages (such as C++) support multiple inheritance, where a class can have more than one immediate parent, inheriting functionality from each. Although powerful, this technique can be dangerous, as the inheritance hierarchy can become ambiguous.

Other languages, such as Java and C#, support single inheritance. Here, a class can have only one immediate parent. Although cleaner (and easier to implement), single inheritance also has drawbacks—in the real world objects often inherit attributes from multiple sources (a ball is both a *bouncing thing* and a *spherical thing*, for example).

Ruby offers an interesting and powerful compromise, giving you the simplicity of single inheritance and the power of multiple inheritance. A Ruby class has only one direct parent, so Ruby is a single-inheritance language. However, Ruby classes can include the functionality of any number of *mixins* (a mixin is like a partial class definition). This provides a controlled multiple-inheritance-like capability with none of the drawbacks. We'll explore mixins more beginning on page 111.

```
class Song
  def name
    @name
  end
  def artist
    @artist
  end
  def duration
    @duration
  end
end
song = Song.new("Bicylops", "Fleck", 260)
song.artist    → "Fleck"
song.name      → "Bicylops"
song.duration  → 260
```

Here we've defined three accessor methods to return the values of the three instance variables. The method `name()`, for example, returns the value of the instance variable `@name`. Because this is such a common idiom, Ruby provides a convenient shortcut: `attr_reader` creates these accessor methods for you.

```
class Song
  attr_reader :name, :artist, :duration
end
```



```

song = Song.new("Bicylops", "Fleck", 260)
song.artist   → "Fleck"
song.name     → "Bicylops"
song.duration → 260

```

This example has introduced something new. The construct `:artist` is an expression that returns a `Symbol` object corresponding to `artist`. You can think of `:artist` as meaning the *name* of the variable `artist`, and plain `artist` as meaning the *value* of the variable. In this example, we named the accessor methods `name`, `artist`, and `duration`. The corresponding instance variables, `@name`, `@artist`, and `@duration`, will be created automatically. These accessor methods are identical to the ones we wrote by hand earlier.

Writable Attributes

Sometimes you need to be able to set an attribute from outside the object. For example, let's assume that the duration that is initially associated with a song is an estimate (perhaps gathered from information on a CD or in the MP3 data). The first time we play the song, we get to find out how long it actually is, and we store this new value back in the `Song` object.

In languages such as C++ and Java, you'd do this with *setter functions*.

```

class JavaSong {                               // Java code
  private Duration _duration;
  public void setDuration(Duration newDuration) {
    _duration = newDuration;
  }
}
s = new Song(...);
s.setDuration(length);

```

In Ruby, the attributes of an object can be accessed as if they were any other variable. We've seen this above with phrases such as `song.name`. So, it seems natural to be able to assign to these variables when you want to set the value of an attribute. In Ruby you do that by creating a method whose name ends with an equals sign. These methods can be used as the target of assignments.

```

class Song
  def duration=(new_duration)
    @duration = new_duration
  end
end
song = Song.new("Bicylops", "Fleck", 260)
song.duration → 260
song.duration = 257 # set attribute with updated value
song.duration → 257

```

The assignment `song.duration = 257` invokes the method `duration=` in the `song` object, passing it 257 as an argument. In fact, defining a method name ending in an equals sign makes that name eligible to appear on the left side of an assignment.

Again, Ruby provides a shortcut for creating these simple attribute-setting methods.

```
class Song
  attr_writer :duration
end
song = Song.new("Bicylops", "Fleck", 260)
song.duration = 257
```

Virtual Attributes

These attribute-accessing methods do not have to be just simple wrappers around an object's instance variables. For example, you may want to access the duration in minutes and fractions of a minute, rather than in seconds as we've been doing.

```
class Song
  def duration_in_minutes
    @duration/60.0 # force floating point
  end
  def duration_in_minutes=(new_duration)
    @duration = (new_duration*60).to_i
  end
end
song = Song.new("Bicylops", "Fleck", 260)
song.duration_in_minutes → 4.333333333333333
song.duration_in_minutes = 4.2
song.duration → 252
```

Here we've used attribute methods to create a virtual instance variable. To the outside world, `duration_in_minutes` seems to be an attribute like any other. Internally, though, it has no corresponding instance variable.

This is more than a curiosity. In his landmark book *Object-Oriented Software Construction* [Mey97], Bertrand Meyer calls this the *Uniform Access Principle*. By hiding the difference between instance variables and calculated values, you are shielding the rest of the world from the implementation of your class. You're free to change how things work in the future without impacting the millions of lines of code that use your class. This is a big win.

Attributes, Instance Variables, and Methods

This description of attributes may leave you thinking that they're nothing more than methods—why'd we need to invent a fancy name for them? In a way, that's absolutely right. An attribute *is* just a method. Sometimes an attribute simply returns the value of an instance variable. Sometimes an attribute returns the result of a calculation. And

sometimes those funky methods with equals signs at the end of their names are used to update the state of an object. So the question is, where do attributes stop and regular methods begin? What makes something an attribute, and not just a plain old method? Ultimately, that’s one of those “angels on a pinhead” questions. Here’s a personal take.

When you design a class, you decide what internal state it has and also decide how that state is to appear on the outside (to users of your class). The internal state is held in instance variables. The external state is exposed through methods we’re calling *attributes*. And the other actions your class can perform are just regular methods. It really isn’t a crucially important distinction, but by calling the external state of an object its *attributes*, you’re helping clue people in to how they should view the class you’ve written.

Class Variables and Class Methods

So far, all the classes we’ve created have contained instance variables and instance methods: variables that are associated with a particular instance of the class, and methods that work on those variables. Sometimes classes themselves need to have their own states. This is where class variables come in.

Class Variables

A class variable is shared among all objects of a class, and it is also accessible to the class methods that we’ll describe later. Only one copy of a particular class variable exists for a given class. Class variable names start with two “at” signs, such as @@count. Unlike global and instance variables, class variables must be initialized before they are used. Often this initialization is just a simple assignment in the body of the class definition.

For example, our jukebox may want to record how many times each song has been played. This count would probably be an instance variable of the Song object. When a song is played, the value in the instance is incremented. But say we also want to know how many songs have been played in total. We could do this by searching for all the Song objects and adding their counts, or we could risk excommunication from the Church of Good Design and use a global variable. Instead, we’ll use a class variable.

```
class Song
  @@plays = 0
  def initialize(name, artist, duration)
    @name      = name
    @artist    = artist
    @duration  = duration
    @plays     = 0
  end
```

```

def play
  @plays += 1 # same as @plays = @plays + 1
  @@plays += 1
  "This song: #{@plays} plays. Total #{@@plays} plays."
end
end

```

For debugging purposes, we've arranged for `Song#play` to return a string containing the number of times this song has been played, along with the total number of plays for all songs. We can test this easily.

```

s1 = Song.new("Song1", "Artist1", 234) # test songs..
s2 = Song.new("Song2", "Artist2", 345)
s1.play → "This song: 1 plays. Total 1 plays."
s2.play → "This song: 1 plays. Total 2 plays."
s1.play → "This song: 2 plays. Total 3 plays."
s1.play → "This song: 3 plays. Total 4 plays."

```

Class variables are private to a class and its instances. If you want to make them accessible to the outside world, you'll need to write an accessor method. This method could be either an instance method or, leading us neatly to the next section, a class method.

Class Methods

Sometimes a class needs to provide methods that work without being tied to any particular object. We've already come across one such method. The new method creates a new `Song` object but is not itself associated with a particular song.

```

song = Song.new(...)

```

You'll find class methods sprinkled throughout the Ruby libraries. For example, objects of class `File` represent open files in the underlying file system. However, class `File` also provides several class methods for manipulating files that aren't open and therefore don't have a `File` object. If you want to delete a file, you call the class method `File.delete`, passing in the name.

```

File.delete("doomed.txt")

```

Class methods are distinguished from instance methods by their definition; class methods are defined by placing the class name and a period in front of the method name (but also see the sidebar on page 34).

```

class Example
  def instance_method      # instance method
  end
  def Example.class_method # class method
  end
end

```

Jukeboxes charge money for each song played, not by the minute. That makes short songs more profitable than long ones. We may want to prevent songs that take too long from being available on the `SongList`. We could define a class method in `SongList` that checked to see if a particular song exceeded the limit. We'll set this limit using a class constant, which is simply a constant (remember constants? They start with an uppercase letter) that is initialized in the class body.

```
class SongList
  MAX_TIME = 5*60          # 5 minutes

  def SongList.is_too_long(song)
    return song.duration > MAX_TIME
  end
end
song1 = Song.new("Bicylops", "Fleck", 260)
SongList.is_too_long(song1) → false
song2 = Song.new("The Calling", "Santana", 468)
SongList.is_too_long(song2) → true
```

Singletons and Other Constructors

Sometimes you want to override the default way in which Ruby creates objects. As an example, let's look at our jukebox. Because we'll have many jukeboxes, spread all over the country, we want to make maintenance as easy as possible. Part of the requirement is to log everything that happens to a jukebox: the songs played, the money received, the strange fluids poured into it, and so on. Because we want to reserve the network bandwidth for music, we'll store these log files locally. This means we'll need a class that handles logging. However, we want only one logging object per jukebox, and we want that object to be shared among all the other objects that use it.

Enter the Singleton pattern, documented in *Design Patterns* [GHJV95]. We'll arrange things so that the only way to create a logging object is to call `MyLogger.create`, and we'll ensure that only one logging object is ever created.

```
class MyLogger
  private_class_method :new
  @@logger = nil
  def MyLogger.create
    @@logger = new unless @@logger
    @@logger
  end
end
```

By making `MyLogger`'s `new` method private, we prevent anyone from creating a logging object using the conventional constructor. Instead, we provide a class method, `MyLogger.create`. This method uses the class variable `@@logger` to keep a reference

Class Method Definitions

Back on page 32 we said that class methods are defined by putting the class name and a period in front of the method name. That was actually a simplification (but one that works all the time).

In fact, you can define class methods in a number of ways, but understanding *why* those ways work will have to wait until Chapter 24. For now, we'll just show you the idioms that people use, in case you come across them in Ruby code.

The following all define class methods within class `Demo`.

```
class Demo
  def Demo.meth1
    # ...
  end
  def self.meth2
    # ...
  end
  class <<self
    def meth3
      # ...
    end
  end
end
```

to a single instance of the logger, returning that instance every time it is called.³ We can check this by looking at the object identifiers the method returns.

```
MyLogger.create.id → 936550
MyLogger.create.id → 936550
```

Using class methods as pseudo-constructors can also make life easier for users of your class. As a trivial example, let's look at a class `Shape` that represents a regular polygon. Instances of `Shape` are created by giving the constructor the required number of sides and the total perimeter.

```
class Shape
  def initialize(num_sides, perimeter)
    # ...
  end
end
```

3. The implementation of singletons that we present here is not thread-safe; if multiple threads were running, it would be possible to create multiple logger objects. Rather than add thread safety ourselves, however, we'd probably use the `Singleton` mixin supplied with Ruby, which is described on page 712.

However, a couple of years later, this class is used in a different application, where the programmers are used to creating shapes by name and by specifying the length of one side, not the perimeter. Simply add some class methods to Shape.

```
class Shape
  def Shape.triangle(side_length)
    Shape.new(3, side_length*3)
  end
  def Shape.square(side_length)
    Shape.new(4, side_length*4)
  end
end
```

Class methods have many interesting and powerful uses, but exploring them won't get our jukebox finished any sooner, so let's move on.

Access Control

When designing a class interface, it's important to consider just how much access to your class you'll be exposing to the outside world. Allow too much access into your class, and you risk increasing the coupling in your application—users of your class will be tempted to rely on details of your class's implementation, rather than on its logical interface. The good news is that the only easy way to change an object's state in Ruby is by calling one of its methods. Control access to the methods, and you've controlled access to the object. A good rule of thumb is never to expose methods that could leave an object in an invalid state. Ruby gives you three levels of protection.

- **Public methods** can be called by anyone—no access control is enforced. Methods are public by default (except for `initialize`, which is always private).
- **Protected methods** can be invoked only by objects of the defining class and its subclasses. Access is kept within the family.
- **Private methods** cannot be called with an explicit receiver—the receiver is always *self*. This means that private methods can be called only in the context of the current object; you can't invoke another object's private methods.

The difference between “protected” and “private” is fairly subtle and is different in Ruby than in most common OO languages. If a method is protected, it may be called by *any* instance of the defining class or its subclasses. If a method is private, it may be called only within the context of the calling object—it is never possible to access another object's private methods directly, even if the object is of the same class as the caller.

Ruby differs from other OO languages in another important way. Access control is determined dynamically, as the program runs, not statically. You will get an access violation only when the code attempts to execute the restricted method.

Specifying Access Control

You specify access levels to methods within class or module definitions using one or more of the three functions `public`, `protected`, and `private`. You can use each function in two different ways.

If used with no arguments, the three functions set the default access control of subsequently defined methods. This is probably familiar behavior if you're a C++ or Java programmer, where you'd use keywords such as `public` to achieve the same effect.

```
class MyClass
  def method1    # default is 'public'
    #...
  end

  protected     # subsequent methods will be 'protected'
  def method2    # will be 'protected'
    #...
  end

  private       # subsequent methods will be 'private'
  def method3    # will be 'private'
    #...
  end

  public        # subsequent methods will be 'public'
  def method4    # and this will be 'public'
    #...
  end
end
```

Alternatively, you can set access levels of named methods by listing them as arguments to the access control functions.

```
class MyClass
  def method1
  end
  # ... and so on
  public   :method1, :method4
  protected :method2
  private  :method3
end
```

It's time for some examples. Perhaps we're modeling an accounting system where every debit has a corresponding credit. Because we want to ensure that no one can break this rule, we'll make the methods that do the debits and credits private, and we'll define our external interface in terms of transactions.

```

class Accounts
  def initialize(checking, savings)
    @checking = checking
    @savings = savings
  end
  private
  def debit(account, amount)
    account.balance -= amount
  end
  def credit(account, amount)
    account.balance += amount
  end
  public
  #...
  def transfer_to_savings(amount)
    debit(@checking, amount)
    credit(@savings, amount)
  end
  #...
end

```

Protected access is used when objects need to access the internal state of other objects of the same class. For example, we may want to allow individual Account objects to compare their raw balances but may want to hide those balances from the rest of the world (perhaps because we present them in a different form).

```

class Account
  attr_reader :balance      # accessor method 'balance'
  protected :balance       # and make it protected
  def greater_balance_than(other)
    return @balance > other.balance
  end
end

```

Because the attribute `balance` is protected, it's available only within Account objects.

Variables

Now that we've gone to the trouble to create all these objects, let's make sure we don't lose them. Variables are used to keep track of objects; each variable holds a reference to an object.

Let's confirm this with some code.

```

person = "Tim"
person.id    → 936870
person.class → String
person      → "Tim"

```

On the first line, Ruby creates a new `String` object with the value “Tim.” A reference to this object is placed in the local variable `person`. A quick check shows that the variable has indeed taken on the personality of a string, with an object ID, a class, and a value.

So, is a variable an object? In Ruby, the answer is “no.” A variable is simply a reference to an object. Objects float around in a big pool somewhere (the heap, most of the time) and are pointed to by variables.

Let’s make the example slightly more complicated.

```
person1 = "Tim"
person2 = person1

person1[0] = 'J'

person1 → "Jim"
person2 → "Jim"
```

What happened here? We changed the first character of `person1`, but both `person1` and `person2` changed from “Tim” to “Jim.”

It all comes back to the fact that variables hold references to objects, not the objects themselves. The assignment of `person1` to `person2` doesn’t create any new objects; it simply copies `person1`’s object reference to `person2` so that both `person1` and `person2` refer to the same object. We show this in Figure 3.1 on the following page.

Assignment *aliases* objects, potentially giving you multiple variables that reference the same object. But can’t this cause problems in your code? It can, but not as often as you’d think (objects in Java, for example, work exactly the same way). For instance, in the example in Figure 3.1, you could avoid aliasing by using the `dup` method of `String`, which creates a new `String` object with identical contents.

```
person1 = "Tim"
person2 = person1.dup
person1[0] = "J"
person1 → "Jim"
person2 → "Tim"
```

You can also prevent anyone from changing a particular object by freezing it (we talk more about freezing objects on page 377). Attempt to alter a frozen object, and Ruby will raise a `TypeError` exception.

```
person1 = "Tim"
person2 = person1
person1.freeze # prevent modifications to the object
person2[0] = "J"
```

produces:

```
prog.rb:4:in `[]=: can't modify frozen string (TypeError)
from prog.rb:4
```

Figure 3.1. Variables hold object references.

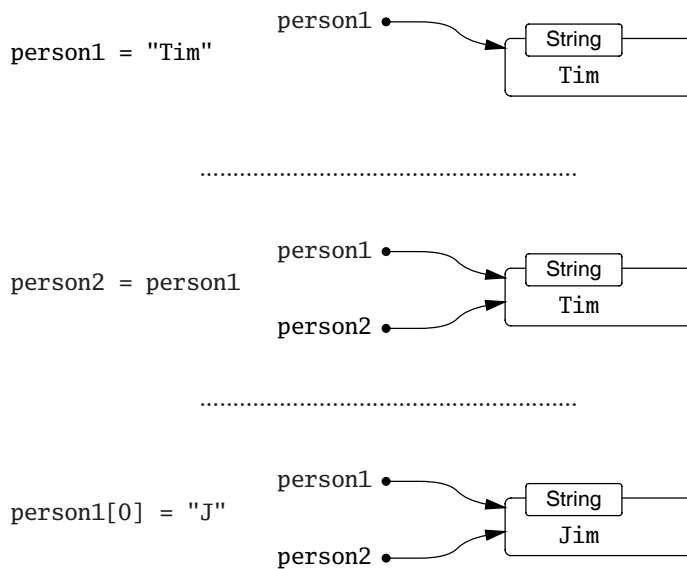

That concludes our look at classes and objects in Ruby. This material is important; everything you manipulate in Ruby is an object. And one of the most common things we do with objects is create collections of them. But that's the subject of our next chapter.

Containers, Blocks, and Iterators

A jukebox with one song is unlikely to be popular (except perhaps in some very, very scary bars), so pretty soon we'll have to start thinking about producing a catalog of available songs and a playlist of songs waiting to be played. Both of these are *containers*: objects that hold references to one or more other objects.

Both the catalog and the playlist need a similar set of methods: add a song, remove a song, return a list of songs, and so on. The playlist may perform additional tasks, such as inserting advertising every so often or keeping track of cumulative play time, but we'll worry about these things later. In the meantime, it seems like a good idea to develop some kind of generic `SongList` class, which we can specialize into catalogs and playlists.

Containers

Before we start implementing, we'll need to work out how to store the list of songs inside a `SongList` object. We have three obvious choices. We could use the Ruby `Array` type, use the Ruby `Hash` type, or create our own list structure. Being lazy, for now we'll look at arrays and hashes and choose one of these for our class.

Arrays

The class `Array` holds a collection of object references. Each object reference occupies a position in the array, identified by a non-negative integer index.

You can create arrays by using literals or by explicitly creating an `Array` object. A literal array is simply a list of objects between square brackets.

```

a = [ 3.14159, "pie", 99 ]
a.class   → Array
a.length  → 3
a[0]      → 3.14159
a[1]      → "pie"
a[2]      → 99
a[3]      → nil

b = Array.new
b.class   → Array
b.length  → 0
b[0] = "second"
b[1] = "array"
b        → ["second", "array"]

```

Arrays are indexed using the `[]` operator. As with most Ruby operators, this is actually a method (an instance method of class `Array`) and hence can be overridden in subclasses. As the example shows, array indices start at zero. Index an array with a non-negative integer, and it returns the object at that position or returns `nil` if nothing is there. Index an array with a negative integer, and it counts from the end.

```

a = [ 1, 3, 5, 7, 9 ]
a[-1] → 9
a[-2] → 7
a[-99] → nil

```

This indexing scheme is illustrated in more detail in Figure 4.1 on the following page.

You can also index arrays with a pair of numbers, `[start, count]`. This returns a new array consisting of references to count objects starting at position `start`.

```

a = [ 1, 3, 5, 7, 9 ]
a[1, 3] → [3, 5, 7]
a[3, 1] → [7]
a[-3, 2] → [5, 7]

```

Finally, you can index arrays using ranges, in which start and end positions are separated by two or three periods. The two-period form includes the end position, and the three-period form does not.

```

a = [ 1, 3, 5, 7, 9 ]
a[1..3] → [3, 5, 7]
a[1...3] → [3, 5]
a[3..3] → [7]
a[-3..-1] → [5, 7, 9]

```

The `[]` operator has a corresponding `[]=` operator, which lets you set elements in the array. If used with a single integer index, the element at that position is replaced by whatever is on the right side of the assignment. Any gaps that result will be filled with `nil`.

Figure 4.1. How arrays are indexed

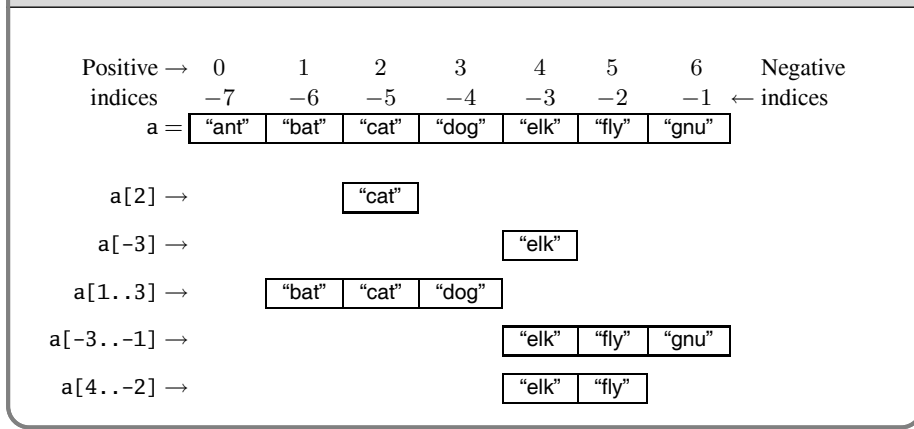

```

a = [ 1, 3, 5, 7, 9 ] → [1, 3, 5, 7, 9]
a[1] = 'bat' → [1, "bat", 5, 7, 9]
a[-3] = 'cat' → [1, "bat", "cat", 7, 9]
a[3] = [ 9, 8 ] → [1, "bat", "cat", [9, 8], 9]
a[6] = 99 → [1, "bat", "cat", [9, 8], 9, nil, 99]

```

If the index to `[]` is two numbers (a start and a length) or a range, then those elements in the original array are replaced by whatever is on the right side of the assignment. If the length is zero, the right side is inserted into the array before the start position; no elements are removed. If the right side is itself an array, its elements are used in the replacement. The array size is automatically adjusted if the index selects a different number of elements than are available on the right side of the assignment.

```

a = [ 1, 3, 5, 7, 9 ] → [1, 3, 5, 7, 9]
a[2, 2] = 'cat' → [1, 3, "cat", 9]
a[2, 0] = 'dog' → [1, 3, "dog", "cat", 9]
a[1, 1] = [ 9, 8, 7 ] → [1, 9, 8, 7, "dog", "cat", 9]
a[0..3] = [] → ["dog", "cat", 9]
a[5..6] = 99, 98 → ["dog", "cat", 9, nil, nil, 99, 98]

```

Arrays have a large number of other useful methods. Using these, you can treat arrays as stacks, sets, queues, dequeues, and fifos. A complete list of array methods starts on page [406](#).

Hashes

Hashes (sometimes known as *associative arrays*, *maps*, or *dictionaries*) are similar to arrays in that they are indexed collections of object references. However, while you index arrays with integers, you can index a hash with objects of any type: strings, regular expressions, and so on. When you store a value in a hash, you actually supply

two objects—the index, normally called the *key*, and the value. You can subsequently retrieve the value by indexing the hash with the same key. The values in a hash can be objects of any type.

The example that follows uses hash literals: a list of *key => value* pairs between braces.

```
h = { 'dog' => 'canine', 'cat' => 'feline', 'donkey' => 'asinine' }

h.length → 3
h['dog'] → "canine"
h['cow'] = 'bovine'
h[12]    = 'dodecine'
h['cat'] = 99
h        → {"cow"=>"bovine", "cat"=>99, 12=>"dodecine",
           "donkey"=>"asinine", "dog"=>"canine"}
```

Compared with arrays, hashes have one significant advantage: they can use any object as an index. However, they also have a significant disadvantage: their elements are not ordered, so you cannot easily use a hash as a stack or a queue.

You'll find that hashes are one of the most commonly used data structures in Ruby. A full list of the methods implemented by class Hash starts on page [471](#).

Implementing a SongList Container

After that little diversion into arrays and hashes, we're now ready to implement the jukebox's SongList. Let's invent a basic list of methods we need in our SongList. We'll want to add to it as we go along, but this will do for now.

`append(song)` → list

Append the given song to the list.

`delete_first()` → song

Remove the first song from the list, returning that song.

`delete_last()` → song

Remove the last song from the list, returning that song.

`[index]` → song

Return the song at the integer *index*.

`with_title(title)` → song

Return the song with the given title.

This list gives us a clue to the implementation. The ability to append songs at the end, and remove them from both the front and end, suggests a *dequeue*—a double-ended queue—which we know we can implement using an Array. Similarly, the ability to return a song at an integer position in the list is supported by arrays.

However, you also need to be able to retrieve songs by title, which may suggest using a hash, with the title as a key and the song as a value. Could we use a hash? Well, possibly, but this causes problems. First, a hash is unordered, so we'd probably need to use an ancillary array to keep track of the list. A second, bigger problem is that a hash does not support multiple keys with the same value. That would be a problem for our playlist, where the same song may be queued for playing multiple times. So, for now we'll stick with an array of songs, searching it for titles when needed. If this becomes a performance bottleneck, we can always add some kind of hash-based lookup later.

We'll start our class with a basic `initialize` method, which creates the `Array` we'll use to hold the songs and stores a reference to it in the instance variable `@songs`.

```
class SongList
  def initialize
    @songs = Array.new
  end
end
```

The `SongList#append` method adds the given song to the end of the `@songs` array. It also returns *self*, a reference to the current `SongList` object. This is a useful convention, as it lets us chain together multiple calls to `append`. We'll see an example of this later.

```
class SongList
  def append(song)
    @songs.push(song)
    self
  end
end
```

Then we'll add the `delete_first` and `delete_last` methods, trivially implemented using `Array#shift` and `Array#pop`, respectively.

```
class SongList
  def delete_first
    @songs.shift
  end
  def delete_last
    @songs.pop
  end
end
```

So far, so good. Our next method is `[]`, which accesses elements by index. These kind of simple delegating methods occur frequently in Ruby code: don't worry if your code ends up containing a bunch of one- or two-line methods—it's a sign that you're designing things correctly.

```
class SongList
  def [](index)
    @songs[index]
  end
end
```

At this point, a quick test may be in order. To do this, we're going to use a testing framework called TestUnit that comes with the standard Ruby distributions. We won't describe it fully yet (we do that in the *Unit Testing* chapter starting on page 143). For now, we'll just say that the method `assert_equal` checks that its two parameters are equal, complaining bitterly if they aren't. Similarly, the method `assert_nil` complains unless its parameter is `nil`. We're using these assertions to verify that the correct songs are deleted from the list.

The test contains some initial housekeeping, necessary to tell Ruby to use the TestUnit framework and to tell the framework that we're writing some test code. Then we create a `SongList` and four songs and append the songs to the list. (Just to show off, we use the fact that `append` returns the `SongList` object to chain together these method calls.) We can then test our `[]` method, verifying that it returns the correct song (or `nil`) for a set of indices. Finally, we delete songs from the start and end of the list, checking that the correct songs are returned.

```
require 'test/unit'
class TestSongList < Test::Unit::TestCase
  def test_delete
    list = SongList.new
    s1 = Song.new('title1', 'artist1', 1)
    s2 = Song.new('title2', 'artist2', 2)
    s3 = Song.new('title3', 'artist3', 3)
    s4 = Song.new('title4', 'artist4', 4)

    list.append(s1).append(s2).append(s3).append(s4)
    assert_equal(s1, list[0])
    assert_equal(s3, list[2])
    assert_nil(list[9])

    assert_equal(s1, list.delete_first)
    assert_equal(s2, list.delete_first)
    assert_equal(s4, list.delete_last)
    assert_equal(s3, list.delete_last)
    assert_nil(list.delete_last)
  end
end
```

produces:

```
Loaded suite -
Started
.
Finished in 0.002314 seconds.
```

```
1 tests, 8 assertions, 0 failures, 0 errors
```

The running test confirms that eight assertions were executed in one test method, and they all passed. We're on our way to a working jukebox!

Now we need to add the facility that lets us look up a song by title. This is going to involve scanning through the songs in the list, checking the title of each. To do this, we first need to spend a couple of pages looking at one of Ruby’s neatest features: iterators.

Blocks and Iterators

Our next problem with `SongList` is to implement the method `with_title` that takes a string and searches for a song with that title. This seems straightforward: we have an array of songs, so we’ll go through it one element at a time, looking for a match.

```
class SongList
  def with_title(title)
    for i in 0..@songs.length
      return @songs[i] if title == @songs[i].name
    end
    return nil
  end
end
```

This works, and it looks comfortingly familiar: a `for` loop iterating over an array. What could be more natural?

It turns out there *is* something more natural. In a way, our `for` loop is somewhat too intimate with the array; it asks for a length, and it then retrieves values in turn until it finds a match. Why not just ask the array to apply a test to each of its members? That’s just what the `find` method in `Array` does.

```
class SongList
  def with_title(title)
    @songs.find {|song| title == song.name }
  end
end
```

The method `find` is an *iterator*—a method that invokes a block of code repeatedly. Iterators and code blocks are among the more interesting features of Ruby, so let’s spend a while looking into them (and in the process we’ll find out exactly what that line of code in our `with_title` method actually does).

Implementing Iterators

A Ruby iterator is simply a method that can invoke a block of code. At first sight, a block in Ruby looks just like a block in C, Java, C#, or Perl. Unfortunately, in this case looks are deceiving—a Ruby block *is* a way of grouping statements, but not in the conventional way.

First, a block may appear only in the source adjacent to a method call; the block is written starting on the same line as the method call’s last parameter (or the closing

parenthesis of the parameter list). Second, the code in the block is not executed at the time it is encountered. Instead, Ruby remembers the context in which the block appears (the local variables, the current object, and so on) and then enters the method. This is where the magic starts.

Within the method, the block may be invoked, almost as if it were a method itself, using the `yield` statement. Whenever a `yield` is executed, it invokes the code in the block. When the block exits, control picks back up immediately after the `yield`.¹ Let's start with a trivial example.

```
def three_times
  yield
  yield
  yield
end
three_times { puts "Hello" }
```

produces:

```
Hello
Hello
Hello
```

The block (the code between the braces) is associated with the call to the method `three_times`. Within this method, `yield` is called three times in a row. Each time, it invokes the code in the block, and a cheery greeting is printed. What makes blocks interesting, however, is that you can pass parameters to them and receive values from them. For example, we could write a simple function that returns members of the Fibonacci series up to a certain value.²

```
def fib_up_to(max)
  i1, i2 = 1, 1      # parallel assignment (i1 = 1 and i2 = 1)
  while i1 <= max
    yield i1
    i1, i2 = i2, i1+i2
  end
end
fib_up_to(1000) {|f| print f, " " }
```

produces:

```
1 1 2 3 5 8 13 21 34 55 89 144 233 377 610 987
```

1. Programming-language buffs will be pleased to know that the keyword `yield` was chosen to echo the `yield` function in Liskov's language CLU, a language that is more than 20 years old and yet contains features that still haven't been widely exploited by the CLU-less.

2. The basic Fibonacci series is a sequence of integers, starting with two 1s, in which each subsequent term is the sum of the two preceding terms. The series is sometimes used in sorting algorithms and in analyzing natural phenomena.

In this example, the `yield` statement has a parameter. This value is passed to the associated block. In the definition of the block, the argument list appears between vertical bars. In this instance, the variable `f` receives the value passed to the `yield`, so the block prints successive members of the series. (This example also shows parallel assignment in action. We'll come back to this on page 85.) Although it is common to pass just one value to a block, this is not a requirement; a block may have any number of arguments.

If the parameters to a block are existing local variables, those variables will be used as the block parameters, and their values may be changed by the block's execution. The same thing applies to variables inside the block: if they appear for the first time in the block, they're local to the block. If instead they first appeared outside the block, the variables will be shared between the block and the surrounding environment.³

In this (contrived) example, we see that the block inherits the variables `a` and `b` from the surrounding scope, but `c` is local to the block (the method `defined?` returns `nil` if its argument is not defined).

```
a = [1, 2]
b = 'cat'
a.each {|b| c = b * a[1] }
a          → [1, 2]
b          → 2
defined?(c) → nil
```

A block may also return a value to the method. The value of the last expression evaluated in the block is passed back to the method as the value of the `yield`. This is how the `find` method used by class `Array` works.⁴ Its implementation would look something like the following.

```
class Array
  def find
    for i in 0...size
      value = self[i]
      return value if yield(value)
    end
    return nil
  end
end

[1, 3, 5, 7, 9].find {|v| v*v > 30 } → 7
```

This passes successive elements of the array to the associated block. If the block returns `true`, the method returns the corresponding element. If no element matches, the method returns `nil`. The example shows the benefit of this approach to iterators. The `Array`

3. Although extremely useful at times, this feature may lead to unexpected behavior and is hotly debated in the Ruby community. It is possible that Ruby 2.0 will change the way blocks inherit local variables.

4. The `find` method is actually defined in module `Enumerable`, which is mixed into class `Array`.

class does what it does best, accessing array elements, leaving the application code to concentrate on its particular requirement (in this case, finding an entry that meets some mathematical criteria).

Some iterators are common to many types of Ruby collections. We've looked at `find` already. Two others are `each` and `collect`. `each` is probably the simplest iterator—all it does is yield successive elements of its collection.

```
[ 1, 3, 5, 7, 9 ].each { |i| puts i }
```

produces:

```
1
3
5
7
9
```

The `each` iterator has a special place in Ruby; on page 97 we'll describe how it's used as the basis of the language's `for` loop, and starting on page 113 we'll see how defining an `each` method can add a whole lot more functionality to your class for free.

Another common iterator is `collect`, which takes each element from the collection and passes it to the block. The results returned by the block are used to construct a new array. For instance:

```
["H", "A", "L"].collect { |x| x.succ } → ["I", "B", "M"]
```

Iterators are not limited to accessing existing data in arrays and hashes. As we saw in the Fibonacci example, an iterator can return derived values. This capability is used by Ruby input/output classes, which implement an iterator interface that returns successive lines (or bytes) in an I/O stream. (This example uses `do...end` to define a block. The only difference between this notation and using braces to define blocks is precedence: `do...end` binds lower than `{...}`. We discuss the impact of this on page 341.)

```
f = File.open("testfile")
f.each do |line|
  puts line
end
f.close
```

produces:

```
This is line one
This is line two
This is line three
And so on...
```

1.8

Let's look at just one more useful iterator. The (somewhat obscurely named) `inject` method (defined in the module `Enumerable`) lets you accumulate a value across the

members of a collection. For example, you can sum all the elements in an array, and find their product, using code such as

```
[1,3,5,7].inject(0) {|sum, element| sum+element} → 16
[1,3,5,7].inject(1) {|product, element| product*element} → 105
```

`inject` works like this: the first time the associated block is called, `sum` is set to `inject`'s parameter and `element` is set to the first element in the collection. The second and subsequent times the block is called, `sum` is set to the value returned by the block on the previous call. The final value of `inject` is the value returned by the block the last time it was called. There's one final wrinkle: if `inject` is called with no parameter, it uses the first element of the collection as the initial value and starts the iteration with the second value. This means that we could have written the previous examples as

```
[1,3,5,7].inject {|sum, element| sum+element} → 16
[1,3,5,7].inject {|product, element| product*element} → 105
```

Internal and External Iterators

It's worth spending a paragraph comparing Ruby's approach to iterators to that of languages such as C++ and Java. In the Ruby approach, the iterator is internal to the collection—it's simply a method, identical to any other, that happens to call `yield` whenever it generates a new value. The thing that uses the iterator is just a block of code associated with this method.

In other languages, collections don't contain their own iterators. Instead, they generate external helper objects (for example, those based on Java's `Iterator` interface) that carry the iterator state. In this, as in many other ways, Ruby is a transparent language. When you write a Ruby program, you concentrate on getting the job done, not on building scaffolding to support the language itself.

It's probably also worth spending a paragraph looking at why Ruby's internal iterators aren't always the best solution. One area where they fall down badly is where you need to treat an iterator as an object in its own right (for example, passing the iterator into a method that needs to access each of the values returned by that iterator). It's also difficult to iterate over two collections in parallel using Ruby's internal iterator scheme. Fortunately, Ruby 1.8 comes with the Generator library (described on page 662), which implements external iterators in Ruby for just such occasions.

1.8

Blocks for Transactions

Although blocks are often the target of an iterator, they also have other uses. Let's look at a few.

You can use blocks to define a chunk of code that must be run under some kind of transactional control. For example, you'll often open a file, do something with its contents, and then want to ensure that the file is closed when you finish. Although you can do this

using conventional code, an argument exists for making the file responsible for closing itself. We can do this with blocks. A naive implementation (ignoring error handling) could look something like the following.

```
class File
  def File.open_and_process(*args)
    f = File.open(*args)
    yield f
    f.close()
  end
end

File.open_and_process("testfile", "r") do |file|
  while line = file.gets
    puts line
  end
end
```

produces:

```
This is line one
This is line two
This is line three
And so on...
```

`open_and_process` is a *class method*—it may be called independently of any particular file object. We want it to take the same arguments as the conventional `File.open` method, but we don’t really care what those arguments are. To do this, we specified the arguments as `*args`, meaning “collect the actual parameters passed to the method into an array named `args`.” We then call `File.open`, passing it `*args` as a parameter. This expands the array back into individual parameters. The net result is that `open_and_process` transparently passes whatever parameters it received to `File.open`.

Once the file has been opened, `open_and_process` calls `yield`, passing the open file object to the block. When the block returns, the file is closed. In this way, the responsibility for closing an open file has been passed from the user of file objects back to the files themselves.

The technique of having files manage their own life cycle is so useful that the class `File` supplied with Ruby supports it directly. If `File.open` has an associated block, then that block will be invoked with a file object, and the file will be closed when the block terminates. This is interesting, as it means that `File.open` has two different behaviors: when called with a block, it executes the block and closes the file. When called without a block, it returns the file object. This is made possible by the method `Kernel.block_given?`, which returns `true` if a block is associated with the current method. Using this method, you could implement something similar to the standard `File.open` (again, ignoring error handling) using the following.

```

class File
  def File.my_open(*args)
    result = file = File.new(*args)
    # If there's a block, pass in the file and close
    # the file when it returns
    if block_given?
      result = yield file
      file.close
    end
    return result
  end
end

```

This has one last twist: in the previous examples of using blocks to control resources, we haven't addressed error handling. If we wanted to implement these methods properly, we'd need to ensure that we closed files even if the code processing that file somehow aborted. We do this using exception handling, which we talk about later (starting on page 101).

Blocks Can Be Closures

Let's get back to our jukebox for a moment (remember the jukebox?). At some point we'll be working on the code that handles the user interface—the buttons that people press to select songs and control the jukebox. We'll need to associate actions with those buttons: press `START` and the music starts. It turns out that Ruby's blocks are a convenient way to do this. Let's start by assuming that the people who made the hardware implemented a Ruby extension that gives us a basic button class. (We talk about extending Ruby beginning on page 261.)

```

start_button = Button.new("Start")
pause_button = Button.new("Pause")
# ...

```

What happens when the user presses one of our buttons? In the `Button` class, the hardware folks rigged things so that a callback method, `button_pressed`, will be invoked. The obvious way of adding functionality to these buttons is to create subclasses of `Button` and have each subclass implement its own `button_pressed` method.

```

class StartButton < Button
  def initialize
    super("Start")      # invoke Button's initialize
  end
  def button_pressed
    # do start actions...
  end
end
start_button = StartButton.new

```

This has two problems. First, this will lead to a large number of subclasses. If the interface to `Button` changes, this could involve us in a lot of maintenance. Second, the actions performed when a button is pressed are expressed at the wrong level; they are not a feature of the button but are a feature of the jukebox that uses the buttons. We can fix both of these problems using blocks.

```
songlist = SongList.new
class JukeboxButton < Button
  def initialize(label, &action)
    super(label)
    @action = action
  end
  def button_pressed
    @action.call(self)
  end
end
start_button = JukeboxButton.new("Start") { songlist.start }
pause_button = JukeboxButton.new("Pause") { songlist.pause }
```

The key to all this is the second parameter to `JukeboxButton#initialize`. If the last parameter in a method definition is prefixed with an ampersand (such as `&action`), Ruby looks for a code block whenever that method is called. That code block is converted to an object of class `Proc` and assigned to the parameter. You can then treat the parameter as any other variable. In our example, we assigned it to the instance variable `@action`. When the callback method `button_pressed` is invoked, we use the `Proc#call` method on that object to invoke the block.

So what exactly do we have when we create a `Proc` object? The interesting thing is that it's more than just a chunk of code. Associated with a block (and hence a `Proc` object) is all the context in which the block was *defined*: the value of `self` and the methods, variables, and constants in scope. Part of the magic of Ruby is that the block can still use all this original scope information even if the environment in which it was defined would otherwise have disappeared. In other languages, this facility is called a *closure*.

Let's look at a contrived example. This example uses the method `lambda`, which converts a block to a `Proc` object.

```
def n_times(thing)
  return lambda {|n| thing * n }
end

p1 = n_times(23)
p1.call(3) → 69
p1.call(4) → 92
p2 = n_times("Hello ")
p2.call(3) → "Hello Hello Hello "
```

The method `n_times` returns a `Proc` object that references the method's parameter, `thing`. Even though that parameter is out of scope by the time the block is called, the parameter remains accessible to the block.

Containers Everywhere

Containers, blocks, and iterators are core concepts in Ruby. The more you write in Ruby, the more you'll find yourself moving away from conventional looping constructs. Instead, you'll write classes that support iteration over their contents. And you'll find that this code is compact, easy to read, and a joy to maintain.

Standard Types

So far we've been having fun implementing pieces of our jukebox code, but we've been negligent. We've looked at arrays, hashes, and procs, but we haven't really covered the other basic types in Ruby: numbers, strings, ranges, and regular expressions. Let's spend a few pages on these basic building blocks now.

Numbers

Ruby supports integers and floating-point numbers. Integers can be any length (up to a maximum determined by the amount of free memory on your system). Integers within a certain range (normally -2^{30} to $2^{30} - 1$ or -2^{62} to $2^{62} - 1$) are held internally in binary form and are objects of class `Fixnum`. Integers outside this range are stored in objects of class `Bignum` (currently implemented as a variable-length set of short integers). This process is transparent, and Ruby automatically manages the conversion back and forth.

```
num = 81
6.times do
  puts "#{num.class}: #{num}"
  num *= num
end
```

produces:

```
Fixnum: 81
Fixnum: 6561
Fixnum: 43046721
Bignum: 1853020188851841
Bignum: 3433683820292512484657849089281
Bignum: 11790184577738583171520872861412518665678211592275841109096961
```

You write integers using an optional leading sign, an optional base indicator (0 for octal, 0d for decimal [the default], 0x for hex, or 0b for binary), followed by a string of digits in the appropriate base. Underscore characters are ignored in the digit string (some folks use them in place of commas in larger numbers).

```

123456          => 123456 # Fixnum
0d123456        => 123456 # Fixnum
123_456         => 123456 # Fixnum - underscore ignored
-543            => -543   # Fixnum - negative number
0xaabb         => 43707  # Fixnum - hexadecimal
0377           => 255    # Fixnum - octal
-0b10_1010     => -42   # Fixnum - binary (negated)
123_456_789_123_456_789 => 123456789123456789 # Bignum

```

The integer values of control characters can be generated using `?\C-x` and `?\cx` (the control version of `x` is `x&0x9f`). Metacharacters (`x | 0x80`) can be generated using `?\M-x`. The combination of meta and control is generated using `?\M-\C-x`. You can get the integer value of a backslash character using the sequence `?\\`.

```

?a             => 97    # ASCII character
?\n           => 10    # code for a newline (0x0a)
?\C-a         => 1     # control a = ?A & 0x9f = 0x01
?\M-a        => 225   # meta sets bit 7
?\M-\C-a     => 129   # meta and control a
?\C-?        => 127   # delete character

```

1.8

A numeric literal with a decimal point and/or an exponent is turned into a `Float` object, corresponding to the native architecture's double data type. You must both precede and follow the decimal point with a digit (if you write `1.0e3` as `1.e3`, Ruby will try to invoke the method `e3` in class `Fixnum`).

All numbers are objects and respond to a variety of messages (listed in full starting on pages [420](#), [463](#), [466](#), [480](#), and [541](#)). So, unlike (say) C++, you find the absolute value of a number by writing `num.abs`, not `abs(num)`.

Integers also support several useful iterators. We've seen one already: `6.times` in the code example on the preceding page. Others include `upto` and `downto`, for iterating up and down between two integers. Class `Numeric` also provides the more general method `step`, which is more like a traditional `for` loop.

```

3.times        { print "X " }
1.upto(5)     { |i| print i, " " }
99.downto(95) { |i| print i, " " }
50.step(80, 5) { |i| print i, " " }

```

produces:

```
X X X 1 2 3 4 5 99 98 97 96 95 50 55 60 65 70 75 80
```

Finally, we'll offer a warning for Perl users. Strings that contain just digits are *not* automatically converted into numbers when used in expressions. This tends to bite most often when reading numbers from a file. For example, we may want to find the sum of the two numbers on each line for a file such as

```

3 4
5 6
7 8

```

The following code doesn't work.

```
some_file.each do |line|
  v1, v2 = line.split # split line on spaces
  print v1 + v2, " "
end
```

produces:

```
34 56 78
```

The problem is that the input was read as strings, not numbers. The plus operator concatenates strings, so that's what we see in the output. To fix this, use the `Integer` method to convert the string to an integer.

```
some_file.each do |line|
  v1, v2 = line.split
  print Integer(v1) + Integer(v2), " "
end
```

produces:

```
7 11 15
```

Strings

Ruby strings are simply sequences of 8-bit bytes. They normally hold printable characters, but that is not a requirement; a string can also hold binary data. Strings are objects of class `String`.

Strings are often created using string literals—sequences of characters between delimiters. Because binary data is otherwise difficult to represent within program source, you can place various escape sequences in a string literal. Each is replaced with the corresponding binary value as the program is compiled. The type of string delimiter determines the degree of substitution performed. Within single-quoted strings, two consecutive backslashes are replaced by a single backslash, and a backslash followed by a single quote becomes a single quote.

```
'escape using "\\\"' → escape using "\"
'That\'s right' → That's right
```

Double-quoted strings support a boatload more escape sequences. The most common is probably `\n`, the newline character. Table 22.2 on page 306 gives the complete list. In addition, you can substitute the value of any Ruby code into a string using the sequence `#{ expr }`. If the code is just a global variable, a class variable, or an instance variable, you can omit the braces.

```
"Seconds/day: #{24*60*60}" → Seconds/day: 86400
"#{'Ho! '*3}Merry Christmas!" → Ho! Ho! Ho! Merry Christmas!
"This is line #.$." → This is line 3
```

1.8 The interpolated code can be one or more statements, not just an expression.

```
puts "now is #{ def the(a)
                  'the ' + a
                end
                the('time')
              } for all good coders..."
```

produces:

```
now is the time for all good coders...
```

You have three more ways to construct string literals: %q, %Q, and *here documents*.

%q and %Q start delimited single- and double-quoted strings (you can think of %q as a thin quote ', and %Q as a thick quote ").

```
%q/general single-quoted string/ → general single-quoted string
%Q!general double-quoted string! → general double-quoted string
%Q{Seconds/day: #{24*60*60}}      → Seconds/day: 86400
```

The character following the *q* or *Q* is the delimiter. If it is an opening bracket “[”, brace “{”, parenthesis “(”, or less-than sign “<”, the string is read until the matching close symbol is found. Otherwise the string is read until the next occurrence of the same delimiter. The delimiter can be any nonalphanumeric or nonmultibyte character.

1.8

Finally, you can construct a string using a *here document*.

```
string = <<END_OF_STRING
  The body of the string
  is the input lines up to
  one ending with the same
  text that followed the '<<'
END_OF_STRING
```

A here document consists of lines in the source up to, but not including, the terminating string that you specify after the << characters. Normally, this terminator must start in the first column. However, if you put a minus sign after the << characters, you can indent the terminator.

```
print <<-STRING1, <<-STRING2
  Concat
  STRING1
  enate
  STRING2
```

produces:

```
Concat
enate
```

Note that Ruby does not strip leading spaces of the contents of the strings in these cases.

Working with Strings

`String` is probably the largest built-in Ruby class, with more than 75 standard methods. We won't go through them all here; the library reference has a complete list. Instead, we'll look at some common string idioms—things that are likely to pop up during day-to-day programming.

Let's get back to our jukebox. Although it's designed to be connected to the Internet, it also holds copies of some popular songs on a local hard drive. That way, if a squirrel chews through our 'net connection, we'll still be able to entertain the customers.

For historical reasons (are there any other kind?), the list of songs is stored as rows in a flat file. Each row holds the name of the file containing the song, the song's duration, the artist, and the title, all in vertical bar-separated fields. A typical file may start

```
/jazz/j00132.mp3 | 3:45 | Fats    Waller    | Ain't Misbehavin'
/jazz/j00319.mp3 | 2:58 | Louis  Armstrong | Wonderful World
/bggrass/bg0732.mp3| 4:09 | Strength in Numbers | Texas Red
      :                :                :                :
```

Looking at the data, it's clear that we'll be using some of class `String`'s many methods to extract and clean up the fields before we create `Song` objects based on them. At a minimum, we'll need to

- break each line into fields,
- convert the running times from mm:ss to seconds, and
- remove those extra spaces from the artists' names.

Our first task is to split each line into fields, and `String#split` will do the job nicely. In this case, we'll pass `split` a regular expression, `/\s*\|\s*/`, that splits the line into tokens wherever `split` finds a vertical bar, optionally surrounded by spaces. And, because the line read from the file has a trailing newline, we'll use `String#chomp` to strip it off just before we apply the `split`.

```
File.open("songdata") do |song_file|
  songs = SongList.new
  song_file.each do |line|
    file, length, name, title = line.chomp.split(/\s*\|\s*/)
    songs.append(Song.new(title, name, length))
  end
  puts songs[1]
end
```

produces:

```
Song: Wonderful World--Louis    Armstrong (2:58)
```

Unfortunately, whoever created the original file entered the artists' names in columns, so some of them contain extra spaces. These will look ugly on our high-tech, super-twist, flat-panel, Day-Glo display, so we'd better remove these extra spaces before

we go much further. We have many ways of doing this, but probably the simplest is `String#squeeze`, which trims runs of repeated characters. We'll use the `squeeze!` form of the method, which alters the string in place.

```
File.open("songdata") do |song_file|
  songs = SongList.new
  song_file.each do |line|
    file, length, name, title = line.chomp.split(/\s*\|\s*/)
    name.squeeze!(" ")
    songs.append(Song.new(title, name, length))
  end
  puts songs[1]
end
```

produces:

```
Song: Wonderful World--Louis Armstrong (2:58)
```

Finally, we have the minor matter of the time format: the file says 2:58, and we want the number of seconds, 178. We could use `split` again, this time splitting the time field around the colon character.

```
mins, secs = length.split(/:/)
```

Instead, we'll use a related method. `String#scan` is similar to `split` in that it breaks a string into chunks based on a pattern. However, unlike `split`, with `scan` you specify the pattern that you want the chunks to match. In this case, we want to match one or more digits for both the minutes and seconds component. The pattern for one or more digits is `/\d+/.`

```
File.open("songdata") do |song_file|
  songs = SongList.new
  song_file.each do |line|
    file, length, name, title = line.chomp.split(/\s*\|\s*/)
    name.squeeze!(" ")
    mins, secs = length.scan(/\d+/)
    songs.append(Song.new(title, name, mins.to_i*60+secs.to_i))
  end
  puts songs[1]
end
```

produces:

```
Song: Wonderful World--Louis Armstrong (178)
```

Our jukebox has a keyword search capability. Given a word from a song title or an artist's name, it will list all matching tracks. Type in **fats**, and it may come back with songs by Fats Domino, Fats Navarro, and Fats Waller, for example. We'll implement this by creating an indexing class. Feed it an object and some strings, and it will index that object under every word (of two or more characters) that occurs in those strings. This will illustrate a few more of class `String`'s many methods.

```

class WordIndex
  def initialize
    @index = {}
  end
  def add_to_index(obj, *phrases)
    phrases.each do |phrase|
      phrase.scan(/\w[-\w' ']+/) do |word| # extract each word
        word.downcase!
        @index[word] = [] if @index[word].nil?
        @index[word].push(obj)
      end
    end
  end
  def lookup(word)
    @index[word.downcase]
  end
end

```

The `String#scan` method extracts elements from a string that match a regular expression. In this case, the pattern `\w[-\w' ']+` matches any character that can appear in a word, followed by one or more of the things specified in the brackets (a hyphen, another word character, or a single quote). We'll talk more about regular expressions beginning on page 64. To make our searches case insensitive, we map both the words we extract and the words used as keys during the lookup to lowercase. Note the exclamation mark at the end of the first `downcase!` method name. As with the `squeeze!` method we used previously, this is an indication that the method will modify the receiver in place, in this case converting the string to lowercase.¹

We'll extend our `SongList` class to index songs as they're added and add a method to look up a song given a word.

```

class SongList
  def initialize
    @songs = Array.new
    @index = WordIndex.new
  end
  def append(song)
    @songs.push(song)
    @index.add_to_index(song, song.name, song.artist)
    self
  end
  def lookup(word)
    @index.lookup(word)
  end
end

```

1. This code sample contains a minor bug: the song “Gone, Gone, Gone” would get indexed three times. Can you come up with a fix?

Finally, we'll test it all.

```
songs = SongList.new
song_file.each do |line|
  file, length, name, title = line.chomp.split(/\s*\|\s*/)
  name.squeeze!(" ")
  mins, secs = length.scan(/\d+/)
  songs.append(Song.new(title, name, mins.to_i*60+secs.to_i))
end
puts songs.lookup("Fats")
puts songs.lookup("ain't")
puts songs.lookup("RED")
puts songs.lookup("WoRLD")
```

produces:

```
Song: Ain't Misbehavin'--Fats Waller (225)
Song: Ain't Misbehavin'--Fats Waller (225)
Song: Texas Red--Strength in Numbers (249)
Song: Wonderful World--Louis Armstrong (178)
```

In the preceding code, the `lookup` method returns an array of matches. When we pass an array to `puts`, it simply writes each element in turn, separated by a newline.

We could spend the next 50 pages looking at all the methods in class `String`. However, let's move on instead to look at a simpler data type: the range.

Ranges

Ranges occur everywhere: January to December, 0 to 9, rare to well-done, lines 50 through 67, and so on. If Ruby is to help us model reality, it seems natural for it to support these ranges. In fact, Ruby goes one better: it actually uses ranges to implement three separate features: sequences, conditions, and intervals.

Ranges as Sequences

The first and perhaps most natural use of ranges is to express a sequence. Sequences have a start point, an end point, and a way to produce successive values in the sequence. In Ruby, these sequences are created using the `..` and `...` range operators. The two-dot form creates an inclusive range, and the three-dot form creates a range that excludes the specified high value.

```
1..10
'a'..'z'
my_array = [ 1, 2, 3 ]
0...my_array.length
```

In Ruby, unlike in some earlier versions of Perl, ranges are not represented internally as lists: the sequence `1..100000` is held as a Range object containing references to two Fixnum objects. If you need to, you can convert a range to a list using the `to_a` method.

```
(1..10).to_a      → [1, 2, 3, 4, 5, 6, 7, 8, 9, 10]
('bar'..'bat').to_a → ["bar", "bas", "bat"]
```

Ranges implement methods that let you iterate over them and test their contents in a variety of ways.

```
digits = 0..9
digits.include?(5) → true
digits.min        → 0
digits.max        → 9
digits.reject {|i| i < 5 } → [5, 6, 7, 8, 9]
digits.each {|digit| dial(digit) } → 0..9
```

So far we've shown ranges of numbers and strings. However, as you'd expect from an object-oriented language, Ruby can create ranges based on objects that you define. The only constraints are that the objects must respond to `succ` by returning the next object in sequence and the objects must be comparable using `<=>`. Sometimes called the *spaceship operator*, `<=>` compares two values, returning `-1`, `0`, or `+1` depending on whether the first is less than, equal to, or greater than the second.

Here's a simple class that represents rows of # signs. We may want to use it as a text-based version of the jukebox volume control.

```
class VU
  include Comparable
  attr :volume
  def initialize(volume) # 0..9
    @volume = volume
  end
  def inspect
    '#' * @volume
  end
  # Support for ranges
  def <=>(other)
    self.volume <=> other.volume
  end
  def succ
    raise(IndexError, "Volume too big") if @volume >= 9
    VU.new(@volume.succ)
  end
end
```

Because our `VU` class implements `succ` and `<=>`, it can participate in ranges.

```
medium_volume = VU.new(4)..VU.new(7)
medium_volume.to_a → [####, #####, #####, #####]
medium_volume.include?(VU.new(3)) → false
```

Ranges as Conditions

As well as representing sequences, ranges may also be used as conditional expressions. Here, they act as a kind of toggle switch—they turn on when the condition in the first part of the range becomes true, and they turn off when the condition in the second part becomes true. For example, the following code fragment prints sets of lines from standard input, where the first line in each set contains the word *start* and the last line contains the word *end*.

```
while line = gets
  puts line if line =~ /start/ .. line =~ /end/
end
```

Behind the scenes, the range keeps track of the state of each of the tests. We'll show some examples of this in the description of loops that starts on page 94.

1.8

In older versions of Ruby, bare ranges could be used as conditions in `if`, `while`, and similar statements. You could, for example, have written the previous code fragment as

```
while gets
  print if /start/../end/
end
```

This is no longer supported. Unfortunately, no error is raised; the test will simply succeed each time.

Ranges as Intervals

A final use of the versatile range is as an interval test: seeing if some value falls within the interval represented by the range. We do this using `===`, the case equality operator.

```
(1..10) === 5      → true
(1..10) === 15     → false
(1..10) === 3.14159 → true
('a'..'j') === 'c' → true
('a'..'j') === 'z' → false
```

The example of a case expression on page 92 shows this test in action, determining a jazz style given a year.

Regular Expressions

Back on page 59 when we were creating a song list from a file, we used a regular expression to match the field delimiter in the input file. We claimed that the expression `line.split(/\s*\|\s*/)` matched a vertical bar surrounded by optional whitespace. Let's explore regular expressions in more detail to see why this claim is true.

Regular expressions are used to match patterns against strings. Ruby provides built-in support that makes pattern matching and substitution convenient and concise. In this section we'll work through all the main features of regular expressions. We won't cover some details here: have a look at page 309 for more information.

Regular expressions are objects of type `Regexp`. They can be created by calling the constructor explicitly or by using the literal forms `/pattern/` and `%r{pattern}`.

```
a = Regexp.new('^\\s*[a-z]') → /^\\s*[a-z]/
b = /^\\s*[a-z]/           → /^\\s*[a-z]/
c = %r{^\\s*[a-z]}        → /^\\s*[a-z]/
```

1.8

Once you have a regular expression object, you can match it against a string using `Regexp#match(string)` or the match operators `=~` (positive match) and `!~` (negative match). The match operators are defined for both `String` and `Regexp` objects. At least one operand of the match operator must be a regular expression. (In previous versions of Ruby, both could be strings, in which case the second operand was converted into a regular expression behind the scenes.)

```
name = "Fats Waller"
name =~ /a/ → 1
name =~ /z/ → nil
/a/ =~ name → 1
```

The match operators return the character position at which the match occurred. They also have the side effect of setting a whole load of Ruby variables. `$&` receives the part of the string that was matched by the pattern, `$`` receives the part of the string that preceded the match, and `$'` receives the string after the match. We can use this to write a method, `show_regexp`, that illustrates where a particular pattern matches.

```
def show_regexp(a, re)
  if a =~ re
    "#{$`}<<#{ $& }>>#{$'}"
  else
    "no match"
  end
end

show_regexp('very interesting', /t/) → very in<<t>>eresting
show_regexp('Fats Waller', /a/)     → F<<a>>ts Waller
show_regexp('Fats Waller', /ll/)    → Fats Wa<<ll>>er
show_regexp('Fats Waller', /z/)     → no match
```

The match also sets the thread-global variables `$~` and `$1` through `$9`. The variable `$~` is a `MatchData` object (described beginning on page 516) that holds everything you may want to know about the match. `$1`, and so on, hold the values of parts of the match. We'll talk about these later. And for people who cringe when they see these Perl-like variable names, stay tuned. There's good news at the end of the chapter.

Patterns

Every regular expression contains a pattern, which is used to match the regular expression against a string.

Within a pattern, all characters except `.`, `|`, `(`, `)`, `[`, `]`, `{`, `}`, `+`, `\`, `^`, `$`, `*`, and `?` match themselves.

```
show_regexp('kangaroo', /angar/) → k<<angar>>oo
show_regexp('!@%&_-=+', /%&/) → !@<<%&>>_-=+
```

If you want to match one of these special characters literally, precede it with a backslash. This explains part of the pattern we used to split the song line, `/\s*\|\s*/`. The `\|` means “match a vertical bar.” Without the backslash, the `|` would have meant *alternation* (which we’ll describe later).

```
show_regexp('yes | no', /\|/) → yes <<|>> no
show_regexp('yes (no)', /\(no\)\/) → yes <<(no)>>
show_regexp('are you sure?', /e\?/) → are you sur<<e?>>
```

A backslash followed by an alphanumeric character is used to introduce a special match construct, which we’ll cover later. In addition, a regular expression may contain `#{...}` expression substitutions.

Anchors

By default, a regular expression will try to find the first match for the pattern in a string. Match `/iss/` against the string “Mississippi,” and it will find the substring “iss” starting at position one. But what if you want to force a pattern to match only at the start or end of a string?

The patterns `^` and `$` match the beginning and end of a line, respectively. These are often used to *anchor* a pattern match: for example, `/^option/` matches the word *option* only if it appears at the start of a line. The sequence `\A` matches the beginning of a string, and `\z` and `\Z` match the end of a string. (Actually, `\Z` matches the end of a string *unless* the string ends with a `\n`, in which case it matches just before the `\n`.)

```
show_regexp("this is\nthe time", /^the/) → this is\n<<the>> time
show_regexp("this is\nthe time", /is$/) → this <<is>>\nthe time
show_regexp("this is\nthe time", /\Athis/) → <<this>> is\nthe time
show_regexp("this is\nthe time", /\Athe/) → no match
```

Similarly, the patterns `\b` and `\B` match word boundaries and nonword boundaries, respectively. Word characters are letters, numbers, and underscores.

```
show_regexp("this is\nthe time", /\bis/) → this <<is>>\nthe time
show_regexp("this is\nthe time", /\Bis/) → th<<is>> is\nthe time
```

Character Classes

A *character class* is a set of characters between brackets: `[characters]` matches any single character between the brackets. `[aeiou]` will match a vowel, `[, . ; ! ?]` matches punctuation, and so on. The significance of the special regular expression characters—`. | () [{ + ^ $ * ?`—is turned off inside the brackets. However, normal string substitution still occurs, so (for example) `\b` represents a backspace character and `\n` a newline (see Table 22.2 on page 306). In addition, you can use the abbreviations shown in Table 5.1 on the following page so that (for example) `\s` matches any whitespace character, not just a literal space. The POSIX character classes in the second half of the table correspond to the `ctype(3)` macros of the same names.

```
show_regexp('Price $12.', /[aeiou]/)      → Pr<<i>>ce $12.
show_regexp('Price $12.', /\s/)           → Price<< >>$12.
show_regexp('Price $12.', /[[:digit:]]/)   → Price $<<1>>2.
show_regexp('Price $12.', /[[:space:]]/)   → Price<< >>$12.
show_regexp('Price $12.', /[[:punct:]]aeiou/) → Pr<<i>>ce $12.
```

Within the brackets, the sequence c_1 - c_2 represents all the characters between c_1 and c_2 , inclusive.

```
a = 'see [Design Patterns-page 123]'
show_regexp(a, /[A-F]/)      → see [<<D>>esign Patterns-page 123]
show_regexp(a, /[A-Fa-f]/)   → s<<e>>e [Design Patterns-page 123]
show_regexp(a, /[0-9]/)      → see [Design Patterns-page <<1>>23]
show_regexp(a, /[0-9][0-9]/) → see [Design Patterns-page <<12>>3]
```

If you want to include the literal characters `]` and `-` within a character class, they must appear at the start. Put a `^` immediately after the opening bracket to negate a character class: `[^a-z]` matches any character that isn't a lowercase alphabetic.

```
a = 'see [Design Patterns-page 123]'
show_regexp(a, /[]/)        → see [Design Patterns-page 123<<]>>
show_regexp(a, /[-]/)       → see [Design Patterns<<->>page 123]
show_regexp(a, /^[^a-z]/)   → see<< >>[Design Patterns-page 123]
show_regexp(a, /^[^a-z\s]/) → see <<[]>>Design Patterns-page 123]
```

Some character classes are used so frequently that Ruby provides abbreviations for them. These abbreviations are listed in Table 5.1 on the next page—they may be used both within brackets and in the body of a pattern.

```
show_regexp('It costs $12.', /\s/) → It<< >>costs $12.
show_regexp('It costs $12.', /\d/) → It costs $<<1>>2.
```

Finally, a period (`.`) appearing outside brackets represents any character except a newline (though in multiline mode it matches a newline, too).

```
a = 'It costs $12.'
show_regexp(a, /c.s/) → It <<cos>>ts $12.
show_regexp(a, /./)  → <<I>>t costs $12.
show_regexp(a, /\./) → It costs $12<<.>>
```

Table 5.1. Character class abbreviations

Sequence	As [...]	Meaning
<code>\d</code>	<code>[0-9]</code>	Digit character
<code>\D</code>	<code>[^0-9]</code>	Any character except a digit
<code>\s</code>	<code>[\s\t\r\n\f]</code>	Whitespace character
<code>\S</code>	<code>[^\s\t\r\n\f]</code>	Any character except whitespace
<code>\w</code>	<code>[A-Za-z0-9_]</code>	Word character
<code>\W</code>	<code>[^A-Za-z0-9_]</code>	Any character except a word character

POSIX Character Classes	
<code>[:alnum:]</code>	Alphanumeric
<code>[:alpha:]</code>	Uppercase or lowercase letter
<code>[:blank:]</code>	Blank and tab
<code>[:cntrl:]</code>	Control characters (at least 0x00–0x1f, 0x7f)
<code>[:digit:]</code>	Digit
<code>[:graph:]</code>	Printable character excluding space
<code>[:lower:]</code>	Lowercase letter
<code>[:print:]</code>	Any printable character (including space)
<code>[:punct:]</code>	Printable character excluding space and alphanumeric
<code>[:space:]</code>	Whitespace (same as <code>\s</code>)
<code>[:upper:]</code>	Uppercase letter
<code>[:xdigit:]</code>	Hex digit (0–9, a–f, A–F)

Repetition

When we specified the pattern that split the song list line, `/\s*\|\s*/`, we said we wanted to match a vertical bar surrounded by an arbitrary amount of whitespace. We now know that the `\s` sequences match a single whitespace character, so it seems likely that the asterisks somehow mean “an arbitrary amount.” In fact, the asterisk is one of a number of modifiers that allow you to match multiple occurrences of a pattern.

If *r* stands for the immediately preceding regular expression within a pattern, then

<code>r*</code>	matches zero or more occurrences of <i>r</i> .
<code>r+</code>	matches one or more occurrences of <i>r</i> .
<code>r?</code>	matches zero or one occurrence of <i>r</i> .
<code>r{m,n}</code>	matches at least “m” and at most “n” occurrences of <i>r</i> .
<code>r{m,}</code>	matches at least “m” occurrences of <i>r</i> .
<code>r{m}</code>	matches exactly “m” occurrences of <i>r</i> .

These repetition constructs have a high precedence—they bind only to the immediately preceding regular expression in the pattern. `/ab+/` matches an *a* followed by one or

more *b*'s, not a sequence of *ab*'s. You have to be careful with the *** construct too—the pattern */a*/* will match any string; every string has zero or more *a*'s.

These patterns are called *greedy*, because by default they will match as much of the string as they can. You can alter this behavior, and have them match the minimum, by adding a question mark suffix.

```
a = "The moon is made of cheese"
show_regexp(a, /\w+/)           → <<The>> moon is made of cheese
show_regexp(a, /\s.*\s/)       → The<< moon is made of >>cheese
show_regexp(a, /\s.*?\s/)      → The<< moon >>is made of cheese
show_regexp(a, /[aeiou]{2,99}/) → The m<<oo>>n is made of cheese
show_regexp(a, /mo?o/)         → The <<mo>>n is made of cheese
```

Alternation

We know that the vertical bar is special, because our line-splitting pattern had to escape it with a backslash. That's because an unescaped vertical bar (*|*) matches either the regular expression that precedes it or the regular expression that follows it.

```
a = "red ball blue sky"
show_regexp(a, /d|e/)          → r<<e>>d ball blue sky
show_regexp(a, /al|lu/)       → red b<<al>>l blue sky
show_regexp(a, /red ball|angry sky/) → <<red ball>> blue sky
```

There's a trap for the unwary here, as *|* has a very low precedence. The last example above matches *red ball* or *angry sky*, not *red ball sky* or *red angry sky*. To match *red ball sky* or *red angry sky*, you'd need to override the default precedence using grouping.

Grouping

You can use parentheses to group terms within a regular expression. Everything within the group is treated as a single regular expression.

```
show_regexp('banana', /an*/)   → b<<an>>ana
show_regexp('banana', /(an)*/) → <<>>banana
show_regexp('banana', /(an)+/) → b<<anan>>a

a = 'red ball blue sky'
show_regexp(a, /blue|red/)      → <<red>> ball blue sky
show_regexp(a, /(blue|red) \w+/) → <<red ball>> blue sky
show_regexp(a, /(red|blue) \w+/) → <<red ball>> blue sky
show_regexp(a, /red|blue \w+/)  → <<red>> ball blue sky

show_regexp(a, /red (ball|angry) sky/) → no match
a = 'the red angry sky'
show_regexp(a, /red (ball|angry) sky/) → the <<red angry sky>>
```

Parentheses also collect the results of pattern matching. Ruby counts opening parentheses, and for each stores the result of the partial match between it and the corresponding closing parenthesis. You can use this partial match both within the rest of the pattern

and in your Ruby program. Within the pattern, the sequence `\1` refers to the match of the first group, `\2` the second group, and so on. Outside the pattern, the special variables `$1`, `$2`, and so on, serve the same purpose.

```
"12:50am" =~ /\d\d:\d\d(..)/ → 0
"Hour is #1, minute #2" → "Hour is 12, minute 50"
"12:50am" =~ /((\d\d):(\d\d))(..)/ → 0
"Time is #1" → "Time is 12:50"
"Hour is #2, minute #3" → "Hour is 12, minute 50"
"AM/PM is #4" → "AM/PM is am"
```

The ability to use part of the current match later in that match allows you to look for various forms of repetition.

```
# match duplicated letter
show_regexp('He said "Hello"', /(\w)\1/) → He said "He<<ll>>o"
# match duplicated substrings
show_regexp('Mississippi', /(\w+)\1/) → M<<ississ>>ippi
```

You can also use back references to match delimiters.

```
show_regexp('He said "Hello"', /(['']).*?\1/) → He said
<<"Hello">>
show_regexp("He said 'Hello'", /(['']).*?\1/) → He said
<<'Hello'>>
```

Pattern-Based Substitution

Sometimes finding a pattern in a string is good enough. If a friend challenges you to find a word that contains the letters *a*, *b*, *c*, *d*, and *e* in order, you could search a word list with the pattern `/a.*b.*c.*d.*e/` and find *abjectedness*, *absconded*, *ambuscade*, and *carbacidometer*, among others. That has to be worth something.

However, sometimes you need to change things based on a pattern match. Let's go back to our song list file. Whoever created it entered all the artists' names in lowercase. When we display them on our jukebox's screen, they'd look better in mixed case. How can we change the first character of each word to uppercase?

The methods `String#sub` and `String#gsub` look for a portion of a string matching their first argument and replace it with their second argument. `String#sub` performs one replacement, and `String#gsub` replaces every occurrence of the match. Both routines return a new copy of the `String` containing the substitutions. Mutator versions `String#sub!` and `String#gsub!` modify the original string.

```
a = "the quick brown fox"
a.sub(/[aeiou]/, '*') → "th* quick brown fox"
a.gsub(/[aeiou]/, '*') → "th* q**ck br*wn f*x"
a.sub(/\s\S+/, '') → "the brown fox"
a.gsub(/\s\S+/, '') → "the"
```

The second argument to both functions can be either a `String` or a block. If a block is used, it is passed the matching substring, and the block's value is substituted into the original string.

```
a = "the quick brown fox"
a.sub(/^./) {|match| match.upcase } → "The quick brown fox"
a.gsub(/[aeiou]/) {|vowel| vowel.upcase } → "thE qUIck brOwn fOx"
```

So, this looks like the answer to converting our artists' names. The pattern that matches the first character of a word is `\b\w`—look for a word boundary followed by a word character. Combine this with `gsub`, and we can hack the artists' names.

```
def mixed_case(name)
  name.gsub(/\b\w/) {|first| first.upcase }
end

mixed_case("fats waller") → "Fats Waller"
mixed_case("louis armstrong") → "Louis Armstrong"
mixed_case("strength in numbers") → "Strength In Numbers"
```

Backslash Sequences in the Substitution

Earlier we noted that the sequences `\1`, `\2`, and so on, are available in the pattern, standing for the *n*th group matched so far. The same sequences are available in the second argument of `sub` and `gsub`.

```
"fred:smith".sub(/(\w+):(\w+)/, '\2, \1') → "smith, fred"
"nercpyitno".gsub(/(.) (.)/, '\2\1') → "encryption"
```

Additional backslash sequences work in substitution strings: `&` (last match), `+` (last matched group), ``` (string prior to match), `'` (string after match), and `\\` (a literal backslash).

It gets confusing if you want to include a literal backslash in a substitution. The obvious thing is to write

```
str.gsub(/\\/, '\\\\')
```

Clearly, this code is trying to replace each backslash in `str` with two. The programmer doubled up the backslashes in the replacement text, knowing that they'd be converted to `\\` in syntax analysis. However, when the substitution occurs, the regular expression engine performs another pass through the string, converting `\\` to `\`, so the net effect is to replace each single backslash with another single backslash. You need to write `gsub(/\\/, '\\\\\\\\\\\\')`!

```
str = 'a\b\c' → "a\b\c"
str.gsub(/\\/, '\\\\\\\\\\\\') → "a\\b\\c"
```

However, using the fact that `&` is replaced by the matched string, you could also write

```
str = 'a\b\c' → "a\b\c"
str.gsub(/\\/, '\&\&') → "a\\b\\c"
```

If you use the block form of `gsub`, the string for substitution is analyzed only once (during the syntax pass) and the result is what you intended.

```
str = 'a\b\c'          → "a\b\c"
str.gsub(/\b/) { '\\\\' } → "a\\b\\c"
```

Finally, as an example of the wonderful expressiveness of combining regular expressions with code blocks, consider the following code fragment from the CGI library module, written by Wakou Aoyama. The code takes a string containing HTML escape sequences and converts it into normal ASCII. Because it was written for a Japanese audience, it uses the `n` modifier on the regular expressions, which turns off wide-character processing. It also illustrates Ruby's case expression, which we discuss starting on page 92.

```
def unescapeHTML(string)
  str = string.dup
  str.gsub!(/&(.*?);/n) {
    match = $1.dup
    case match
    when /\Aamp\z/ni          then '&'
    when /\Aquot\z/ni        then '"'
    when /\Agt\z/ni          then '>'
    when /\Alt\z/ni          then '<'
    when /\A#(\d+)\z/n       then Integer($1).chr
    when /\A#x([0-9a-f]+)\z/ni then $1.hex.chr
    end
  }
  str
end

puts unescapeHTML("1<2 && 4>3")
puts unescapeHTML("&quot;A&quot; = &#65; = &#x41;")
```

produces:

```
1<2 && 4>3
"A" = A = A
```

Object-Oriented Regular Expressions

We have to admit that while all these weird variables are very convenient to use, they aren't very object oriented, and they're certainly cryptic. And didn't we say that everything in Ruby was an object? What has gone wrong here?

Nothing, really. It's just that when Matz designed Ruby, he produced a fully object-oriented regular expression handling system. He then made it look familiar to Perl programmers by wrapping all these `$`-variables on top of it all. The objects and classes are still there, underneath the surface. So let's spend a while digging them out.

We've already come across one class: regular expression literals create instances of class `Regexp` (documented beginning on page 579).

```
re = /cat/
re.class → Regexp
```

The method `Regexp#match` matches a regular expression against a string. If unsuccessful, the method returns `nil`. On success, it returns an instance of class `MatchData`, documented beginning on page 516. And that `MatchData` object gives you access to all available information about the match. All that good stuff that you can get from the `$`-variables is bundled in a handy little object.

```
re = /(\d+):(\d+)/ # match a time hh:mm
md = re.match("Time: 12:34am")
md.class → MatchData
md[0] # == $& → "12:34"
md[1] # == $1 → "12"
md[2] # == $2 → "34"
md.pre_match # == $` → "Time: "
md.post_match # == $' → "am"
```

Because the match data is stored in its own object, you can keep the results of two or more pattern matches available at the same time, something you can't do using the `$`-variables. In the next example, we're matching the same `Regexp` object against two strings. Each match returns a unique `MatchData` object, which we verify by examining the two subpattern fields.

```
re = /(\d+):(\d+)/ # match a time hh:mm
md1 = re.match("Time: 12:34am")
md2 = re.match("Time: 10:30pm")
md1[1, 2] → ["12", "34"]
md2[1, 2] → ["10", "30"]
```

So how do the `$`-variables fit in? Well, after every pattern match, Ruby stores a reference to the result (`nil` or a `MatchData` object) in a thread-local variable (accessible using `$~`). All the other regular expression variables are then derived from this object. Although we can't really think of a use for the following code, it demonstrates that all the other `MatchData`-related `$`-variables are indeed slaved off the value in `$~`.

```
re = /(\d+):(\d+)/
md1 = re.match("Time: 12:34am")
md2 = re.match("Time: 10:30pm")
[ $1, $2 ] # last successful match → ["10", "30"]
$~ = md1
[ $1, $2 ] # previous successful match → ["12", "34"]
```

Having said all this, we have to 'fess up. We normally use the `$`-variables rather than worrying about `MatchData` objects. For everyday use, they just end up being more convenient. Sometimes we just can't help being pragmatic.

More about Methods

So far in this book, we’ve been defining and using methods without much thought. Now it’s time to get into the details.

Defining a Method

As we’ve seen, a method is defined using the keyword `def`. Method names should begin with a lowercase letter.¹ Methods that act as queries are often named with a trailing `?`, such as `instance_of?`. Methods that are “dangerous,” or modify the receiver, may be named with a trailing `!`. For instance, `String` provides both a `chop` and a `chop!`. The first one returns a modified string; the second modifies the receiver in place. And methods that can be assigned to (a feature we discussed on page 29) end with an equals sign (`=`). `?`, `!`, and `=` are the only “weird” characters allowed as method name suffixes.

Now that we’ve specified a name for our new method, we may need to declare some parameters. These are simply a list of local variable names in parentheses. (The parentheses are optional around a method’s arguments; our convention is to use them when a method has arguments and omit them when it doesn’t.)

```
def my_new_method(arg1, arg2, arg3)    # 3 arguments
  # Code for the method would go here
end
def my_other_new_method                # No arguments
  # Code for the method would go here
end
```

Ruby lets you specify default values for a method’s arguments—values that will be used if the caller doesn’t pass them explicitly. You do this using the assignment operator.

1. You won’t get an immediate error if you use an uppercase letter, but when Ruby sees you calling the method, it will first guess that it is a constant, not a method invocation, and as a result it may parse the call incorrectly.

```
def cool_dude(arg1="Miles", arg2="Coltrane", arg3="Roach")
  "#{arg1}, #{arg2}, #{arg3}."
end

cool_dude                                → "Miles, Coltrane, Roach."
cool_dude("Bart")                          → "Bart, Coltrane, Roach."
cool_dude("Bart", "Elwood")                → "Bart, Elwood, Roach."
cool_dude("Bart", "Elwood", "Linus")      → "Bart, Elwood, Linus."
```

1.8

The body of a method contains normal Ruby expressions, except that you may not define a nonsingleton class or module within a method. If you define a method inside another method, the inner method gets defined when the outer method executes. The return value of a method is the value of the last expression executed or the result of an explicit return expression.

Variable-Length Argument Lists

But what if you want to pass in a variable number of arguments or want to capture multiple arguments into a single parameter? Placing an asterisk before the name of the parameter after the “normal” parameters does just that.

```
def varargs(arg1, *rest)
  "Got #{arg1} and #{rest.join(', ')}"
end

varargs("one")                            → "Got one and "
varargs("one", "two")                     → "Got one and two"
varargs "one", "two", "three"             → "Got one and two, three"
```

In this example, the first argument is assigned to the first method parameter as usual. However, the next parameter is prefixed with an asterisk, so all the remaining arguments are bundled into a new Array, which is then assigned to that parameter.

Methods and Blocks

As we discussed in the section on blocks and iterators beginning on page 46, when a method is called, it may be associated with a block. Normally, you simply call the block from within the method using `yield`.

```
def take_block(p1)
  if block_given?
    yield(p1)
  else
    p1
  end
end

take_block("no block")                     → "no block"
take_block("no block") {|s| s.sub(/no /, '') } → "block"
```

However, if the last parameter in a method definition is prefixed with an ampersand, any associated block is converted to a Proc object, and that object is assigned to the parameter.

```
class TaxCalculator
  def initialize(name, &block)
    @name, @block = name, block
  end
  def get_tax(amount)
    "#@name on #{amount} = #{ @block.call(amount) }"
  end
end

tc = TaxCalculator.new("Sales tax") {|amt| amt * 0.075 }

tc.get_tax(100) → "Sales tax on 100 = 7.5"
tc.get_tax(250) → "Sales tax on 250 = 18.75"
```

Calling a Method

You call a method by specifying a receiver, the name of the method, and optionally some parameters and an optional block.

```
connection.download_MP3("jitterbug") {|p| show_progress(p) }
```

In this example, the object `connection` is the receiver, `download_MP3` is the name of the method, `"jitterbug"` is the parameter, and the stuff between the braces is the associated block.

For class and module methods, the receiver will be the class or module name.

```
File.size("testfile") → 66
Math.sin(Math::PI/4) → 0.707106781186548
```

If you omit the receiver, it defaults to `self`, the current object.

```
self.class → Object
self.frozen? → false
frozen? → false
self.id → 967900
id → 967900
```

This defaulting mechanism is how Ruby implements private methods. Private methods may *not* be called with a receiver, so they must be methods available in the current object.

Also, in the previous example we called `self.class`, but we could not call the method `class` without a receiver. This is because `class` is also a keyword in Ruby (it introduces class definitions), so its stand-alone use would generate a syntax error.

The optional parameters follow the method name. If no ambiguity exists, you can omit the parentheses around the argument list when calling a method.² However, except in the simplest cases we don't recommend this—some subtle problems can trip you up.³ Our rule is simple: if you have any doubt, use parentheses.

```
a = obj.hash      # Same as
a = obj.hash()   # this.
obj.some_method "Arg1", arg2, arg3 # Same thing as
obj.some_method("Arg1", arg2, arg3) # with parentheses.
```

1.8

Older Ruby versions compounded the problem by allowing you to put spaces between the method name and the opening parenthesis. This made it hard to parse: is the parenthesis the start of the parameters or the start of an expression? As of Ruby 1.8 you get a warning if you put a space between a method name and an open parenthesis.

Method Return Values

Every called method returns a value (although no rule says you have to use that value). The value of a method is the value of the last statement executed during the method's execution. Ruby has a `return` statement, which exits from the currently executing method. The value of a `return` is the value of its argument(s). It is idiomatic Ruby to omit the `return` if it isn't needed.

```
def meth_one
  "one"
end
meth_one → "one"

def meth_two(arg)
  case
  when arg > 0
    "positive"
  when arg < 0
    "negative"
  else
    "zero"
  end
end

meth_two(23) → "positive"
meth_two(0)  → "zero"
```

-
2. Other Ruby documentation sometimes calls these method calls without parentheses *commands*.
 3. In particular, you *must* use parentheses on a method call that is itself a parameter to another method call (unless it is the last parameter).

```
def meth_three
  100.times do |num|
    square = num*num
    return num, square if square > 1000
  end
end
meth_three → [32, 1024]
```

As the last case illustrates, if you give return multiple parameters, the method returns them in an array. You can use parallel assignment to collect this return value.

```
num, square = meth_three
num → 32
square → 1024
```

Expanding Arrays in Method Calls

Earlier we saw that if you put an asterisk in front of a formal parameter in a method definition, multiple arguments in the call to the method will be bundled into an array. Well, the same thing works in reverse.

When you call a method, you can explode an array, so that each of its members is taken as a separate parameter. Do this by prefixing the array argument (which must follow all the regular arguments) with an asterisk.

```
def five(a, b, c, d, e)
  "I was passed #{a} #{b} #{c} #{d} #{e}"
end

five(1, 2, 3, 4, 5) → "I was passed 1 2 3 4 5"
five(1, 2, 3, *['a', 'b']) → "I was passed 1 2 3 a b"
five(*(10..14).to_a) → "I was passed 10 11 12 13 14"
```

Making Blocks More Dynamic

We've already seen how to associate a block with a method call.

```
list_bones("aardvark") do |bone|
  # ...
end
```

Normally, this is perfectly good enough—you associate a fixed block of code with a method in the same way you'd have a chunk of code after an `if` or `while` statement.

Sometimes, however, you'd like to be more flexible. For example, we may be teaching math skills.⁴ The student could ask for an *n*-plus table or an *n*-times table. If the student

4. Of course, Andy and Dave would have to *learn* math skills first. Conrad Schneiker reminded us that there are three kinds of people: those who can count and those who can't.

asked for a 2-times table, we'd output 2, 4, 6, 8, and so on. (This code does not check its inputs for errors.)

```
print "(t)imes or (p)lus: "
times = gets
print "number: "
number = Integer(gets)
if times =~ /^t/
  puts((1..10).collect {|n| n*number }.join(", "))
else
  puts((1..10).collect {|n| n+number }.join(", "))
end
```

produces:

```
(t)imes or (p)lus: t
number: 2
2, 4, 6, 8, 10, 12, 14, 16, 18, 20
```

This works, but it's ugly, with virtually identical code on each branch of the `if` statement. It would be nice if we could factor out the block that does the calculation.

```
print "(t)imes or (p)lus: "
times = gets
print "number: "
number = Integer(gets)
if times =~ /^t/
  calc = lambda {|n| n*number }
else
  calc = lambda {|n| n+number }
end
puts((1..10).collect(&calc).join(", "))
```

produces:

```
(t)imes or (p)lus: t
number: 2
2, 4, 6, 8, 10, 12, 14, 16, 18, 20
```

If the last argument to a method is preceded by an ampersand, Ruby assumes that it is a Proc object. It removes it from the parameter list, converts the Proc object into a block, and associates it with the method.

Collecting Hash Arguments

Some languages feature *keyword arguments*—that is, instead of passing arguments in a given order and quantity, you pass the name of the argument with its value, in any order. Ruby 1.8 does not have keyword arguments (making us liars, because in the previous version of this book we said it would have. Perhaps in Ruby 2.0). In the meantime, people are using hashes as a way of achieving the same effect. For example, we could consider adding a more powerful named-search facility to our `SongList`.

```

class SongList
  def create_search(name, params)
    # ...
  end
end
list.create_search("short jazz songs",
  {
    'genre'           => "jazz",
    'duration_less_than' => 270
  })

```

The first parameter is the search name, and the second is a hash literal containing search parameters. The use of a hash means we can simulate keywords: look for songs with a genre of “jazz” and a duration less than $4\frac{1}{2}$ minutes. However, this approach is slightly clunky, and that set of braces could easily be mistaken for a block associated with the method. So, Ruby has a shortcut. You can place *key => value* pairs in an argument list, as long as they follow any normal arguments and precede any array and block arguments. All these pairs will be collected into a single hash and passed as one argument to the method. No braces are needed.

```

list.create_search('short jazz songs',
  'genre'           => 'jazz',
  'duration_less_than' => 270)

```

Finally, in idiomatic Ruby you’d probably use symbols rather than strings, as symbols make it clearer that you’re referring to the name of something.

```

list.create_search('short jazz songs',
  :genre           => :jazz,
  :duration_less_than => 270)

```

A well-written Ruby program will typically contain many methods, each quite small, so it’s worth getting familiar with the options available when defining and using Ruby methods.

Expressions

So far we've been fairly cavalier in our use of expressions in Ruby. After all, $a = b + c$ is pretty standard stuff. You could write a whole heap of Ruby code without reading any of this chapter.

But it wouldn't be as much fun ;-).

One of the first differences with Ruby is that anything that can reasonably return a value does: just about everything is an expression. What does this mean in practice?

Some obvious things include the ability to chain statements together.

```
a = b = c = 0           → 0
[ 3, 1, 7, 0 ].sort.reverse → [7, 3, 1, 0]
```

Perhaps less obvious, things that are normally statements in C or Java are expressions in Ruby. For example, the `if` and `case` statements both return the value of the last expression executed.

```
song_type = if song.mp3_type == MP3::Jazz
              if song.written < Date.new(1935, 1, 1)
                Song::TradJazz
              else
                Song::Jazz
              end
            else
              Song::Other
            end

rating = case votes_cast
          when 0...10 then Rating::SkipThisOne
          when 10...50 then Rating::CouldDoBetter
          else Rating::Rave
          end
```

We'll talk more about `if` and `case` starting on page [90](#).

Operator Expressions

Ruby has the basic set of operators (+, -, *, /, and so on) as well as a few surprises. A complete list of the operators, and their precedences, is given in Table 22.4 on page 324.

In Ruby, many operators are actually implemented as method calls. For example, when you write `a*b+c` you're actually asking the object referenced by `a` to execute the method `*`, passing in the parameter `b`. You then ask the object that results from that calculation to execute the `+` method, passing `c` as a parameter. This is equivalent to writing

```
(a.*(b)).+(c)
```

Because everything is an object, and because you can redefine instance methods, you can always redefine basic arithmetic if you don't like the answers you're getting.

```
class Fixnum
  alias old_plus +

  # Redefine addition of Fixnums. This
  # is a BAD IDEA!
  def +(other)
    old_plus(other).succ
  end
end

1 + 2      →  4
a = 3
a += 4     →  8
a + a + a  → 26
```

More useful is that classes you write can participate in operator expressions just as if they were built-in objects. For example, we may want to be able to extract a number of seconds of music from the middle of a song. We could do this using the indexing operator `[]` to specify the music to be extracted.

```
class Song
  def [](from_time, to_time)
    result = Song.new(self.title + " [extract]",
                     self.artist,
                     to_time - from_time)
    result.set_start_time(from_time)
    result
  end
end
```

This code fragment extends class `Song` with the method `[]`, which takes two parameters (a start time and an end time). It returns a new song, with the music clipped to the given interval. We could then play the introduction to a song with code such as

```
song[0, 15].play
```

Miscellaneous Expressions

As well as the obvious operator expressions and method calls, and the (perhaps) less obvious statement expressions (such as `if` and `case`), Ruby has a few more things that you can use in expressions.

Command Expansion

If you enclose a string in backquotes (sometimes called backticks), or use the delimited form prefixed by `%x`, it will (by default) be executed as a command by your underlying operating system. The value of the expression is the standard output of that command. Newlines will not be stripped, so it is likely that the value you get back will have a trailing return or linefeed character.

```

`date`           → "Thu Oct 21 16:01:42 CDT 2004\n"
`ls`.split[34]  → "book.bbl"
%x{echo "Hello there"} → "Hello there\n"

```

You can use expression expansion and all the usual escape sequences in the command string.

```

for i in 0..3
  status = `dbmanager status id=#{i}`
  # ...
end

```

The exit status of the command is available in the global variable `$?` .

Redefining Backquotes

In the description of the command output expression, we said that the string in backquotes would “by default” be executed as a command. In fact, the string is passed to the method called `Kernel.`` (a single backquote). If you want, you can override this.

```

alias old_backquote `
def `(cmd)
  result = old_backquote(cmd)
  if $? != 0
    fail "Command #{cmd} failed: #{?}"
  end
  result
end
print `date`
print `data`

```

produces:

```

Thu Oct 21 16:01:42 CDT 2004
prog.rb:10: command not found: data
prog.rb:5:in ``': Command data failed: 32512 (RuntimeError)
from prog.rb:10

```

Assignment

Just about every example we've given so far in this book has featured assignment. Perhaps it's about time we said something about it.

An assignment statement sets the variable or attribute on its left side (the *lvalue*) to refer to the value on the right (the *rvalue*). It then returns that value as the result of the assignment expression. This means you can chain assignments, and you can perform assignments in some unexpected places.

```
a = b = 1 + 2 + 3
a → 6
b → 6
a = (b = 1 + 2) + 3
a → 6
b → 3
File.open(name = gets.chomp)
```

Ruby has two basic forms of assignment. The first assigns an object reference to a variable or constant. This form of assignment is hardwired into the language.

```
instrument = "piano"
MIDDLE_A = 440
```

The second form of assignment involves having an object attribute or element reference on the left side.

```
song.duration = 234
instrument["ano"] = "ccolo"
```

These forms are special, because they are implemented by calling methods in the *lvalues*, which means you can override them.

We've already seen how to define a writable object attribute. Simply define a method name ending in an equals sign. This method receives as its parameter the assignment's *rvalue*.

```
class Song
  def duration=(new_duration)
    @duration = new_duration
  end
end
```

These attribute-setting methods don't have to correspond with internal instance variables, and you don't need an attribute reader for every attribute writer (or vice versa).

```
class Amplifier
  def volume=(new_volume)
    self.left_channel = self.right_channel = new_volume
  end
end
```

1.8

In older Ruby versions, the result of the assignment was the value returned by the attribute-setting method. In Ruby 1.8, the value of the assignment is *always* the value of the parameter; the return value of the method is discarded.

```
class Test
  def val=(val)
    @val = val
    return 99
  end
end

t = Test.new
a = t.val = 2
a → 2
```

In older versions of Ruby, `a` would be set to 99 by the assignment, and in Ruby 1.8 it will be set to 2.

Parallel Assignment

During your first week in a programming course (or the second semester if it was a party school), you may have had to write code to swap the values in two variables.

```
int a = 1;
int b = 2;
int temp;
temp = a;
a = b;
b = temp;
```

You can do this much more cleanly in Ruby.

```
a, b = b, a
```

Ruby assignments are effectively performed in parallel, so the values assigned are not affected by the assignment itself. The values on the right side are evaluated in the order in which they appear before any assignment is made to variables or attributes on the left. A somewhat contrived example illustrates this. The second line assigns to the variables `a`, `b`, and `c` the values of the expressions `x`, `x += 1`, and `x += 1`, respectively.

```
x = 0 → 0
a, b, c = x, (x += 1), (x += 1) → [0, 1, 2]
```

When an assignment has more than one lvalue, the assignment expression returns an array of the rvalues. If an assignment contains more lvalues than rvalues, the excess lvalues are set to `nil`. If a multiple assignment contains more rvalues than lvalues, the extra rvalues are ignored. If an assignment has just one lvalue and multiple rvalues, the rvalues are converted to an array and assigned to the lvalue.

Using Accessors within a Class

Why did we write `self.left_channel` in the example on page 84? Well, writable attributes have a hidden gotcha. Normally, methods within a class can invoke other methods in the same class and its superclasses in functional form (that is, with an implicit receiver of `self`). However, this doesn't work with attribute writers. Ruby sees the assignment and decides that the name on the left must be a local variable, not a method call to an attribute writer.

```
class BrokenAmplifier
  attr_accessor :left_channel, :right_channel
  def volume=(vol)
    left_channel = self.right_channel = vol
  end
end

ba = BrokenAmplifier.new
ba.left_channel = ba.right_channel = 99
ba.volume = 5
ba.left_channel → 99
ba.right_channel → 5
```

We forgot to put “`self.`” in front of the assignment to `left_channel`, so Ruby stored the new value in a local variable of method `volume=`; the object's attribute never got updated. This can be a tricky bug to track down.

You can collapse and expand arrays using Ruby's parallel assignment operator. If the last lvalue is preceded by an asterisk, all the remaining rvalues will be collected and assigned to that lvalue as an array. Similarly, if the last rvalue is an array, you can prefix it with an asterisk, which effectively expands it into its constituent values in place. (This is not necessary if the rvalue is the only thing on the right side—the array will be expanded automatically.)

```
a = [1, 2, 3, 4]
b, c = a → b == 1, c == 2
b, *c = a → b == 1, c == [2, 3, 4]
b, c = 99, a → b == 99, c == [1, 2, 3, 4]
b, *c = 99, a → b == 99, c == [[1, 2, 3, 4]]
b, c = 99, *a → b == 99, c == 1
b, *c = 99, *a → b == 99, c == [1, 2, 3, 4]
```

Nested Assignments

Parallel assignments have one more feature worth mentioning. The left side of an assignment may contain a parenthesized list of terms. Ruby treats these terms as if they

were a nested assignment statement. It extracts the corresponding rvalue, assigning it to the parenthesized terms, before continuing with the higher-level assignment.

```

b, (c, d), e = 1,2,3,4      →  b == 1, c == 2, d == nil,   e == 3
b, (c, d), e = [1,2,3,4]  →  b == 1, c == 2, d == nil,   e == 3
b, (c, d), e = 1,[2,3],4  →  b == 1, c == 2, d == 3,     e == 4
b, (c, d), e = 1,[2,3,4],5 →  b == 1, c == 2, d == 3,     e == 5
b, (c,*d), e = 1,[2,3,4],5 →  b == 1, c == 2, d == [3, 4], e == 5

```

Other Forms of Assignment

In common with many other languages, Ruby has a syntactic shortcut: `a = a + 2` may be written as `a += 2`.

The second form is converted internally to the first. This means that operators you have defined as methods in your own classes work as you'd expect.

```

class Bowdlerize
  def initialize(string)
    @value = string.gsub(/[aeiou]/, '*')
  end
  def +(other)
    Bowdlerize.new(self.to_s + other.to_s)
  end
  def to_s
    @value
  end
end

a = Bowdlerize.new("damn ") → d*mn
a += "shame"                → d*mn sh*m*

```

Something you won't find in Ruby are the autoincrement (`++`) and autodecrement (`--`) operators of C and Java. Use the `+=` and `-=` forms instead.

Conditional Execution

Ruby has several different mechanisms for conditional execution of code; most of them should feel familiar, and many have some neat twists. Before we get into them, though, we need to spend a short time looking at boolean expressions.

Boolean Expressions

Ruby has a simple definition of truth. Any value that is not `nil` or the constant `false` is true. You'll find that the library routines use this fact consistently. For example, `IO#gets`, which returns the next line from a file, returns `nil` at end of file, enabling you to write loops such as

```
while line = gets
  # process line
end
```

However, C, C++, and Perl programmers sometimes fall into a trap. The number zero is *not* interpreted as a false value. Neither is a zero-length string. This can be a tough habit to break.

Defined?, And, Or, and Not

Ruby supports all the standard boolean operators and introduces the new operator `defined?`.

Both `and` and `&&` evaluate to true only if both operands are true. They evaluate the second operand only if the first is true (this is sometimes known as *shortcircuit* evaluation). The only difference in the two forms is precedence (`and` binds lower than `&&`).

Similarly, both `or` and `||` evaluate to true if either operand is true. They evaluate their second operand only if the first is false. As with `and`, the only difference between `or` and `||` is their precedence.

Just to make life interesting, `and` and `or` have the same precedence, and `&&` has a higher precedence than `||`.

`not` and `!` return the opposite of their operand (false if the operand is true, and true if the operand is false). `And`, `yes`, `not` and `!` differ only in precedence.

All these precedence rules are summarized in Table 22.4 on page 324.

The `defined?` operator returns `nil` if its argument (which can be an arbitrary expression) is not defined; otherwise it returns a description of that argument. If the argument is `yield`, `defined?` returns the string “yield” if a code block is associated with the current context.

```
defined? 1          → "expression"
defined? dummy     → nil
defined? printf    → "method"
defined? String    → "constant"
defined? $_        → "global-variable"
defined? Math::PI  → "constant"
defined? a = 1     → "assignment"
defined? 42.abs    → "method"
```

In addition to the boolean operators, Ruby objects support comparison using the methods `==`, `===`, `<=>`, `=~`, `eql?`, and `equal?` (see Table 7.1 on the next page). All but `<=>` are defined in class `Object` but are often overridden by descendents to provide appropriate semantics. For example, class `Array` redefines `==` so that two array objects are equal if they have the same number of elements and corresponding elements are equal.

Table 7.1. Common comparison operators

Operator	Meaning
<code>==</code>	Test for equal value.
<code>===</code>	Used to compare each of the items with the target in the when clause of a case statement.
<code><=></code>	General comparison operator. Returns <code>-1</code> , <code>0</code> , or <code>+1</code> , depending on whether its receiver is less than, equal to, or greater than its argument.
<code><</code> , <code><=</code> , <code>>=</code> , <code>></code>	Comparison operators for less than, less than or equal, greater than or equal, and greater than.
<code>=~</code>	Regular expression pattern match.
<code>equal?</code>	True if the receiver and argument have both the same type and equal values. <code>1 == 1.0</code> returns <code>true</code> , but <code>1.equal?(1.0)</code> is <code>false</code> .
<code>equal?</code>	True if the receiver and argument have the same object ID.

Both `==` and `=~` have negated forms, `!=` and `!~`. However, these are converted by Ruby when your program is read. `a != b` is equivalent to `!(a == b)`, and `a !~ b` is the same as `!(a =~ b)`. This means that if you write a class that overrides `==` or `=~` you get a working `!=` and `!~` for free. But on the flip side, this also means that you cannot define `!=` and `!~` independent of `==` and `=~`, respectively.

You can use a Ruby range as a boolean expression. A range such as `exp1..exp2` will evaluate as `false` until `exp1` becomes `true`. The range will then evaluate as `true` until `exp2` becomes `true`. Once this happens, the range resets, ready to fire again. We show some examples of this on page 94.

1.8

Prior to Ruby 1.8, you could use a bare regular expression as a boolean expression. This is now deprecated. You can still use the `~` operator (described on page 580) to match `$_` against a pattern.

The Value of Logical Expressions

In the text, we said things such as “and evaluates to true if both operands are true.” But it’s actually slightly more subtle than that. The operators `and`, `or`, `&&` and `||` actually return the first of their arguments that determine the truth or falsity of the condition. Sounds grand. What does it mean?

Take the expression “`val1 and val2`”. If `val1` is either `false` or `nil`, then we know the expression cannot be true. In this case, the value of `val1` determines the overall value of the expression, so it is the value returned. If `val1` has some other value, then the overall value of the expression depends on `val2`, so its value is returned.

```

nil   and true   → nil
false and true   → false
99   and false   → false
99   and nil     → nil
99   and "cat"   → "cat"

```

Note that despite all this magic, the overall truth value of the expression is correct.

The same evaluation takes place for `or` (except an `or` expression's value is known early if `val1` is not false).

```

false or nil     → nil
nil   or false   → false
99    or false   → 99

```

A common Ruby idiom makes use of this.

```

words[key] ||= []
words[key] << word

```

The first line is equivalent to `words[key] = words[key] || []`. If the entry in the hash `words` for `key` is unset (`nil`), the value of `||` will be the second operand, a new, empty array. Thus, this line of code will assign an array to a hash element that doesn't already have a value, leaving it untouched otherwise. You'll sometimes see this written on one line:

```

(words[key] ||= []) << word

```

If and Unless Expressions

An `if` expression in Ruby is pretty similar to “if” statements in other languages.

```

if song.artist == "Gillespie" then
  handle = "Dizzy"
elsif song.artist == "Parker" then
  handle = "Bird"
else
  handle = "unknown"
end

```

If you lay out your `if` statements on multiple lines, you can leave off the `then` keyword.

```

if song.artist == "Gillespie"
  handle = "Dizzy"
elsif song.artist == "Parker"
  handle = "Bird"
else
  handle = "unknown"
end

```

However, if you want to lay out your code more tightly, you can separate the boolean expression from the following statements with the `then` keyword.

```

if song.artist == "Gillespie" then handle = "Dizzy"
elsif song.artist == "Parker" then handle = "Bird"
else handle = "unknown"
end

```

1.8 You can get even terser and use a colon (:) in place of the then.

```

if song.artist == "Gillespie": handle = "Dizzy"
elsif song.artist == "Parker": handle = "Bird"
else handle = "unknown"
end

```

You can have zero or more `elsif` clauses and an optional `else` clause.

As we've said before, `if` is an expression, not a statement—it returns a value. You don't have to use the value of an `if` expression, but it can come in handy.

```

handle = if song.artist == "Gillespie" then
  "Dizzy"
elsif song.artist == "Parker" then
  "Bird"
else
  "unknown"
end

```

Ruby also has a negated form of the `if` statement.

```

unless song.duration > 180
  cost = 0.25
else
  cost = 0.35
end

```

Finally, for the C fans out there, Ruby also supports the C-style conditional expression.

```

cost = song.duration > 180 ? 0.35 : 0.25

```

A conditional expression returns the value of either the expression before or the expression after the colon, depending on whether the boolean expression before the question mark evaluates to `true` or `false`. In this case, if the song duration is greater than three minutes, the expression returns 0.35. For shorter songs, it returns 0.25. Whatever the result, it is then assigned to `cost`.

If and Unless Modifiers

Ruby shares a neat feature with Perl. Statement modifiers let you tack conditional statements onto the end of a normal statement.

```

mon, day, year = $1, $2, $3 if date =~ /\d\d)-(\d\d)-(\d\d)/
puts "a = #{a}" if debug
print total unless total.zero?

```

For an `if` modifier, the preceding expression will be evaluated only if the condition is true. `unless` works the other way around.

```
File.foreach("/etc/fstab") do |line|
  next if line =~ /^#/          # Skip comments
  parse(line) unless line =~ /^$/ # Don't parse empty lines
end
```

Because `if` itself is an expression, you can get really obscure with statements such as

```
if artist == "John Coltrane"
  artist = "'Trane"
end unless use_nicknames == "no"
```

This path leads to the gates of madness.

Case Expressions

The Ruby case expression is a powerful beast: a multiway `if` on steroids. And just to make it even more powerful, it comes in two flavors.

The first form is fairly close to a series of `if` statements: it lets you list a series of conditions and execute a statement corresponding to the first one that's true. For example, leap years must be divisible by 400, or divisible by 4 and not by 100.

```
leap = case
  when year % 400 == 0: true
  when year % 100 == 0: false
  else year % 4 == 0
end
```

The second form of the case statement is probably more common. You specify a target at the top of the case statement, and each `when` clause lists one or more comparisons.

```
case input_line
when "debug"
  dump_debug_info
  dump_symbols
when /p\s+(\w+)/
  dump_variable($1)
when "quit", "exit"
  exit
else
  print "Illegal command: #{input_line}"
end
```

As with `if`, `case` returns the value of the last expression executed, and you can use a `then` keyword if the expression is on the same line as the condition.

```

kind = case year
  when 1850..1889 then "Blues"
  when 1890..1909 then "Ragtime"
  when 1910..1929 then "New Orleans Jazz"
  when 1930..1939 then "Swing"
  when 1940..1950 then "Bebop"
  else
    "Jazz"
  end

```

1.8 As with if statements, you can use a colon (:) in place of the then.

```

kind = case year
  when 1850..1889: "Blues"
  when 1890..1909: "Ragtime"
  when 1910..1929: "New Orleans Jazz"
  when 1930..1939: "Swing"
  when 1940..1950: "Bebop"
  else
    "Jazz"
  end

```

case operates by comparing the target (the expression after the keyword case) with each of the comparison expressions after the when keywords. This test is done using *comparison === target*. As long as a class defines meaningful semantics for === (and all the built-in classes do), objects of that class can be used in case expressions.

For example, regular expressions define === as a simple pattern match.

```

case line
  when /title=(.*)/
    puts "Title is #\$1"
  when /track=(.*)/
    puts "Track is #\$1"
  when /artist=(.*)/
    puts "Artist is #\$1"
  end

```

Ruby classes are instances of class Class, which defines === to test if the argument is an instance of the class or one of its superclasses. So (abandoning the benefits of polymorphism and bringing the gods of refactoring down around your ears), you can test the class of objects.

```

case shape
  when Square, Rectangle
    # ...
  when Circle
    # ...
  when Triangle
    # ...
  else
    # ...
  end

```

Loops

Don't tell anyone, but Ruby has pretty primitive built-in looping constructs.

The `while` loop executes its body zero or more times as long as its condition is true. For example, this common idiom reads until the input is exhausted.

```
while line = gets
  # ...
end
```

The `until` loop is the opposite; it executes the body *until* the condition becomes true.

```
until play_list.duration > 60
  play_list.add(song_list.pop)
end
```

As with `if` and `unless`, you can use both of the loops as statement modifiers.

```
a = 1
a *= 2 while a < 100
a -= 10 until a < 100
a → 98
```

On page 89 in the section on boolean expressions, we said that a range can be used as a kind of flip-flop, returning true when some event happens and then staying true until a second event occurs. This facility is normally used within loops. In the example that follows, we read a text file containing the first ten ordinal numbers (“first,” “second,” and so on) but print only the lines starting with the one that matches “third” and ending with the one that matches “fifth.”

```
file = File.open("ordinal")
while line = file.gets
  puts(line) if line =~ /third/ .. line =~ /fifth/
end
```

produces:

```
third
fourth
fifth
```

You may find folks who come from Perl writing the previously example slightly differently.

```
file = File.open("ordinal")
while file.gets
  print if ~/third/ .. ~/fifth/
end
```

produces:

```
third
fourth
fifth
```

This uses some behind-the-scenes magic behavior: `gets` assigns the last line read to the global variable `$_`, the `~` operator does a regular expression match against `$_`, and `print` with no arguments prints `$_`. This kind of code is falling out of fashion in the Ruby community.

The elements of a range used in a boolean expression can themselves be expressions. These are evaluated each time the overall boolean expression is evaluated. For example, the following code uses the fact that the variable `$.` contains the current input line number to display line numbers one through three and those between a match of `/eig/` and `/nin/`.

```
File.foreach("ordinal") do |line|
  if (($. == 1) || line =~ /eig/) .. (($. == 3) || line =~ /nin/)
    print line
  end
end
```

produces:

```
first
second
third
eighth
ninth
```

You’ll come across a wrinkle when you use `while` and `until` as statement modifiers. If the statement they are modifying is a `begin/end` block, the code in the block will always execute at least one time, regardless of the value of the boolean expression.

```
print "Hello\n" while false
begin
  print "Goodbye\n"
end while false
```

produces:

```
Goodbye
```

Iterators

If you read the beginning of the previous section, you may have been discouraged. “Ruby has pretty primitive built-in looping constructs,” it said. Don’t despair, gentle reader, for we have good news. Ruby doesn’t need any sophisticated built-in loops, because all the fun stuff is implemented using Ruby iterators.

For example, Ruby doesn’t have a “for” loop—at least not the kind you’d find in C, C++, and Java. Instead, Ruby uses methods defined in various built-in classes to provide equivalent, but less error-prone, functionality.

Let’s look at some examples.

```
3.times do
  print "Ho! "
end
```

produces:

```
Ho! Ho! Ho!
```

It's easy to avoid fence-post and off-by-one errors; this loop will execute three times, period. In addition to `times`, integers can loop over specific ranges by calling `downto` and `upto`, and all numbers can loop using `step`. For instance, a traditional “for” loop that runs from 0 to 9 (something like `i=0; i < 10; i++`) is written as follows.

```
0.upto(9) do |x|
  print x, " "
end
```

produces:

```
0 1 2 3 4 5 6 7 8 9
```

A loop from 0 to 12 by 3 can be written as follows.

```
0.step(12, 3) {|x| print x, " " }
```

produces:

```
0 3 6 9 12
```

Similarly, iterating over arrays and other containers is made easy using their `each` method.

```
[ 1, 1, 2, 3, 5 ].each {|val| print val, " " }
```

produces:

```
1 1 2 3 5
```

And once a class supports `each`, the additional methods in the `Enumerable` module (documented beginning on page 433 and summarized on pages 113–113) become available. For example, the `File` class provides an `each` method, which returns each line of a file in turn. Using the `grep` method in `Enumerable`, we could iterate over only those lines that meet a certain condition.

```
File.open("ordinal").grep(/d$/) do |line|
  puts line
end
```

produces:

```
second
third
```

Last, and probably least, is the most basic loop of all. Ruby provides a built-in iterator called `loop`.

```

loop do
  # block ...
end

```

The loop iterator calls the associated block forever (or at least until you break out of the loop, but you'll have to read ahead to find out how to do that).

For ... In

Earlier we said that the only built-in Ruby looping primitives were `while` and `until`. What's this `for` thing, then? Well, `for` is almost a lump of syntactic sugar. When you write

```

for song in songlist
  song.play
end

```

Ruby translates it into something like

```

songlist.each do |song|
  song.play
end

```

The only difference between the `for` loop and the `each` form is the scope of local variables that are defined in the body. This is discussed on page [99](#).

You can use `for` to iterate over any object that responds to the method `each`, such as an Array or a Range.

```

for i in ['fee', 'fi', 'fo', 'fum']
  print i, " "
end
for i in 1..3
  print i, " "
end
for i in File.open("ordinal").find_all {|line| line =~ /d$/}
  print i.chomp, " "
end

```

produces:

```

fee fi fo fum 1 2 3 second third

```

As long as your class defines a sensible `each` method, you can use a `for` loop to traverse its objects.

```

class Periods
  def each
    yield "Classical"
    yield "Jazz"
    yield "Rock"
  end
end

```

```

periods = Periods.new
for genre in periods
  print genre, " "
end

```

produces:

```

Classical Jazz Rock

```

Break, Redo, and Next

The loop control constructs `break`, `redo`, and `next` let you alter the normal flow through a loop or iterator.

`break` terminates the immediately enclosing loop; control resumes at the statement following the block. `redo` repeats the loop from the start, but without reevaluating the condition or fetching the next element (in an iterator). `next` skips to the end of the loop, effectively starting the next iteration.

```

while line = gets
  next if line =~ /\s*/ # skip comments
  break if line =~ /^END/ # stop at end
                        # substitute stuff in backticks and try again
  redo if line.gsub!(/`(.*)`) { eval($1) }
  # process line ...
end

```

These keywords can also be used with any of the iterator-based looping mechanisms.

```

i=0
loop do
  i += 1
  next if i < 3
  print i
  break if i > 4
end

```

produces:

```

345

```

1.8

As of Ruby 1.8, `break` and `next` can be given arguments. When used in conventional loops, it probably makes sense only to do this with `break` (as any value given to `next` is effectively lost). If a conventional loop doesn't execute a `break`, its value is `nil`.

```

result = while line = gets
  break(line) if line =~ /answer/
end

process_answer(result) if result

```

If you want the nitty-gritty detail of how `break` and `next` work with blocks and procs, have a look at the reference description starting on page 343. If you are looking for a

way of exiting from nested blocks or loops, have a look at `Kernel.catch`, described on pages 347 and 498.

Retry

The `redo` statement causes a loop to repeat the current iteration. Sometimes, though, you need to wind the loop right back to the very beginning. The `retry` statement is just the ticket. `retry` restarts any kind of iterator loop.

```
for i in 1..100
  print "Now at #{i}. Restart? "
  retry if gets =~ /^y/i
end
```

Running this interactively, you may see

```
Now at 1. Restart? n
Now at 2. Restart? y
Now at 1. Restart? n
. . .
```

`retry` will reevaluate any arguments to the iterator before restarting it. Here's an example of a do-it-yourself `until` loop.

```
def do_until(cond)
  break if cond
  yield
  retry
end

i = 0
do_until(i > 10) do
  print i, " "
  i += 1
end
```

produces:

```
0 1 2 3 4 5 6 7 8 9 10
```

Variable Scope, Loops, and Blocks

The `while`, `until`, and `for` loops are built into the language and do not introduce new scope; previously existing locals can be used in the loop, and any new locals created will be available afterward.

The blocks used by iterators (such as `loop` and `each`) are a little different. Normally, the local variables created in these blocks are not accessible outside the block.

```
[ 1, 2, 3 ].each do |x|
  y = x + 1
end
[ x, y ]
```

produces:

```
prog.rb:4: undefined local variable or method `x' for
main:Object (NameError)
```

However, if at the time the block executes a local variable already exists with the same name as that of a variable in the block, the existing local variable will be used in the block. Its value will therefore be available after the block finishes. As the following example shows, this applies both to normal variables in the block and to the block's parameters.

```
x = nil
y = nil
[ 1, 2, 3 ].each do |x|
  y = x + 1
end
[ x, y ] → [3, 4]
```

Note that the variable need not have been given a value in the outer scope: the Ruby interpreter just needs to have seen it.

```
if false
  a = 1
end
3.times { |i| a = i }

a → 2
```

The whole issue with variable scope and blocks is one that generates considerable discussion in the Ruby community. The current scheme has definite problems (particularly when variables are unexpectedly aliased inside blocks), but at the same time no one has managed to come up with something that's both better and acceptable to the wider community. Matz is promising changes in Ruby 2.0, but in the meantime, we have a couple of suggestions to minimize the problems with local and block variables interfering.

- Keep your methods and blocks short. The fewer variables, the smaller the chance that they'll clobber each other. It's also easier to eyeball the code and check that you don't have conflicting names.
- Use different naming schemes for local variables and block parameters. For example, you probably don't want a local variable called "i," but that might be perfectly acceptable as a block parameter.

In reality, this problem doesn't arise in practice as often as you may think.

Exceptions, Catch, and Throw

So far we've been developing code in Pleasantville, a wonderful place where nothing ever, ever goes wrong. Every library call succeeds, users never enter incorrect data, and resources are plentiful and cheap. Well, that's about to change. Welcome to the real world!

In the real world, errors happen. Good programs (and programmers) anticipate them and arrange to handle them gracefully. This isn't always as easy as it may sound. Often the code that detects an error does not have the context to know what to do about it. For example, attempting to open a file that doesn't exist is acceptable in some circumstances and is a fatal error at other times. What's your file-handling module to do?

The traditional approach is to use return codes. The `open` method returns some specific value to say it failed. This value is then propagated back through the layers of calling routines until someone wants to take responsibility for it.

The problem with this approach is that managing all these error codes can be a pain. If a function calls `open`, then `read`, and finally `close`, and each can return an error indication, how can the function distinguish these error codes in the value it returns to *its* caller?

To a large extent, exceptions solve this problem. Exceptions let you package information about an error into an object. That exception object is then propagated back up the calling stack automatically until the runtime system finds code that explicitly declares that it knows how to handle that type of exception.

The Exception Class

The package that contains the information about an exception is an object of class `Exception` or one of class `Exception`'s children. Ruby predefines a tidy hierarchy of

exceptions, shown in Figure 8.1 on the next page. As we'll see later, this hierarchy makes handling exceptions considerably easier.

When you need to raise an exception, you can use one of the built-in Exception classes, or you can create one of your own. If you create your own, you may want to make it a subclass of StandardError or one of its children. If you don't, your exception won't be caught by default.

Every Exception has associated with it a message string and a stack backtrace. If you define your own exceptions, you can add additional information.

Handling Exceptions

Our jukebox downloads songs from the Internet using a TCP socket. The basic code is simple (assuming that the filename and the socket are already set up).

```
op_file = File.open(opfile_name, "w")
while data = socket.read(512)
  op_file.write(data)
end
```

What happens if we get a fatal error halfway through the download? We certainly don't want to store an incomplete song in the song list. "I Did It My **click**."

Let's add some exception-handling code and see how it helps. To do exception handling, we enclose the code that could raise an exception in a begin/end block and use one or more rescue clauses to tell Ruby the types of exceptions we want to handle. In this particular case we're interested in trapping SystemCallError exceptions (and, by implication, any exceptions that are subclasses of SystemCallError), so that's what appears on the rescue line. In the error-handling block, we report the error, close and delete the output file, and then reraise the exception.

```
op_file = File.open(opfile_name, "w")
begin
  # Exceptions raised by this code will
  # be caught by the following rescue clause
  while data = socket.read(512)
    op_file.write(data)
  end
rescue SystemCallError
  $stderr.print "IO failed: " + $!
  op_file.close
  File.delete(opfile_name)
  raise
end
```

When an exception is raised, and independent of any subsequent exception handling, Ruby places a reference to the associated Exception object into the global variable \$!

Figure 8.1. Ruby exception hierarchy

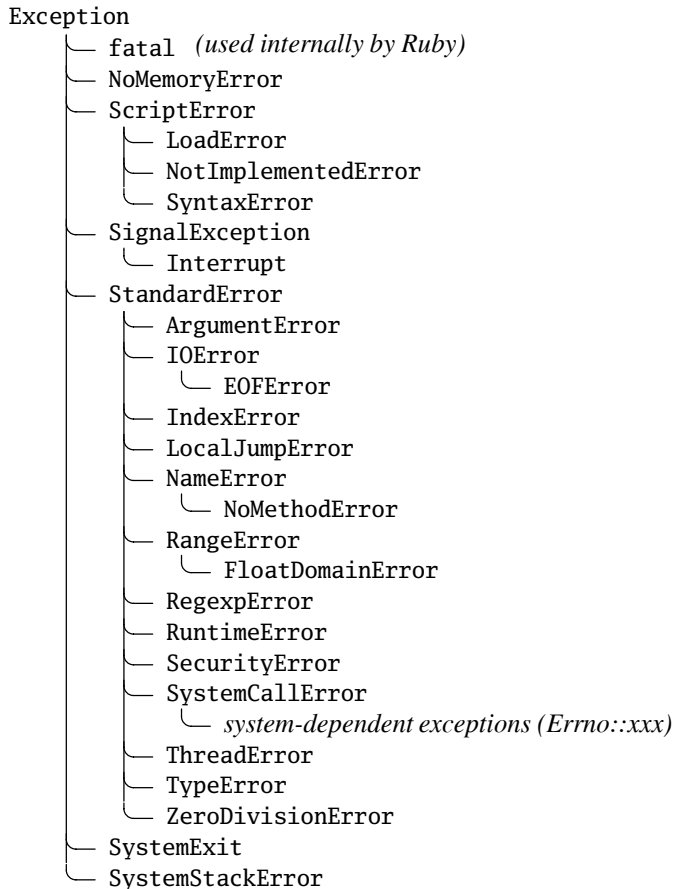

(the exclamation point presumably mirroring our surprise that any of *our* code could cause errors). In the previous example, we used the `#!` variable to format our error message.

After closing and deleting the file, we call `raise` with no parameters, which reraises the exception in `#!`. This is a useful technique, as it allows you to write code that filters exceptions, passing on those you can't handle to higher levels. It's almost like implementing an inheritance hierarchy for error processing.

You can have multiple `rescue` clauses in a `begin` block, and each `rescue` clause can specify multiple exceptions to catch. At the end of each `rescue` clause you can give

Ruby the name of a local variable to receive the matched exception. Many people find this more readable than using `$!` all over the place.

```
begin
  eval string
rescue SyntaxError, NameError => boom
  print "String doesn't compile: " + boom
rescue StandardError => bang
  print "Error running script: " + bang
end
```

1.8

How does Ruby decide which `rescue` clause to execute? It turns out that the processing is pretty similar to that used by the `case` statement. For each `rescue` clause in the `begin` block, Ruby compares the raised exception against each of the parameters in turn. If the raised exception matches a parameter, Ruby executes the body of the `rescue` and stops looking. The match is made using `parameter===$!`. For most exceptions, this means that the match will succeed if the exception named in the `rescue` clause is the same as the type of the currently thrown exception, or is a superclass of that exception.¹ If you write a `rescue` clause with no parameter list, the parameter defaults to `StandardError`.

If no `rescue` clause matches, or if an exception is raised outside a `begin/end` block, Ruby moves up the stack and looks for an exception handler in the caller, then in the caller's caller, and so on.

Although the parameters to the `rescue` clause are typically the names of `Exception` classes, they can actually be arbitrary expressions (including method calls) that return an `Exception` class.

1.8 System Errors

System errors are raised when a call to the operating system returns an error code. On POSIX systems, these errors have names such as `EAGAIN` and `EPERM`. (If you're on a Unix box, you could type `man errno` to get a list of these errors.)

Ruby takes these errors and wraps them each in a specific exception object. Each is a subclass of `SystemCallError`, and each is defined in a module called `Errno`. This means you'll find exceptions with class names such as `Errno::EAGAIN`, `Errno::EIO`, and `Errno::EPERM`. If you want to get to the underlying system error code, `Errno` exception objects each have a class constant called (somewhat confusingly) `Errno` that contains the value.

1. This comparison happens because exceptions are classes, and classes in turn are kinds of `Module`. The `===` method is defined for modules, returning `true` if the class of the operand is the same as or an ancestor of the receiver.

```

Errno::EAGAIN::Errno    → 35
Errno::EPERM::Errno    → 1
Errno::EIO::Errno      → 5
Errno::EWOULDBLOCK::Errno → 35

```

Note that `EWOULDBLOCK` and `EAGAIN` have the same error number. This is a feature of the operating system of the computer used to produce this book—the two constants map to the same error number. To deal with this, Ruby arranges things so that `Errno::EAGAIN` and `Errno::EWOULDBLOCK` are treated identically in a `rescue` clause. If you ask to `rescue` one, you'll `rescue` either. It does this by redefining `SystemCallError#===` so that if two subclasses of `SystemCallError` are compared, the comparison is done on their error number and not on their position in the hierarchy.

Tidying Up

Sometimes you need to guarantee that some processing is done at the end of a block of code, regardless of whether an exception was raised. For example, you may have a file open on entry to the block, and you need to make sure it gets closed as the block exits.

The `ensure` clause does just this. `ensure` goes after the last `rescue` clause and contains a chunk of code that will always be executed as the block terminates. It doesn't matter if the block exits normally, if it raises and `rescues` an exception, or if it is terminated by an uncaught exception—the `ensure` block will get run.

```

f = File.open("testfile")
begin
  # .. process
rescue
  # .. handle error
ensure
  f.close unless f.nil?
end

```

The `else` clause is a similar, although less useful, construct. If present, it goes after the `rescue` clauses and before any `ensure`. The body of an `else` clause is executed only if no exceptions are raised by the main body of code.

```

f = File.open("testfile")
begin
  # .. process
rescue
  # .. handle error
else
  puts "Congratulations-- no errors!"
ensure
  f.close unless f.nil?
end

```

Play It Again

Sometimes you may be able to correct the cause of an exception. In those cases, you can use the `retry` statement within a `rescue` clause to repeat the entire `begin/end` block. Clearly, tremendous scope exists for infinite loops here, so this is a feature to use with caution (and with a finger resting lightly on the interrupt key).

As an example of code that retries on exceptions, have a look at the following, adapted from Minero Aoki's `net/smtp.rb` library.

```
@esmtplib = true
begin
  # First try an extended login. If it fails because the
  # server doesn't support it, fall back to a normal login
  if @esmtplib then
    @command.ehlo(helodom)
  else
    @command.helo(helodom)
  end
rescue ProtocolError
  if @esmtplib then
    @esmtplib = false
    retry
  else
    raise
  end
end
```

This code tries first to connect to an SMTP server using the EHL0 command, which is not universally supported. If the connection attempt fails, the code sets the `@esmtplib` variable to `false` and retries the connection. If this fails a second time, the exception is raised up to the caller.

Raising Exceptions

So far we've been on the defensive, handling exceptions raised by others. It's time to turn the tables and go on the offensive. (Some say your gentle authors are always offensive, but that's a different book.)

You can raise exceptions in your code with the `Kernel.raise` method (or its somewhat judgmental synonym, `Kernel.fail`).

```
raise
raise "bad mp3 encoding"
raise InterfaceException, "Keyboard failure", caller
```

The first form simply reraises the current exception (or a `RuntimeError` if there is no current exception). This is used in exception handlers that need to intercept an exception before passing it on.

The second form creates a new `RuntimeError` exception, setting its message to the given string. This exception is then raised up the call stack.

The third form uses the first argument to create an exception and then sets the associated message to the second argument and the stack trace to the third argument. Typically the first argument will be either the name of a class in the `Exception` hierarchy or a reference to an object instance of one of these classes.² The stack trace is normally produced using the `Kernel.caller` method.

Here are some typical examples of `raise` in action.

```
raise
raise "Missing name" if name.nil?
if i >= names.size
  raise IndexError, "#{i} >= size (#{names.size})"
end
raise ArgumentError, "Name too big", caller
```

In the last example, we remove the current routine from the stack backtrace, which is often useful in library modules. We can take this further: the following code removes two routines from the backtrace by passing only a subset of the call stack to the new exception.

```
raise ArgumentError, "Name too big", caller[1..-1]
```

Adding Information to Exceptions

You can define your own exceptions to hold any information that you need to pass out from the site of an error. For example, certain types of network errors may be transient depending on the circumstances. If such an error occurs, and the circumstances are right, you could set a flag in the exception to tell the handler that it may be worth retrying the operation.

```
class RetryException < RuntimeError
  attr :ok_to_retry
  def initialize(ok_to_retry)
    @ok_to_retry = ok_to_retry
  end
end
```

2. Technically, this argument can be any object that responds to the message `exception?` by returning an object such that `object.kind_of?(Exception)` is true.

Somewhere down in the depths of the code, a transient error occurs.

```
def read_data(socket)
  data = socket.read(512)
  if data.nil?
    raise RetryException.new(true), "transient read error"
  end
  # .. normal processing
end
```

Higher up the call stack, we handle the exception.

```
begin
  stuff = read_data(socket)
  # .. process stuff
rescue RetryException => detail
  retry if detail.ok_to_retry
  raise
end
```

Catch and Throw

While the exception mechanism of `raise` and `rescue` is great for abandoning execution when things go wrong, it's sometimes nice to be able to jump out of some deeply nested construct during normal processing. This is where `catch` and `throw` come in handy.

```
catch (:done) do
  while line = gets
    throw :done unless fields = line.split(/\t/)
    songlist.add(Song.new(*fields))
  end
  songlist.play
end
```

`catch` defines a block that is labeled with the given name (which may be a `Symbol` or a `String`). The block is executed normally until a `throw` is encountered.

When Ruby encounters a `throw`, it zips back up the call stack looking for a `catch` block with a matching symbol. When it finds it, Ruby unwinds the stack to that point and terminates the block. So, in the previous example, if the input does not contain correctly formatted lines, the `throw` will skip to the end of the corresponding `catch`, not only terminating the `while` loop but also skipping the playing of the song list. If the `throw` is called with the optional second parameter, that value is returned as the value of the `catch`.

The following example uses a `throw` to terminate interaction with the user if `!` is typed in response to any prompt.

```
def prompt_and_get(prompt)
  print prompt
  res = readline.chomp
  throw :quit_requested if res == "!"
  res
end
catch :quit_requested do
  name = prompt_and_get("Name: ")
  age  = prompt_and_get("Age: ")
  sex  = prompt_and_get("Sex: ")
  # ..
  # process information
end
```

As this example illustrates, the `throw` does not have to appear within the static scope of the `catch`.

Modules

Modules are a way of grouping together methods, classes, and constants. Modules give you two major benefits.

1. Modules provide a namespace and prevent name clashes.
2. Modules implement the mixin facility.

Namespaces

As you start to write bigger and bigger Ruby programs, you'll naturally find yourself producing chunks of reusable code—libraries of related routines that are generally applicable. You'll want to break this code into separate files so the contents can be shared among different Ruby programs.

Often this code will be organized into classes, so you'll probably stick a class (or a set of interrelated classes) into a file.

However, there are times when you want to group things together that don't naturally form a class.

An initial approach may be to put all these things into a file and simply load that file into any program that needs it. This is the way the C language works. However, this approach has a problem. Say you write a set of the trigonometry functions `sin`, `cos`, and so on. You stuff them all into a file, `trig.rb`, for future generations to enjoy. Meanwhile, Sally is working on a simulation of good and evil, and she codes a set of her own useful routines, including `be_good` and `sin`, and sticks them into `moral.rb`. Joe, who wants to write a program to find out how many angels can dance on the head of a pin, needs to load both `trig.rb` and `moral.rb` into his program. But both define a method called `sin`. Bad news.

The answer is the module mechanism. Modules define a *namespace*, a sandbox in which your methods and constants can play without having to worry about being stepped on by other methods and constants. The trig functions can go into one module

```
module Trig
  PI = 3.141592654
  def Trig.sin(x)
    # ..
  end
  def Trig.cos(x)
    # ..
  end
end
```

and the good and bad “moral” methods can go into another.

```
module Moral
  VERY_BAD = 0
  BAD      = 1
  def Moral.sin(badness)
    # ...
  end
end
```

Module constants are named just like class constants, with an initial uppercase letter. The method definitions look similar, too: these module methods are defined just like class methods.

If a third program wants to use these modules, it can simply load the two files (using the Ruby `require` statement, which we discuss on page 116) and reference the qualified names.

```
require 'trig'
require 'moral'
y = Trig.sin(Trig::PI/4)
wrongdoing = Moral.sin(Moral::VERY_BAD)
```

As with class methods, you call a module method by preceding its name with the module’s name and a period, and you reference a constant using the module name and two colons.

Mixins

Modules have another, wonderful use. At a stroke, they pretty much eliminate the need for multiple inheritance, providing a facility called a *mixin*.

In the previous section’s examples, we defined module methods, methods whose names were prefixed by the module name. If this made you think of class methods, your next thought may well be “what happens if I define instance methods within a module?”

Good question. A module can't have instances, because a module isn't a class. However, you can *include* a module within a class definition. When this happens, all the module's instance methods are suddenly available as methods in the class as well. They get *mixed in*. In fact, mixed-in modules effectively behave as superclasses.

```

module Debug
  def who_am_i?
    "#{self.class.name} (\##{self.id}): #{self.to_s}"
  end
end

class Phonograph
  include Debug
  # ...
end

class EightTrack
  include Debug
  # ...
end

ph = Phonograph.new("West End Blues")
et = EightTrack.new("Surrealistic Pillow")

ph.who_am_i?  → "Phonograph (#935520): West End Blues"
et.who_am_i?  → "EightTrack (#935500): Surrealistic Pillow"

```

By including the `Debug` module, both `Phonograph` and `EightTrack` gain access to the `who_am_i?` instance method.

We'll make a couple of points about the `include` statement before we go on. First, it has nothing to do with files. C programmers use a preprocessor directive called `#include` to insert the contents of one file into another during compilation. The Ruby `include` statement simply makes a reference to a named module. If that module is in a separate file, you must use `require` (or its less commonly used cousin, `load`) to drag that file in before using `include`. Second, a Ruby `include` does not simply copy the module's instance methods into the class. Instead, it makes a reference from the class to the included module. If multiple classes include that module, they'll all point to the same thing. If you change the definition of a method within a module, even while your program is running, all classes that include that module will exhibit the new behavior.¹

Mixins give you a wonderfully controlled way of adding functionality to classes. However, their true power comes out when the code in the mixin starts to interact with code in the class that uses it. Let's take the standard Ruby mixin `Comparable` as an example. You can use the `Comparable` mixin to add the comparison operators (`<`, `<=`, `==`, `>=`, and `>`), as well as the method `between?`, to a class. For this to work, `Comparable` assumes that any class that uses it defines the operator `<=>`. So, as a class writer, you define one method, `<=>`, include `Comparable`, and get six comparison functions for free. Let's

1. Of course, we're speaking only of methods here. Instance variables are always per object, for example.

try this with our `Song` class, by making the songs comparable based on their duration. All we have to do is include the `Comparable` module and implement the comparison operator `<=>`.

```
class Song
  include Comparable
  def initialize(name, artist, duration)
    @name      = name
    @artist    = artist
    @duration  = duration
  end
  def <=>(other)
    self.duration <=> other.duration
  end
end
```

We can check that the results are sensible with a few test songs.

```
song1 = Song.new("My Way", "Sinatra", 225)
song2 = Song.new("Bicylops", "Fleck", 260)

song1 <=> song2 → -1
song1 < song2 → true
song1 == song1 → true
song1 > song2 → false
```

Iterators and the Enumerable Module

You’ve probably noticed that the Ruby collection classes support a large number of operations that do various things with the collection: traverse it, sort it, and so on. You may be thinking, “Gee, it’d sure be nice if *my* class could support all these neat-o features, too!” (If you actually thought that, it’s probably time to stop watching reruns of 1960s television shows.)

Well, your classes *can* support all these neat-o features, thanks to the magic of mixins and module `Enumerable`. All you have to do is write an iterator called `each`, which returns the elements of your collection in turn. Mix in `Enumerable`, and suddenly your class supports things such as `map`, `include?`, and `find_all?`. If the objects in your collection implement meaningful ordering semantics using the `<=>` method, you’ll also get methods such as `min`, `max`, and `sort`.

Composing Modules

Back on page 49 we discussed the `inject` method of `Enumerable`. `Enumerable` is another standard mixin, implementing a bunch of methods in terms of the host class’s

each method. Because of this, we can use `inject` in any class that includes the `Enumerable` module and defines the method `each`. Many built-in classes do this.

```
[ 1, 2, 3, 4, 5 ].inject {|v,n| v+n } → 15
('a'..'m').inject {|v,n| v+n }      → "abcdefghijklm"
```

We could also define our own class that mixes in `Enumerable` and hence gets `inject` support.

```
class VowelFinder
  include Enumerable
  def initialize(string)
    @string = string
  end
  def each
    @string.scan(/[aeiou]/) do |vowel|
      yield vowel
    end
  end
end

vf = VowelFinder.new("the quick brown fox jumped")

vf.inject {|v,n| v+n } → "euiooue"
```

Notice that we've used the same pattern in the call to `inject` in these examples—we're using it to perform a summation. When applied to numbers, it returns the arithmetic sum, when applied to strings it concatenates them. We can use a module to encapsulate this functionality too.

```
module Summable
  def sum
    inject {|v,n| v+n }
  end
end

class Array
  include Summable
end

class Range
  include Summable
end

class VowelFinder
  include Summable
end

[ 1, 2, 3, 4, 5 ].sum → 15
('a'..'m').sum      → "abcdefghijklm"

vf = VowelFinder.new("the quick brown fox jumped")
vf.sum → "euiooue"
```

Instance Variables in Mixins

People coming to Ruby from C++ often ask us, “What happens to instance variables in a mixin? In C++, I have to jump through some hoops to control how variables are shared in a multiple-inheritance hierarchy. How does Ruby handle this?”

Well, for starters, it’s not really a fair question, we tell them. Remember how instance variables work in Ruby: the first mention of an @-prefixed variable creates the instance variable *in the current object*, `self`.

For a mixin, this means that the module you mix into your client class (the *mixee*?) may create instance variables in the client object and may use `attr_reader` and `friends` to define accessors for these instance variables. For instance, the `Observable` module in the following example adds an instance variable `@observer_list` to any class that includes it.

```
module Observable
  def observers
    @observer_list ||= []
  end
  def add_observer(obj)
    observers << obj
  end
  def notify_observers
    observers.each {|o| o.update }
  end
end
```

However, this behavior exposes us to a risk. A mixin’s instance variables can clash with those of the host class or with those of other mixins. The example that follows shows a class that uses our `Observable` module but that unluckily also uses an instance variable called `@observer_list`. At runtime, this program will go wrong in some hard-to-diagnose ways.

```
class TelescopeScheduler
  # other classes can register to get notifications
  # when the schedule changes
  include Observable
  def initialize
    @observer_list = [] # folks with telescope time
  end
  def add_viewer(viewer)
    @observer_list << viewer
  end
  # ...
end
```

For the most part, mixin modules don’t try to carry their own instance data around—they use accessors to retrieve data from the client object. But if you need to create

a mixin that has to have its own state, ensure that the instance variables have unique names to distinguish them from any other mixins in the system (perhaps by using the module's name as part of the variable name). Alternatively, the module could use a module-level hash, indexed by the current object ID, to store instance-specific data without using Ruby instance variables.

```

module Test
  State = {}
  def state=(value)
    State[id] = value
  end
  def state
    State[id]
  end
end

class Client
  include Test
end

c1 = Client.new
c2 = Client.new
c1.state = 'cat'
c2.state = 'dog'

c1.state → "cat"
c2.state → "dog"

```

Resolving Ambiguous Method Names

One of the other questions folks ask about mixins is, how is method lookup handled? In particular, what happens if methods with the same name are defined in a class, in that class's parent class, and in a mixin included into the class?

The answer is that Ruby looks first in the immediate class of an object, then in the mixins included into that class, and then in superclasses and their mixins. If a class has multiple modules mixed in, the last one included is searched first.

Including Other Files

Because Ruby makes it easy to write good, modular code, you'll often find yourself producing small files containing some chunk of self-contained functionality—an interface to *x*, an algorithm to do *y*, and so on. Typically, you'll organize these files as class or module libraries.

Having produced these files, you'll want to incorporate them into your new programs. Ruby has two statements that do this. The `load` method includes the named Ruby source file every time the method is executed.

```
load 'filename.rb'
```

The more commonly used `require` method loads any given file only once.²

```
require 'filename'
```

Local variables in a loaded or required file are not propagated to the scope that loads or requires them. For example, here's a file called `included.rb`.

```
a = 1
def b
  2
end
```

And here's what happens when we include it into another file.

```
a = "cat"
b = "dog"
require 'included'
a → "cat"
b → "dog"
b() → 2
```

`require` has additional functionality: it can load shared binary libraries. Both routines accept relative and absolute paths. If given a relative path (or just a plain name), they'll search every directory in the current load path (`$:`, discussed on page 173) for the file.

Files loaded using `load` or `require` can, of course, include other files, which include other files, and so on. What may *not* be obvious is that `require` is an executable statement—it may be inside an `if` statement, or it may include a string that was just built. The search path can be altered at runtime as well. Just add the directory you want to the array `$:`.

Since `load` will include the source unconditionally, you can use it to reload a source file that may have changed since the program began. The example that follows is (very) contrived.

2. This is not strictly true. Ruby keeps a list of the files loaded by `require` in the array `$`. However, this list contains just the names of files as given to `require`. It's possible to fake Ruby out and get the same file loaded twice.

```
require '/usr/lib/ruby/1.9/English.rb'
require '/usr/lib/ruby/1.9/rdoc/./English.rb'
```

```
$ → ["/usr/lib/ruby/1.9/English.rb", "/usr/lib/ruby/1.9/rdoc/./English.rb"]
```

In this case, both `require` statements ended up pointing at the same file but used different paths to load it. Some consider this a bug, and this behavior may well change in later releases.

```
5.times do |i|
  File.open("temp.rb","w") do |f|
    f.puts "module Temp"
    f.puts "  def Temp.var"
    f.puts "    #{i}"
    f.puts "  end"
    f.puts "end"
  end
  load "temp.rb"
  puts Temp.var
end
```

produces:

```
0
1
2
3
4
```

For a less contrived use of this facility, consider a Web application that reloads components while running. This allows it to update itself on the fly; it needn't be restarted for new version of the software to be integrated. This is one of the many benefits of using a dynamic language such as Ruby.

Basic Input and Output

Ruby provides what at first sight looks like two separate sets of I/O routines. The first is the simple interface—we’ve been using it pretty much exclusively so far.

```
print "Enter your name: "  
name = gets
```

A whole set of I/O-related methods is implemented in the `Kernel` module—`gets`, `open`, `print`, `printf`, `putc`, `puts`, `readline`, `readlines`, and `test`—that makes it simple and convenient to write straightforward Ruby programs. These methods typically do I/O to standard input and standard output, which makes them useful for writing filters. You’ll find them documented starting on page [495](#).

The second way, which gives you a lot more control, is to use IO objects.

What Is an IO Object?

Ruby defines a single base class, `IO`, to handle input and output. This base class is subclassed by classes `File` and `BasicSocket` to provide more specialized behavior, but the principles are the same. An IO object is a bidirectional channel between a Ruby program and some external resource.¹ An IO object may have more to it than meets the eye, but in the end you still simply write to it and read from it.

In this chapter, we’ll be concentrating on class `IO` and its most commonly used subclass, class `File`. For more details on using the socket classes for networking, see the section beginning on page [740](#).

1. For those who just have to know the implementation details, this means that a single IO object can sometimes be managing more than one operating system file descriptor. For example, if you open a pair of pipes, a single IO object contains both a read pipe and a write pipe.

Opening and Closing Files

As you may expect, you can create a new file object using `File.new`.

```
file = File.new("testfile", "r")
# ... process the file
file.close
```

You can create a `File` object that is open for reading, writing, or both, according to the mode string. (Here we opened `testfile` for reading with an `"r"`. We could also have used `"w"` for write or `"rw"` for read-write. The full list of allowed modes appears on page 483.) You can also optionally specify file permissions when creating a file; see the description of `File.new` on page 449 for details. After opening the file, we can work with it, writing and/or reading data as needed. Finally, as responsible software citizens, we close the file, ensuring that all buffered data is written and that all related resources are freed.

But here Ruby can make life a little bit easier for you. The method `File.open` also opens a file. In regular use, it behaves just like `File.new`. However, if a block is associated with the call, `open` behaves differently. Instead of returning a new `File` object, it invokes the block, passing the newly opened `File` as a parameter. When the block exits, the file is automatically closed.

```
File.open("testfile", "r") do |file|
  # ... process the file
end
```

This second approach has an added benefit. In the earlier case, if an exception is raised while processing the file, the call to `file.close` may not happen. Once the file variable goes out of scope, then garbage collection will eventually close it, but this may not happen for a while. Meanwhile, resources are being held open.

This doesn't happen with the block form of `File.open`. If an exception is raised inside the block, the file is closed before the exception is propagated on to the caller. It's as if the `open` method looks like the following.

```
class File
  def File.open(*args)
    result = f = File.new(*args)
    if block_given?
      begin
        result = yield f
      ensure
        f.close
      end
    end
    return result
  end
end
```

Reading and Writing Files

The same methods that we've been using for "simple" I/O are available for all file objects. So, `gets` reads a line from standard input (or from any files specified on the command line when the script was invoked), and `file.gets` reads a line from the file object *file*.

For example, we could create a program called `copy.rb`.

```
while line = gets
  puts line
end
```

If we run this program with no arguments, it will read lines from the console and copy them back to the console. Note that each line is echoed once the return key is pressed. (In this and later examples, we show user input in a bold font.)

```
% ruby copy.rb
These are lines
These are lines
that I am typing
that I am typing
^D
```

We can also pass in one or more filenames on the command line, in which case `gets` will read from each in turn.

```
% ruby copy.rb testfile
This is line one
This is line two
This is line three
And so on...
```

Finally, we can explicitly open the file and read from it.

```
File.open("testfile") do |file|
  while line = file.gets
    puts line
  end
end
```

produces:

```
This is line one
This is line two
This is line three
And so on...
```

As well as `gets`, I/O objects enjoy an additional set of access methods, all intended to make our lives easier.

Iterators for Reading

As well as using the usual loops to read data from an IO stream, you can also use various Ruby iterators. `IO#each_byte` invokes a block with the next 8-bit byte from the IO object (in this case, an object of type `File`).

```
File.open("testfile") do |file|
  file.each_byte {|ch| puts ch; print "." }
end
```

produces:

```
T.h.i.s. .i.s. .l.i.n.e. .o.n.e.
.T.h.i.s. .i.s. .l.i.n.e. .t.w.o.
.T.h.i.s. .i.s. .l.i.n.e. .t.h.r.e.e.
.A.n.d. .s.o. .o.n.....
.
```

`IO#each_line` calls the block with each line from the file. In the next example, we'll make the original newlines visible using `String#dump`, so you can see that we're not cheating.

```
File.open("testfile") do |file|
  file.each_line {|line| puts "Got #{line.dump}" }
end
```

produces:

```
Got "This is line one\n"
Got "This is line two\n"
Got "This is line three\n"
Got "And so on...\n"
```

You can pass `each_line` any sequence of characters as a line separator, and it will break up the input accordingly, returning the line ending at the end of each line of data. That's why you see the `\n` characters in the output of the previous example. In the next example, we'll use the character `e` as the line separator.

```
File.open("testfile") do |file|
  file.each_line("e") {|line| puts "Got #{ line.dump }" }
end
```

produces:

```
Got "This is line"
Got " one"
Got "\nThis is line"
Got " two\nThis is line"
Got " thre"
Got "e"
Got "\nAnd so on...\n"
```

If you combine the idea of an iterator with the autoclosing block feature, you get `IO.foreach`. This method takes the name of an I/O source, opens it for reading, calls the iterator once for every line in the file, and then closes the file automatically.

```
IO.foreach("testfile") {|line| puts line }
```

produces:

```
This is line one
This is line two
This is line three
And so on...
```

Or, if you prefer, you can retrieve an entire file into a string or into an array of lines.

```
# read into string
str = IO.read("testfile")
str.length  → 66
str[0, 30]  → "This is line one\nThis is line "

# read into an array
arr = IO.readlines("testfile")
arr.length  → 4
arr[0]     → "This is line one\n"
```

Don't forget that I/O is never certain in an uncertain world—exceptions will be raised on most errors, and you should be ready to rescue them and take appropriate action.

Writing to Files

So far, we've been merrily calling `puts` and `print`, passing in any old object and trusting that Ruby will do the right thing (which, of course, it does). But what exactly *is* it doing?

The answer is pretty simple. With a couple of exceptions, every object you pass to `puts` and `print` is converted to a string by calling that object's `to_s` method. If for some reason the `to_s` method doesn't return a valid string, a string is created containing the object's class name and ID, something like `#<ClassName:0x123456>`.

The exceptions are simple, too. The `nil` object will print as the string "nil," and an array passed to `puts` will be written as if each of its elements in turn were passed separately to `puts`.

What if you want to write binary data and don't want Ruby messing with it? Well, normally you can simply use `IO#print` and pass in a string containing the bytes to be written. However, you can get at the low-level input and output routines if you really want—look at the documentation for `IO#sysread` and `IO#syswrite` on page 493.

And how do you get the binary data into a string in the first place? The three common ways are to use a literal, poke it in byte by byte, or use `Array#pack`.

```

str1 = "\001\002\003" → "\001\002\003"
str2 = ""
str2 << 1 << 2 << 3 → "\001\002\003"
[ 1, 2, 3 ].pack("c*") → "\001\002\003"

```

But I Miss My C++ iostream

Sometimes there's just no accounting for taste... However, just as you can append an object to an Array using the << operator, you can also append an object to an output IO stream.

```

endl = "\n"
STDOUT << 99 << " red balloons" << endl

```

produces:

```

99 red balloons

```

Again, the << method uses `to_s` to convert its arguments to strings before sending them on their merry way.

Although we started off disparaging the poor << operator, there are actually some good reasons for using it. Because other classes (such as `String` and `Array`) also implement a << operator with similar semantics, you can quite often write code that appends to something using << without caring whether it is added to an array, a file, or a string. This kind of flexibility also makes unit testing easy. We discuss this idea in greater detail in the chapter on duck typing, starting on page 349.

1.8 Doing I/O with Strings

There are often times where you need to work with code that assumes it's reading from or writing to one or more files. But you have a problem: the data isn't in files. Perhaps it's available instead via a SOAP service, or it has been passed to you as command-line parameters. Or maybe you're running unit tests, and you don't want to alter the real file system.

Enter `StringIO` objects. They behave just like other I/O objects, but they read and write strings, not files. If you open a `StringIO` object for reading, you supply it with a string. All read operations on the `StringIO` object then read from this string. Similarly, when you want to write to a `StringIO` object, you pass it a string to be filled.

```

require 'stringio'

ip = StringIO.new("now is\nthe time\nto learn\nRuby!")
op = StringIO.new("", "w")

ip.each_line do |line|
  op.puts line.reverse
end
op.string → "\nsi won\n\nemit eht\n\nrael ot\n!ybuR\n"

```

Talking to Networks

Ruby is fluent in most of the Internet’s protocols, both low-level and high-level.

For those who enjoy groveling around at the network level, Ruby comes with a set of classes in the socket library (documented starting on page 740). These classes give you access to TCP, UDP, SOCKS, and Unix domain sockets, as well as any additional socket types supported on your architecture. The library also provides helper classes to make writing servers easier. Here’s a simple program that gets information about the “mysql” user on our local machine using the finger protocol.

```
require 'socket'
client = TCPSocket.open('127.0.0.1', 'finger')
client.send("mysql\n", 0) # 0 means standard packet
puts client.readlines
client.close
```

produces:

```
Login: mysql           Name: MySQL Server
Directory: /var/empty   Shell: /usr/bin/false
Never logged in.
No Mail.
No Plan.
```

At a higher level, the `lib/net` set of library modules provides handlers for a set of application-level protocols (currently FTP, HTTP, POP, SMTP, and telnet). These are documented starting on page 677. For example, the following program lists the images that are displayed on the Pragmatic Programmer home page.

```
require 'net/http'
h = Net::HTTP.new('www.pragmaticprogrammer.com', 80)
response = h.get('/index.html', nil)
if response.message == "OK"
  puts response.body.scan(/1</sup> exists in this code, but we haven't talked about synchronization yet, so we'll just quietly ignore it for now.)

---

1. A race condition occurs when two or more pieces of code (or hardware) both try to access some shared resource, and where the outcome changes depending on the order in which they do so. In the example here, it is possible for one thread to set the value of its `mycount` variable to `count`, but before it gets a chance to increment `count`, the thread gets descheduled and another thread reuses the same value of `count`. These issues are fixed by synchronizing the access to shared resources (such as the `count` variable).

```

count = 0
threads = []
10.times do |i|
 threads[i] = Thread.new do
 sleep(rand(0.1))
 Thread.current["mycount"] = count
 count += 1
 end
end
threads.each {|t| t.join; print t["mycount"], ", " }
puts "count = #{count}"

```

*produces:*

```
4, 1, 0, 8, 7, 9, 5, 6, 3, 2, count = 10
```

The main thread waits for the subthreads to finish and then prints out the value of `count` captured by each. Just to make it more interesting, we have each thread wait a random time before recording the value.

## Threads and Exceptions

What happens if a thread raises an unhandled exception? It depends on the setting of the `abort_on_exception` flag (documented on pages 612 and 615) and on the setting of the interpreter's *debug* flag (described on page 168).

If `abort_on_exception` is `false` and the `debug` flag is not enabled (the default condition), an unhandled exception simply kills the current thread—all the rest continue to run. In fact, you don't even hear about the exception until you issue a `join` on the thread that raised it.

In the following example, thread 2 blows up and fails to produce any output. However, you can still see the trace from the other threads.

```

threads = []
4.times do |number|
 threads << Thread.new(number) do |i|
 raise "Boom!" if i == 2
 print "#{i}\n"
 end
end
threads.each {|t| t.join }

```

*produces:*

```

0
1
3
prog.rb:4: Boom! (RuntimeError)
from prog.rb:8:in `join'
from prog.rb:8
from prog.rb:8:in `each'
from prog.rb:8

```

We can rescue the exception at the time the threads are joined.

```

threads = []
4.times do |number|
 threads << Thread.new(number) do |i|
 raise "Boom!" if i == 2
 print "#{i}\n"
 end
end
threads.each do |t|
 begin
 t.join
 rescue RuntimeError => e
 puts "Failed: #{e.message}"
 end
end
end

```

*produces:*

```

0
1
3
Failed: Boom!

```

However, set `abort_on_exception` to true, or use `-d` to turn on the debug flag, and an unhandled exception kills all running threads. Once thread 2 dies, no more output is produced.

```

Thread.abort_on_exception = true
threads = []
4.times do |number|
 threads << Thread.new(number) do |i|
 raise "Boom!" if i == 2
 print "#{i}\n"
 end
end
threads.each { |t| t.join }

```

*produces:*

```

0
1
prog.rb:5: Boom! (RuntimeError)
from prog.rb:4:in `initialize'
from prog.rb:4:in `new'
from prog.rb:4
from prog.rb:3:in `times'
from prog.rb:3

```

This code also illustrates a gotcha. Inside the loop, the threads use `print` to write out the number, rather than `puts`. Why? Because behind the scenes, `puts` splits its work into two chunks: it writes its argument, and then it writes a newline. Between these two, a thread could get scheduled, and the output would be interleaved. Calling `print` with a single string that already contains the newline gets around the problem.

## Controlling the Thread Scheduler

In a well-designed application, you'll normally just let threads do their thing; building timing dependencies into a multithreaded application is generally considered to be bad form, as it makes the code far more complex and also prevents the thread scheduler from optimizing the execution of your program.

However, sometimes you need to control threads explicitly. Perhaps the jukebox has a thread that displays a light show. We may need to stop it temporarily when the music stops. You may have two threads in a classic producer-consumer relationship, where the consumer has to pause if the producer gets backlogged.

Class `Thread` provides a number of methods to control the thread scheduler. Invoking `Thread.stop` stops the current thread, and invoking `Thread#run` arranges for a particular thread to be run. `Thread.pass` deschedules the current thread, allowing others to run, and `Thread#join` and `Thread#value` suspend the calling thread until a given thread finishes.

We can demonstrate these features in the following, totally pointless program. It creates two child threads, `t1` and `t2`, each of which runs an instance of class `Chaser`. The `chase` method increments a count but doesn't let it get more than two higher than the count in the other thread. To stop it getting higher, the method issues a `Thread.pass`, which allows the chase in the other thread to catch up. To make it interesting (for some minor definition of *interesting*), we have the threads suspend themselves initially and then start a random one first.

```
class Chaser
 attr_reader :count
 def initialize(name)
 @name = name
 @count = 0
 end
 def chase(other)
 while @count < 5
 while @count - other.count > 1
 Thread.pass
 end
 @count += 1
 print "#@name: #{@count}\n"
 end
 end
end

c1 = Chaser.new("A")
c2 = Chaser.new("B")

threads = [
 Thread.new { Thread.stop; c1.chase(c2) },
 Thread.new { Thread.stop; c2.chase(c1) }
]
```



```

start_index = rand(2)
threads[start_index].run
threads[1 - start_index].run
threads.each {|t| t.join }

```

*produces:*

```

B: 1
B: 2
A: 1
B: 3
A: 2
B: 4
A: 3
B: 5
A: 4
A: 5

```

However, using these primitives to achieve synchronization in real-life code is not easy—race conditions will always be waiting to bite you. And when you’re working with shared data, race conditions pretty much guarantee long and frustrating debugging sessions. In fact, the previous example includes just such a bug; it is possible for `count` to be incremented in one thread, but before that count can be output, the second thread gets scheduled and outputs its count. The resulting output will be out of sequence.

Fortunately, threads have one additional facility—the idea of *mutual exclusion*. Using this, we can build a number of secure synchronization schemes.

## Mutual Exclusion

The lowest-level method of blocking other threads from running uses a global *thread-critical* condition. When the condition is set to `true` (using the `Thread.critical=` method), the scheduler will not schedule any existing thread to run. However, this does not block new threads from being created and run. Certain thread operations (such as stopping or killing a thread, sleeping in the current thread, and raising an exception) may cause a thread to be scheduled even when in a critical section.

Using `Thread.critical=` directly is certainly possible, but it isn’t terribly convenient. In fact, we strongly recommend you don’t use it unless you have a black belt in multithreading (and a penchant for long debugging sessions). Fortunately, Ruby comes packaged with several alternatives. Right now we’ll look at one of these, the `Monitor` library. You may also want to look at the `Sync` library (on page 717), the `Mutex_m` library (beginning on page 676), and the `Queue` class implemented in the `thread` library (on page 722).

## Monitors

While the threading primitives provide basic synchronization, they can be tricky to use. Over the years, various folks have come up with higher-level alternatives. One that works particularly well in object-oriented systems is the concept of a *monitor*.

Monitors wrap an object containing some kind of resource with synchronization functions. To see them in action, let's look at a simple counter that is accessed from two threads.

```
class Counter
 attr_reader :count
 def initialize
 @count = 0
 super
 end
 def tick
 @count += 1
 end
end

c = Counter.new

t1 = Thread.new { 10000.times { c.tick } }
t2 = Thread.new { 10000.times { c.tick } }

t1.join
t2.join

c.count → 11319
```

Perhaps surprisingly, the count doesn't equal 20,000. The reason is a simple line of code.

```
@count += 1
```

This line is actually more complex than it first appears. Within the Ruby interpreter, it might break down into

```
val = fetch_current(@count)
add 1 to val
store val back into @count
```

Now imagine two threads executing this code at the same time. Table 11.1 on the next page shows the thread number (*t1* and *t2*), the code being executed, and the value of the counter (which we initialize to 0).

Even though our basic set of load/add/store instructions executed five times, we ended up with a count of three. Because thread 1 interrupted the execution of thread 2 in the middle of a sequence, when thread 2 resumed it stored a stale value back into @count.

Table 11.1. Two threads in a race condition

| Thread | Executes...                 | Result     |
|--------|-----------------------------|------------|
| t1:    | val = fetch_current(@count) | @count = 0 |
| t1:    | add 1 to val                | 0          |
| t1:    | store val back into @count  | @count = 1 |
| t2:    | val = fetch_current(@count) | 1          |
| t2:    | add 1 to val                | 1          |
| t2:    | store val back into @count  | @count = 2 |
| t1:    | val = fetch_current(@count) | 2          |
| t2:    | val = fetch_current(@count) | 2          |
| t1:    | add 1 to val                | 2          |
| t1:    | store val back into @count  | @count = 3 |
| t1:    | val = fetch_current(@count) | 3          |
| t1:    | add 1 to val                | 3          |
| t1:    | store val back into @count  | @count = 4 |
| t2:    | add 1 to val                | 4          |
| t2:    | store val back into @count  | @count = 3 |

The solution is to arrange things so that only one thread can execute the tick method's increment at any one time. This is easy using monitors.

```
require 'monitor'
class Counter < Monitor
 attr_reader :count
 def initialize
 @count = 0
 super
 end
 def tick
 synchronize do
 @count += 1
 end
 end
end

c = Counter.new
t1 = Thread.new { 10000.times { c.tick } }
t2 = Thread.new { 10000.times { c.tick } }

t1.join; t2.join
c.count → 20000
```

By making our counter a monitor, it gains access to the synchronize method. Only one thread can be executing code within a synchronize block for a particular monitor object at any one time, so we no longer have two threads caching intermediate results at the same time, and our count has its expected value.

We don't have to make our class a subclass of `Monitor` to gain these benefits. We could also mix in a variant, `MonitorMixin`.

```
require 'monitor'
class Counter
 include MonitorMixin
 . . .
end
```

The previous example put the synchronization inside the resource being synchronized. This is appropriate when all accesses to all objects of the class require synchronization. But if you want to control access to objects that require synchronization only in some circumstances, or if the synchronization is spread across a group of objects, then it may be better to use an external monitor.

```
require 'monitor'

class Counter
 attr_reader :count
 def initialize
 @count = 0
 end
 def tick
 @count += 1
 end
end

c = Counter.new
lock = Monitor.new

t1 = Thread.new { 10000.times { lock.synchronize { c.tick } } }
t2 = Thread.new { 10000.times { lock.synchronize { c.tick } } }
t1.join; t2.join

c.count → 20000
```

We can even make specific objects into monitors.

```
require 'monitor'

class Counter
 # as before...
end

c = Counter.new
c.extend(MonitorMixin)

t1 = Thread.new { 10000.times { c.synchronize { c.tick } } }
t2 = Thread.new { 10000.times { c.synchronize { c.tick } } }

t1.join; t2.join
c.count → 20000
```

Here, because class `Counter` doesn't know it is a monitor at the time it's defined, we have to perform the synchronization externally (in this case by wrapping the calls to `c.tick`). This is clearly a tad dangerous: if some other code calls `tick` but doesn't realize that synchronization is required, we're back in the same mess we started with.

## Queues

Most of the examples in this chapter use the `Monitor` class for synchronization. However, another technique is useful, particularly when you need to synchronize work between producers and consumers. The `Queue` class, located in the `thread` library, implements a thread-safe queuing mechanism. Multiple threads can add and remove objects from the queue, and each addition and removal is guaranteed to be atomic. For an example of this, see the description of the `thread` library on page 722.

## Condition Variables

Monitors give us half of what we need, but there's a problem. Say we have two threads accessing a shared queue. One needs to add entries, and the other needs to read them (perhaps the list represents songs waiting to be played on our jukebox: it gets added to when customers make selections, and gets emptied as records get played).

We know we need to synchronize access, so we try something like

```
require 'monitor'
playlist = []
playlist.extend(MonitorMixin)
Player thread
Thread.new do
 record = nil
 loop do
 playlist.synchronize do # << BUG!!!
 sleep 0.1 while playlist.empty?
 record = playlist.shift
 end
 play(record)
 end
end
Customer request thread thread
Thread.new do
 loop do
 req = get_customer_request
 playlist.synchronize do
 playlist << req
 end
 end
end
end
```

But this code has a problem. Inside the player thread, we gain access to the monitor and then loop waiting for something to be added to the playlist. But because we own the monitor, the customer thread will never be able to enter its synchronized block, and will never add something to the playlist. We're stuck. What we need is to be able to signal that the playlist has something in it and to provide synchronization between threads based on this condition, all while staying within the safety of a monitor. More generally, we need to be able to give up temporarily the exclusive use of the critical region and simultaneously tell people that we're waiting for a resource. When the resource becomes available, we need to be able to grab it *and* reobtain the lock on the critical region, all in one step.

That's where *condition variables* come in. A condition variable is a controlled way of communicating an event (or a condition) between two threads. One thread can wait on the condition, and the other can signal it. For example, we could rewrite our jukebox using condition variables. (For the purposes of this code we'll write stub methods for receiving customer requests and playing records. We also have to add a flag to tell the player that it's OK to shut down; normally it would run forever.)

```
require 'monitor'
SONGS = [
 'Blue Suede Shoes',
 'Take Five',
 'Bye Bye Love',
 'Rock Around The Clock',
 'Ruby Tuesday'
]
START_TIME = Time.now
def timestamp
 (Time.now - START_TIME).to_i
end
Wait for up to two minutes between customer requests
def get_customer_request
 sleep(120 * rand)
 song = SONGS.shift
 puts "#{timestamp}: Requesting #{song}" if song
 song
end
Songs take between two and three minutes
def play(song)
 puts "#{timestamp}: Playing #{song}"
 sleep(120 + 60*rand)
end
ok_to_shutdown = false
and here's our original code
playlist = []
playlist.extend(MonitorMixin)
```

```

plays_pending = playlist.new_cond
Customer request thread thread
customer = Thread.new do
 loop do
 req = get_customer_request
 break unless req
 playlist.synchronize do
 playlist << req
 plays_pending.signal
 end
 end
end
Player thread
player = Thread.new do
 loop do
 song = nil
 playlist.synchronize do
 break if ok_to_shutdown && playlist.empty?
 plays_pending.wait_while { playlist.empty? }
 song = playlist.shift
 end
 break unless song
 play(song)
 end
end
customer.join
ok_to_shutdown = true
player.join

```

*produces:*

```

26: Requesting Blue Suede Shoes
28: Playing Blue Suede Shoes
72: Requesting Take Five
188: Requesting Bye Bye Love
214: Playing Take Five
288: Requesting Rock Around The Clock
299: Requesting Ruby Tuesday
396: Playing Bye Bye Love
563: Playing Rock Around The Clock
708: Playing Ruby Tuesday

```

## Running Multiple Processes

Sometimes you may want to split a task into several process-sized chunks—or perhaps you need to run a separate process that was not written in Ruby. Not a problem: Ruby has a number of methods by which you may spawn and manage separate processes.

## Spawning New Processes

You have several ways to spawn a separate process; the easiest is to run some command and wait for it to complete. You may find yourself doing this to run some separate command or retrieve data from the host system. Ruby does this for you with the `system` and backquote (or backtick) methods.

```
system("tar xzf test.tgz") → true
result = `date`
result → "Thu Aug 26 22:36:55 CDT 2004\n"
```

The method `Kernel.system` executes the given command in a subprocess; it returns `true` if the command was found and executed properly and `false` otherwise. In case of failure, you'll find the subprocess's exit code in the global variable `$?`.

One problem with `system` is that the command's output will simply go to the same destination as your program's output, which may not be what you want. To capture the standard output of a subprocess, you can use the backquote characters, as with ``date`` in the previous example. Remember that you may need to use `String#chomp` to remove the line-ending characters from the result.

OK, this is fine for simple cases—we can run some other process and get the return status. But many times we need a bit more control than that. We'd like to carry on a conversation with the subprocess, possibly sending it data and possibly getting some back. The method `IO.popen` does just this. The `popen` method runs a command as a subprocess and connects that subprocess's standard input and standard output to a Ruby `IO` object. Write to the `IO` object, and the subprocess can read it on standard input. Whatever the subprocess writes is available in the Ruby program by reading from the `IO` object.

For example, on our systems one of the more useful utilities is `pig`, a program that reads words from standard input and prints them in pig latin (or igpay atinlay). We can use this when our Ruby programs need to send us output that our five-year-olds shouldn't be able to understand.

```
pig = IO.popen("/usr/local/bin/pig", "w+")
pig.puts "ice cream after they go to bed"
pig.close_write
puts pig.gets
```

*produces:*

```
iceway eamcray afterway eythay ogay otay edbay
```

This example illustrates both the apparent simplicity and the real-world complexities involved in driving subprocesses through pipes. The code certainly looks simple enough: open the pipe, write a phrase, and read back the response. But it turns out that the `pig` program doesn't flush the output it writes. Our original attempt at this example, which had a `pig.puts` followed by a `pig.gets`, hung forever. The `pig` program



processed our input, but its response was never written to the pipe. We had to insert the `pipe.close_write` line. This sends an end-of-file to `pig`'s standard input, and the output we're looking for gets flushed as `pig` terminates.

`popen` has one more twist. If the command you pass it is a single minus sign (`-`), `popen` will fork a new Ruby interpreter. Both this and the original interpreter will continue running by returning from the `popen`. The original process will receive an `IO` object back, and the child will receive `nil`. This works only on operating systems that support the `fork(2)` call (and for now this excludes Windows).

```
pipe = IO.popen("-", "w+")
if pipe
 pipe.puts "Get a job!"
 STDERR.puts "Child says '#{pipe.gets.chomp}'"
else
 STDERR.puts "Dad says '#{gets.chomp}'"
 puts "OK"
end
```

*produces:*

```
Dad says 'Get a job!'
Child says 'OK'
```

In addition to the `popen` method, some platforms support the methods `Kernel.fork`, `Kernel.exec`, and `IO.pipe`. The file-naming convention of many `IO` methods and `Kernel.open` will also spawn subprocesses if you put a `|` as the first character of the filename (see the introduction to class `IO` on page 482 for details). Note that you *cannot* create pipes using `File.new`; it's just for files.

## Independent Children

Sometimes we don't need to be quite so hands-on: we'd like to give the subprocess its assignment and then go on about our business. Sometime later, we'll check to see if it has finished. For instance, we may want to kick off a long-running external sort.

```
exec("sort testfile > output.txt") if fork.nil?
The sort is now running in a child process
carry on processing in the main program
... dum di dum ...
then wait for the sort to finish
Process.wait
```

The call to `Kernel.fork` returns a process ID in the parent, and `nil` in the child, so the child process will perform the `Kernel.exec` call and run `sort`. Sometime later, we issue a `Process.wait` call, which waits for the sort to complete (and returns its process ID).

If you'd rather be notified when a child exits (instead of just waiting around), you can set up a signal handler using `Kernel.trap` (described on page 513). Here we set up a trap on `SIGCLD`, which is the signal sent on “death of child process.”

```
trap("CLD") do
 pid = Process.wait
 puts "Child pid #{pid}: terminated"
end
exec("sort testfile > output.txt") if fork.nil?
do other stuff...
```

*produces:*

```
Child pid 25816: terminated
```

For more information on using and controlling external processes, see the documentation for `Kernel.open`, `IO.popen`, and the section on the `Process` module on page 562.

## Blocks and Subprocesses

`IO.popen` works with a block in pretty much the same way as `File.open` does. If you pass it a command, such as `date`, the block will be passed an `IO` object as a parameter.

```
IO.popen("date") {|f| puts "Date is #{f.gets}" }
```

*produces:*

```
Date is Thu Aug 26 22:36:55 CDT 2004
```

The `IO` object will be closed automatically when the code block exits, just as it is with `File.open`.

If you associate a block with `Kernel.fork`, the code in the block will be run in a Ruby subprocess, and the parent will continue after the block.

```
fork do
 puts "In child, pid = #$$"
 exit 99
end
pid = Process.wait
puts "Child terminated, pid = #{pid}, status = #{$?.exitstatus}"
```

*produces:*

```
In child, pid = 25823
Child terminated, pid = 25823, status = 99
```

`$?`  is a global variable that contains information on the termination of a subprocess. See the section on `Process::Status` beginning on page 570 for more information.

# Unit Testing

---

Unit testing (described in the sidebar on the next page) is a technique that helps developers write better code. It helps before the code is actually written, as thinking about testing leads you naturally to create better, more decoupled designs. It helps as you're writing the code, as it gives you instant feedback on how accurate your code is. And it helps after you've written code, both because it gives you the ability to check that the code still works and because it helps others understand how to use your code.

Unit testing is a Good Thing.

But why have a chapter on unit testing in the middle of a book on Ruby? Because unit testing and languages such as Ruby seem to go hand in hand. The flexibility of Ruby makes writing tests easy, and the tests make it easier to verify that your code is working. Once you get into the swing of it, you'll find yourself writing a little code, writing a test or two, verifying that everything is copacetic, and then writing some more code.

Unit testing is also pretty trivial—run a program that calls part of your application's code, get back some results, and then check the results are what you expected.

Let's say we're testing a Roman number class. So far the code is pretty simple: it just lets us create an object representing a certain number and display that object in Roman numerals. Figure 12.1 on page 145 shows our first stab at an implementation.

We could test this code by writing another program, like this.

```
require 'roman'
r = Roman.new(1)
fail "'i' expected" unless r.to_s == "i"
r = Roman.new(9)
fail "'ix' expected" unless r.to_s == "ix"
```

However, as the number of tests in a project grows, this kind of ad-hoc approach can start to get complicated to manage. Over the years, various unit testing frameworks have emerged to help structure the testing process. Ruby comes with one preinstalled, Nathaniel Talbott's Test::Unit framework.

### **What is Unit Testing?**

Unit testing focuses on small chunks (units) of code, typically individual methods or lines within methods. This is in contrast to most other forms of testing, which consider the system as a whole.

Why focus in so tightly? Because ultimately all software is constructed in layers: code on one layer relies on the correct operation of the code in the layers below. If this underlying code turns out to contain bugs, then all higher layers are potentially affected. This is a big problem. Fred may write the code with a bug one week, and then you may end up calling it, indirectly, two months later. When your code generates incorrect results, it will take you a while to track down the problem in Fred's method. And when you ask Fred why he wrote it that way, the likely answer will be "I don't remember. That was months ago."

If instead Fred had unit tested his code when he wrote it, two things would have happened. First, he'd have found the bug while the code was still fresh in his mind. Second, because the unit test was only looking at the code he'd just written, when the bug *did* appear, he'd only have to look through a handful of lines of code to find it, rather than doing archaeology on the rest of the code base.

## **Test::Unit Framework**

The Test::Unit framework is basically three facilities wrapped into a neat package.

1. It gives you a way of expressing individual tests.
2. It provides a framework for structuring the tests.
3. It gives you flexible ways of invoking the tests.

### **Assertions == Expected Results**

Rather than have you write series of individual `if` statements in your tests, Test::Unit provides a series of assertions that achieve the same thing. Although a number of different styles of assertion exist, they all follow basically the same pattern. Each assertion gives you a way of specifying a desired result or outcome and a way of passing in the actual outcome. If the actual doesn't equal the expected, the assertion outputs a nice message and records the fact as a failure.

For example, we could rewrite our previous test of the Roman class in Test::Unit. For now, ignore the scaffolding code at the start and end, and just look at the `assert_equal` methods.

Figure 12.1. Roman numerals generation (with bugs)

```

class Roman
 MAX_ROMAN = 4999

 def initialize(value)
 if value <= 0 || value > MAX_ROMAN
 fail "Roman values must be > 0 and <= #{MAX_ROMAN}"
 end
 @value = value
 end

 FACTORS = [
 ["m", 1000], ["cm", 900], ["d", 500], ["cd", 400],
 ["c", 100], ["xc", 90], ["l", 50], ["xl", 40],
 ["x", 10], ["ix", 9], ["v", 5], ["iv", 4],
 ["i", 1]
]

 def to_s
 value = @value
 roman = ""
 for code, factor in FACTORS
 count, value = value.divmod(factor)
 roman << code unless count.zero?
 end
 roman
 end
end

```

```

require 'roman'
require 'test/unit'
class TestRoman < Test::Unit::TestCase
 def test_simple
 assert_equal("i", Roman.new(1).to_s)
 assert_equal("ix", Roman.new(9).to_s)
 end
end

```

*produces:*

```

Loaded suite -
Started
.
Finished in 0.001672 seconds.

```

```

1 tests, 2 assertions, 0 failures, 0 errors

```

The first assertion says that we’re expecting the Roman number string representation of 1 to be “i”, and the second test says we expect 9 to be “ix”. Luckily for us, both expectations are met, and the tracing reports that our tests pass.

Let’s add a few more tests.

```

require 'roman'
require 'test/unit'
class TestRoman < Test::Unit::TestCase
 def test_simple
 assert_equal("i", Roman.new(1).to_s)
 assert_equal("ii", Roman.new(2).to_s)
 assert_equal("iii", Roman.new(3).to_s)
 assert_equal("iv", Roman.new(4).to_s)
 assert_equal("ix", Roman.new(9).to_s)
 end
end

```

*produces:*

```

Loaded suite -
Started
F
Finished in 0.021083 seconds.

```

```

 1) Failure:
<"ii"> expected but was
<"i">.

```

```

1 tests, 2 assertions, 1 failures, 0 errors
test_simple(TestRoman) [prog.rb:6]:

```

Uh oh! The second assertion failed. See how the error message uses the fact that the assert knows both the expected and actual values: it expected to get “ii” but instead got “i”. Looking at our code, you can see a clear bug in `to_s`. If the count after dividing by the factor is greater than zero, then we should output that many Roman digits. The existing code outputs just one. The fix is easy.

```

def to_s
 value = @value
 roman = ""
 for code, factor in FACTORS
 count, value = value.divmod(factor)
 roman << (code * count)
 end
 roman
end

```

Now let’s run our tests again.

```

Loaded suite -
Started
.
Finished in 0.002869 seconds.

```

```

1 tests, 5 assertions, 0 failures, 0 errors

```

Looking good. We can now go a step further and remove some of that duplication.

```

require 'roman'
require 'test/unit'
class TestRoman < Test::Unit::TestCase
 NUMBERS = [
 [1, "i"], [2, "ii"], [3, "iii"],
 [4, "iv"], [5, "v"], [9, "ix"]
]
 def test_simple
 NUMBERS.each do |arabic, roman|
 r = Roman.new(arabic)
 assert_equal(roman, r.to_s)
 end
 end
end

```

*produces:*

```

Loaded suite -
Started
.
Finished in 0.002638 seconds.

```

1 tests, 6 assertions, 0 failures, 0 errors

What else can we test? Well, the constructor checks that the number we pass in can be represented as a Roman number, throwing an exception if it can't. Let's test the exception.

```

require 'roman'
require 'test/unit'
class TestRoman < Test::Unit::TestCase
 def test_range
 assert_raise(RuntimeError) { Roman.new(0) }
 assert_nothing_raised() { Roman.new(1) }
 assert_nothing_raised() { Roman.new(4999) }
 assert_raise(RuntimeError) { Roman.new(5000) }
 end
end

```

*produces:*

```

Loaded suite -
Started
.
Finished in 0.002588 seconds.

```

1 tests, 4 assertions, 0 failures, 0 errors

We could do lot more testing on our Roman class, but let's move on to bigger and better things. Before we go, though, we should say that we've only scratched the surface of the set of assertions available inside Test::Unit. Figure 12.2 on page 154 gives a full list. The final parameter to every assertion is a message, which is output before any

failure message. This normally isn't needed, as `Test::Unit`'s messages are normally pretty reasonable. The one exception is the test `assert_not_nil`, where the message “<nil> expected to not be nil” doesn't help much. In that case, you may want to add some annotation of your own.

```
require 'test/unit'
class TestsWhichFail < Test::Unit::TestCase
 def test_reading
 assert_not_nil(ARGF.read, "Read next line of input")
 end
end
```

*produces:*

```
Loaded suite -
Started
F
Finished in 0.022314 seconds.
```

```
1) Failure:
Read next line of input.
<nil> expected to not be nil.
```

```
1 tests, 1 assertions, 1 failures, 0 errors
test_reading(TestsWhichFail) [prog.rb:4]:
```

## Structuring Tests

Earlier we asked you to ignore the scaffolding around our tests. Now it's time to look at it.

You include `Test::Unit` facilities in your unit test with the following line.

```
require 'test/unit'
```

Unit tests seem to fall quite naturally into high-level groupings, called *test cases*, and lower level groupings, the test methods themselves. The test cases generally contain all the tests relating to a particular facility or feature. Our Roman number class is fairly simple, so all the tests for it will probably be in a single test case. Within the test case, you'll probably want to organize your assertions into a number of test methods, where each method contains the assertions for one type of test: one method could check regular number conversions, another could test error handling, and so on.

The classes that represent test cases must be subclasses of `Test::Unit::TestCase`. The methods that hold the assertions must have names that start with `test`. This is important: `Test::Unit` uses reflection to find tests to run, and only methods whose names start with `test` are eligible.



Quite often you'll find all of the test methods within a test case setting up a particular scenario. Each test method then probes some aspect of that scenario. Finally, each method may then tidy up after itself. For example, we could be testing a class that extracts jukebox playlists from a database.

```
require 'test/unit'
require 'playlist_builder'
require 'dbi'

class TestPlaylistBuilder < Test::Unit::TestCase
 def test_empty_playlist
 db = DBI.connect('DBI:mysql:playlists')
 pb = PlaylistBuilder.new(db)
 assert_equal([], pb.playlist())
 db.disconnect
 end

 def test_artist_playlist
 db = DBI.connect('DBI:mysql:playlists')
 pb = PlaylistBuilder.new(db)
 pb.include_artist("krauss")
 assert(pb.playlist.size > 0, "Playlist shouldn't be empty")
 pb.playlist.each do |entry|
 assert_match(/krauss/i, entry.artist)
 end
 db.disconnect
 end

 def test_title_playlist
 db = DBI.connect('DBI:mysql:playlists')
 pb = PlaylistBuilder.new(db)
 pb.include_title("midnight")
 assert(pb.playlist.size > 0, "Playlist shouldn't be empty")
 pb.playlist.each do |entry|
 assert_match(/midnight/i, entry.title)
 end
 db.disconnect
 end

 # ...
end
```

*produces:*

```
Loaded suite -
Started
...
Finished in 0.23465 seconds.
```

```
3 tests, 23 assertions, 0 failures, 0 errors
```

Each test starts by connecting to the database and creating a new playlist builder. Each test ends by disconnecting from the database. (The idea of using a real database in unit

tests is questionable, as unit tests are supposed to be fast running, context independent, and easy to set up, but it illustrates a point.)

We can extract all this common code into *setup* and *teardown* methods. Within a `TestCase` class, a method called `setup` will be run before each and every test method, and a method called `teardown` will be run after each test method finishes. Let's emphasize that: the `setup` and `teardown` methods bracket each test, rather than being run once per test case.

Our test would then become

```
require 'test/unit'
require 'playlist_builder'
require 'dbi'
class TestPlaylistBuilder < Test::Unit::TestCase
 def setup
 @db = DBI.connect('DBI:mysql:playlists')
 @pb = PlaylistBuilder.new(@db)
 end
 def teardown
 @db.disconnect
 end
 def test_empty_playlist
 assert_equal([], @pb.playlist())
 end
 def test_artist_playlist
 @pb.include_artist("krauss")
 assert(@pb.playlist.size > 0, "Playlist shouldn't be empty")
 @pb.playlist.each do |entry|
 assert_match(/krauss/i, entry.artist)
 end
 end
 def test_title_playlist
 @pb.include_title("midnight")
 assert(@pb.playlist.size > 0, "Playlist shouldn't be empty")
 @pb.playlist.each do |entry|
 assert_match(/midnight/i, entry.title)
 end
 end
 # ...
end
```

*produces:*

```
Loaded suite -
Started
...
Finished in 0.248365 seconds.

3 tests, 23 assertions, 0 failures, 0 errors
```

## Organizing and Running Tests

The test cases we’ve shown so far are all runnable `Test::Unit` programs. If, for example, the test case for the Roman class was in a file called `test_roman.rb`, we could run the tests from the command line using

```
% ruby test_roman.rb
Loaded suite test_roman
Started
..
Finished in 0.039257 seconds.

2 tests, 9 assertions, 0 failures, 0 errors
```

`Test::Unit` is clever enough to notice that there’s no main program, so it collects up all the test case classes and runs each in turn.

If we want, we can ask it to run just a particular test method.

```
% ruby test_roman.rb --name test_range
Loaded suite test_roman
Started
.
Finished in 0.006445 seconds.

1 tests, 4 assertions, 0 failures, 0 errors
```

## Where to Put Tests

Once you get into unit testing, you may well find yourself generating almost as much test code as production code. All of those tests have to live somewhere. The problem is that if you put them alongside your regular production code source files, your directories start to get bloated—effectively you end up with two files for every production source file.

A common solution is to have a `test/` directory where you place all your test source files. This directory is then placed parallel to the directory containing the code you’re developing. For example, for our Roman numeral class, we may have

```
roman
├── lib/
│ ├── roman.rb
│ └── other files...
├── test/
│ ├── test_roman.rb
│ └── other tests...
└── other stuff
```

This works well as a way of organizing files but leaves you with a small problem: how do you tell Ruby where to find the library files to test? For example, if our `TestRoman` test code was in a `test/` subdirectory, how does Ruby know where to find the `roman.rb` source file, the thing we're trying to test?

An option that *doesn't* work reliably is to build the path into `require` statements in the test and run the tests from the `test/` subdirectory.

```
require 'test/unit'
require '../lib/roman'
class TestRoman < Test::Unit::TestCase
 # ...
end
```

Why doesn't it work? Because our `roman.rb` file may itself require other source files in the library we're writing. It'll load them using `require` (without the leading `../lib/`), and because they aren't in Ruby's `$LOAD_PATH`, they won't be found. Our test just won't run. A second, less immediate problem is that we won't be able to use these same tests to test our classes once installed on a target system, as then they'll be referenced simply using `require 'roman'`.

A better solution is to run the tests from the directory containing the library being tested. Because the current directory is in the load path, the test code will be able to find it.

```
% ruby ../test/test_roman.rb
```

However, this approach breaks down if you want to be able to run the tests from somewhere else on your system. Perhaps your scheduled build process runs tests for all the software in the application by simply looking for files called `test_XXX` and executing them. In this case, you need a little load path magic. At the front of your test code (for example in `test_roman.rb`), add the following line:

```
$.unshift File.join(File.dirname(__FILE__), "..", "lib")
require ...
```

This magic works because the test code is in a known location relative to the code being tested. It starts by working out the name of the directory from which the test file is run and then constructing the path to the files under test. This directory is the prepended to the load path (the variable `$:`). From then on, code such as `require 'roman'` will search the library being tested first.

## Test Suites

After a while, you'll grow a decent collection of test cases for your application. You may well find that these tend to cluster: one group of cases tests a particular set of functions, and another group tests a different set of functions. If so, you can group those test cases together into *test suites*, letting you run them all as a group.

This is easy to do in `Test::Unit`. All you have to do is create a Ruby file that requires `test/unit`, and then requires each of the files holding the test cases you want to group. This way, you build yourself a hierarchy of test material

- You can run individual tests by name.
- You can run all the tests in a file by running that file.
- You can group a number of files into a test suite and run them as a unit.
- You can group test suites into other test suites.

This gives you the ability to run your unit tests at a level of granularity that you control, testing just one method or testing the entire application.

At this point, it's worthwhile thinking about naming conventions. Nathaniel Talbott, the author of `Test::Unit`, uses the convention that test cases are in files named `tc_XXX` and test suites are in files named `ts_XXX`.

```
file ts_dbaccess.rb
require 'test/unit'
require 'tc_connect'
require 'tc_query'
require 'tc_update'
require 'tc_delete'
```

Now, if you run Ruby on the file `ts_dbaccess.rb`, you execute the test cases in the four files you've required.

Is that all there is to it? No, you can make it more complicated if you want. You can manually create and populate `TestSuite` objects, but there doesn't seem to be much point in practice. If you want to find more information, `ri Test::Unit` should help.

`Test::Unit` comes with a number of fancy GUI test runners. As *real* programmers use the command line, however, these aren't described here. Again, see the documentation for details.

Figure 12.2. Test::Unit assertions

```

assert(boolean, [message])
 Fails if boolean is false or nil.

assert_nil(obj, [message])
assert_not_nil(obj, [message])
 Expects obj to be (not) nil.

assert_equal(expected, actual, [message])
assert_not_equal(expected, actual, [message])
 Expects obj to equal/not equal expected, using ==.

assert_in_delta(expected_float, actual_float, delta, [message])
 Expects that the actual floating-point value is within delta of the expected value.

assert_raise(Exception, ...) { block }
assert_nothing_raised(Exception, ...) { block }
 Expects the block to (not) raise one of the listed exceptions.

assert_instance_of(klass, obj, [message])
assert_kind_of(klass, obj, [message])
 Expects obj to be a kind/instance of klass.

assert_respond_to(obj, message, [message])
 Expects obj to respond to message (a symbol).

assert_match(regexp, string, [message])
assert_no_match(regexp, string, [message])
 Expects string to (not) match regexp.

assert_same(expected, actual, [message])
assert_not_same(expected, actual, [message])
 Expects expected.equal?(actual).

assert_operator(obj1, operator, obj2, [message])
 Expects the result of sending the message operator to obj1 with parameter obj2 to
 be true.

assert_throws(expected_symbol, [message]) { block }
 Expects the block to throw the given symbol.

assert_send(send_array, [message])
 Sends the message in send_array[1] to the receiver in send_array[0], passing the
 rest of send_array as arguments. Expects the return value to be true.

flunk(message="Flunked")
 Always fail.

```

# When Trouble Strikes

---

Sad to say, it is possible to write buggy programs using Ruby. Sorry about that.

But not to worry! Ruby has several features that will help debug your programs. We'll look at these features, and then we'll show some common mistakes you can make in Ruby and how to fix them.

## Ruby Debugger

Ruby comes with a debugger, which is conveniently built into the base system. You can run the debugger by invoking the interpreter with the `-r debug` option, along with any other Ruby options and the name of your script.

```
ruby -r debug [debug-options] [programfile] [program-arguments]
```

The debugger supports the usual range of features you'd expect, including the ability to set breakpoints, to step into and step over method calls, and to display stack frames and variables. It can also list the instance methods defined for a particular object or class, and it allows you to list and control separate threads within Ruby. Table 13.1 on page 165 lists all the commands that are available under the debugger.

If your Ruby installation has `readline` support enabled, you can use cursor keys to move back and forth in command history and use line-editing commands to amend previous input.

To give you an idea of what the Ruby debugger is like, here is a sample session (with user input in bold face type).

```
% ruby -r debug t.rb
Debug.rb
Emacs support available.
t.rb:1: def fact(n)
(rdb:1) list 1-9
[1, 10] in t.rb
```

```

=> 1 def fact(n)
 2 if n <= 0
 3 1
 4 else
 5 n * fact(n-1)
 6 end
 7 end
 8
 9 p fact(5)
(rdb:1) b 2
Set breakpoint 1 at t.rb:2
(rdb:1) c
breakpoint 1, fact at t.rb:2
t.rb:2: if n <= 0
(rdb:1) disp n
 1: n = 5
(rdb:1) del 1
(rdb:1) watch n==1
Set watchpoint 2
(rdb:1) c
watchpoint 2, fact at t.rb:fact
t.rb:1: def fact(n)
 1: n = 1
(rdb:1) where
--> #1 t.rb:1:in `fact'
 #2 t.rb:5:in `fact'
 #3 t.rb:5:in `fact'
 #4 t.rb:5:in `fact'
 #5 t.rb:5:in `fact'
 #6 t.rb:9
(rdb:1) del 2
(rdb:1) c
120

```

## Interactive Ruby

If you want to play with Ruby, we recommend Interactive Ruby—`irb`, for short. `irb` is essentially a Ruby “shell” similar in concept to an operating system shell (complete with job control). It provides an environment where you can “play around” with the language in real time. You launch `irb` at the command prompt.

```
irb [irb-options] [ruby_script] [program-arguments]
```

`irb` will display the value of each expression as you complete it. For instance:

```

% irb
irb(main):001:0> a = 1 +
irb(main):002:0* 2 * 3 /
irb(main):003:0* 4 % 5

```



```

=> 2
irb(main):004:0> 2+2
=> 4
irb(main):005:0> def test
irb(main):006:1> puts "Hello, world!"
irb(main):007:1> end
=> nil
irb(main):008:0> test
Hello, world!
=> nil
irb(main):009:0>

```

irb also allows you to create subsessions, each one of which may have its own context. For example, you can create a subsession with the same (top-level) context as the original session or create a subsession in the context of a particular class or instance. The sample session shown in Figure 13.1 on the next page is a bit longer but shows how you can create subsessions and switch between them.

For a full description of all the commands that irb supports, see the reference beginning on page 174.

As with the debugger, if your version of Ruby was built with GNU readline support, you can use arrow keys (as with Emacs) or vi-style key bindings to edit individual lines or to go back and reexecute or edit a previous line—just like a command shell.

irb is a great learning tool: it's very handy if you want to try an idea quickly and see if it works.

## Editor Support

The Ruby interpreter is designed to read a program in one pass; this means you can pipe an entire program to the interpreter's standard input, and it will work just fine.

We can take advantage of this feature to run Ruby code from inside an editor. In Emacs, for instance, you can select a region of Ruby text and use the command `Meta-|` to execute Ruby. The Ruby interpreter will use the selected region as standard input, and output will go to a buffer named `*Shell Command Output*`. This feature has come in quite handy for us while writing this book—just select a few lines of Ruby in the middle of a paragraph and try it!

You can do something similar in the vi editor using `:%!ruby` which *replaces* the program text with its output, or `:w_!ruby`, which displays the output without affecting the buffer. Other editors have similar features.

While we are on the subject, this would probably be a good place to mention that a Ruby mode for Emacs is included in the Ruby source distribution as `ruby-mode.el` in the `misc/` subdirectory. You can also find syntax-highlighting modules for vim

Figure 13.1. Sample irb session

```

% irb
irb(main):001:0> irb
irb#1(main):001:0> jobs
#0->irb on main (#<Thread:0x401bd654>: stop)
#1->irb#1 on main (#<Thread:0x401d5a28>: running)
irb#1(main):002:0> fg 0
#<IRB::Irb:@scanner=#<RubyLex:0x401ca7>,@signal_status=:IN_EVAL,
 @context=#<IRB::Context:0x401ca86c>>
irb(main):002:0> class VolumeKnob
irb(main):003:1> end
=> nil
irb(main):004:0> irb VolumeKnob
irb#2(VolumeKnob):001:0> def initialize
irb#2(VolumeKnob):002:1> @vol=50
irb#2(VolumeKnob):003:1> end
=> nil
irb#2(VolumeKnob):004:0> def up
irb#2(VolumeKnob):005:1> @vol += 10
irb#2(VolumeKnob):006:1> end
=> nil
irb#2(VolumeKnob):007:0> fg 0
#<IRB::Irb:@scanner=#<RubyLex:0x401ca7>,@signal_status=:IN_EVAL,
 @context=#<IRB::Context:0x401ca86c>>
irb(main):005:0> jobs
#0->irb on main (#<Thread:0x401bd654>: running)
#1->irb#1 on main (#<Thread:0x401d5a28>: stop)
#2->irb#2 on VolumeKnob (#<Thread:0x401c400c>: stop)
irb(main):006:0> VolumeKnob.instance_methods
=> ["up"]
irb(main):007:0> v = VolumeKnob.new
#<VolumeKnob: @vol=50>
irb(main):008:0> irb v
irb#3(#<VolumeKnob:0x401e7d40>):001:0> up
=> 60
irb#3(#<VolumeKnob:0x401e7d40>):002:0> up
=> 70
irb#3(#<VolumeKnob:0x401e7d40>):003:0> up
=> 80
irb#3(VolumeKnob):004:0> fg 0
#<IRB::Irb:@scanner=#<RubyLex:0x401ca7>,@signal_status=:IN_EVAL,
 @context=#<IRB::Context:0x401ca86c>>
irb(main):009:0> kill 1,2,3
=> [1, 2, 3]
irb(main):010:0> jobs
#0->irb on main (#<Thread:0x401bd654>: running)
irb(main):011:0> exit

```

In this same irb session, we'll create a new subsession in the context of class VolumeKnob.

We can use fg 0 to switch back to the main session, take a look at all current jobs, and see what instance methods VolumeKnob defines.

Make a new VolumeKnob object, and create a new subsession with that object as the context.

Switch back to the main session, kill the subsessions, and exit.

(an enhanced version of the vi editor), jed, and other editors on the 'net. Check the Ruby FAQ (<http://www.rubygarden.org/iowa/faqtotum>) for an up-to-date list and pointers to resources.

## But It Doesn't Work!

So you've read through enough of the book, you start to write your very own Ruby program, and it doesn't work. Here's a list of common gotchas and other tips.

- First and foremost, run your scripts with warnings enabled (the `-w` command-line option).
- If you happen to forget a “,” in an argument list—especially to print—you can produce some very odd error messages.
- A parse error at the last line of the source often indicates a missing end keyword, sometimes quite a bit earlier.
- An attribute setter is not being called. Within a class definition, Ruby will parse `setter=` as an assignment to a local variable, not as a method call. Use the form `self.setter=` to indicate the method call.

```
class Incorrect
 attr_accessor :one, :two
 def initialize
 one = 1 # incorrect - sets local variable
 self.two = 2
 end
end

obj = Incorrect.new
obj.one → nil
obj.two → 2
```

- Objects that don't appear to be properly set up may have been victims of an incorrectly spelled initialize method.

```
class Incorrect
 attr_reader :answer
 def initialise # <<< spelling error
 @answer = 42
 end
end

ultimate = Incorrect.new
ultimate.answer → nil
```

The same kind of thing can happen if you misspell the instance variable name.

```

class Incorrect
 attr_reader :answer
 def initialize
 @anwser = 42 #<< spelling error
 end
end

ultimate = Incorrect.new
ultimate.answer → nil

```

- Block parameters are in the same scope as local variables. If an existing local variable with the same name as a block parameter exists when the block executes, that variable will be modified by the call to the block. This may or may not be a Good Thing.

```

c = "carbon"
i = "iodine"
elements = [c, i]
elements.each_with_index do |element, i|
 # do some chemistry
end
c → "carbon"
i → 1

```

- Watch out for precedence issues, especially when using {} instead of do/end.

```

def one(arg)
 if block_given?
 "block given to 'one' returns #{yield}"
 else
 arg
 end
end

def two
 if block_given?
 "block given to 'two' returns #{yield}"
 end
end

result1 = one two {
 "three"
}

result2 = one two do
 "three"
end

puts "With braces, result = #{result1}"
puts "With do/end, result = #{result2}"

```

*produces:*

```

With braces, result = block given to 'two' returns three
With do/end, result = block given to 'one' returns three

```

- Output written to a terminal may be buffered. This means you may not see a message you write immediately. In addition, if you write messages to both `$stdout` and `$stderr`, the output may not appear in the order you were expecting. Always use nonbuffered I/O (set `sync=true`) for debug messages.
- If numbers don't come out right, perhaps they're strings. Text read from a file will be a `String` and will not be automatically converted to a number by Ruby. A call to `Integer` will work wonders (and will throw an exception if the input isn't a well-formed integer). A common mistake Perl programmers make is

```
while line = gets
 num1, num2 = line.split(/,/)
 # ...
end
```

You can rewrite this as

```
while line = gets
 num1, num2 = line.split(/,/)
 num1 = Integer(num1)
 num2 = Integer(num2)
 # ...
end
```

Or, you could convert all the strings using `map`.

```
while line = gets
 num1, num2 = line.split(/,/).map {|val| Integer(val) }
 # ...
end
```

- Unintended aliasing—if you are using an object as the key of a hash, make sure it doesn't change its hash value (or arrange to call `Hash#rehash` if it does).

```
arr = [1, 2]
hash = { arr => "value" }
hash[arr] → "value"
arr[0] = 99
hash[arr] → nil
hash.rehash → {[99, 2]=>"value"}
hash[arr] → "value"
```

- Make sure the class of the object you are using is what you think it is. If in doubt, use `puts my_obj.class`.
- Make sure your method names start with a lowercase letter and class and constant names start with an uppercase letter.
- If method calls aren't doing what you'd expect, make sure you've put parentheses around the arguments.

- Make sure the open parenthesis of a method's parameter list butts up against the end of the method name with no intervening spaces.
- Use `irb` and the debugger.
- Use `Object#freeze`. If you suspect that some unknown portion of code is setting a variable to a bogus value, try freezing the variable. The culprit will then be caught during the attempt to modify the variable.

One major technique makes writing Ruby code both easier and more fun. *Develop your applications incrementally*. Write a few lines of code, and then run them. Perhaps use `Test::Unit` to write some tests. Write a few more lines of code, and then exercise them. One of the major benefits of a dynamically typed language is that things don't have to be complete before you use them.

## But It's Too Slow!

Ruby is an interpreted, high-level language, and as such it may not perform as fast as a lower-level language such as C. In the following sections, we'll list some basic things you can do to improve performance; also have a look in the index under *Performance* for other pointers.

Typically, slow-running programs have one or two performance graveyards, places where execution time goes to die. Find and improve these, and suddenly your whole program springs back to life. The trick is finding them. The `Benchmark` module and the Ruby profilers can help.

### Benchmark

You can use the `Benchmark` module, also described on page 636, to time sections of code. For example, we may wonder which is faster: a large loop using variables local to the loop's block or using variables from the surrounding scope. Figure 13.2 on the following page shows how to use `Benchmark` to find out.

You have to be careful when benchmarking, because oftentimes Ruby programs can run slowly because of the overhead of garbage collection. Because this garbage collection can happen any time during your program's execution, you may find that benchmarking gives misleading results, showing a section of code running slowly when in fact the slowdown was caused because garbage collection happened to trigger while that code was executing. The `Benchmark` module has the `bmbm` method that runs the tests twice, once as a rehearsal and once to measure performance, in an attempt to minimize the distortion introduced by garbage collection. The benchmarking process itself is relatively well mannered—it doesn't slow down your program much.

Figure 13.2. Comparing variable access costs using benchmark

```

require 'benchmark'
include Benchmark

LOOP_COUNT = 1_000_000

bm(12) do |test|
 test.report("normal:") do
 LOOP_COUNT.times do |x|
 y = x + 1
 end
 end
 test.report("predefine:") do
 x = y = 0
 LOOP_COUNT.times do |x|
 y = x + 1
 end
 end
end
end

```

*produces:*

|            | user     | system   | total    | real        |
|------------|----------|----------|----------|-------------|
| normal:    | 3.110000 | 0.000000 | 3.110000 | ( 4.954929) |
| predefine: | 2.560000 | 0.000000 | 2.560000 | ( 3.009354) |

## The Profiler

Ruby comes with a code profiler (documentation begins on page 696). The profiler shows you the number of times each method in the program is called and the average and cumulative time that Ruby spends in those methods.

You can add profiling to your code using the command-line option `-r profile` or from within the code using `require 'profile'`. For example:

```

require 'profile'
count = 0
words = File.open("/usr/share/dict/words")
while word = words.gets
 word = word.chomp!
 if word.length == 12
 count += 1
 end
end
puts "#{count} twelve-character words"

```

The first time we ran this (without profiling) against a dictionary of almost 235,000 words, it takes several seconds to complete. This seems excessive, so we added the `-r profile` command-line option and tried again. Eventually we saw output that looked like the following.

```

20460 twelve-character words
% cumulative self self total
time seconds seconds calls ms/call ms/call name
7.76 12.01 12.01 234937 0.05 0.05 String#chomp!
7.75 24.00 11.99 234938 0.05 0.05 IO#gets
7.71 35.94 11.94 234937 0.05 0.05 String#length
7.62 47.74 11.80 234937 0.05 0.05 Fixnum#==
0.59 48.66 0.92 20460 0.04 0.04 Fixnum#+
0.01 48.68 0.02 1 20.00 20.00 Profiler__.start_profile
0.00 48.68 0.00 1 0.00 0.00 File#initialize
0.00 48.68 0.00 1 0.00 0.00 Fixnum#to_s
0.00 48.68 0.00 1 0.00 0.00 File#open
0.00 48.68 0.00 1 0.00 0.00 Kernel.puts
0.00 48.68 0.00 2 0.00 0.00 IO#write
0.00 48.68 0.00 1 0.00 154800.00 #toplevel

```

The first thing to notice is that the timings shown are a lot slower than when the program runs without the profiler. Profiling has a serious overhead, but the assumption is that it applies across the board, and therefore the relative numbers are still meaningful. This particular program clearly spends a lot of time in the loop, which executes almost 235,000 times. We could probably improve performance if we could either make the stuff in the loop less expensive or eliminate the loop altogether. One way of doing the latter is to read the word list into one long string, then use a pattern to match and extract all twelve character words.

```

require 'profile'
words = File.read("/usr/share/dict/words")
count = words.scan(PATT= /^.....\n/).size
puts "#{count} twelve-character words"

```

Our profile numbers are now a lot better (and the program runs more than five times faster when we take the profiling back out).

```

20460 twelve-character words
% cumulative self self total
time seconds seconds calls ms/call ms/call name
96.67 0.29 0.29 1 290.00 290.00 String#scan
6.67 0.31 0.02 1 20.00 20.00 Profiler__.start_profile
0.00 0.31 0.00 1 0.00 0.00 Array#size
0.00 0.31 0.00 1 0.00 0.00 Kernel.puts
0.00 0.31 0.00 2 0.00 0.00 IO#write
0.00 0.31 0.00 1 0.00 0.00 Fixnum#to_s
0.00 0.31 0.00 1 0.00 300.00 #toplevel
0.00 0.31 0.00 1 0.00 0.00 File#read

```

Remember to check the code without the profiler afterward, though—sometimes the slowdown the profiler introduces can mask other problems.

Ruby is a wonderfully transparent and expressive language, but it does not relieve the programmer of the need to apply common sense: creating unnecessary objects, performing unneeded work, and creating bloated code will slow down your programs regardless of the language.



Table 13.1. Debugger commands

|                                  |                                                                                                                      |
|----------------------------------|----------------------------------------------------------------------------------------------------------------------|
| b [reak] [file class:]line       | Set breakpoint at given line in <i>file</i> (default current file) or <i>class</i> .                                 |
| b [reak] [file class:]name       | Set breakpoint at <i>method</i> in <i>file</i> or <i>class</i> .                                                     |
| b [reak]                         | Display breakpoints and watchpoints.                                                                                 |
| wat [ch] expr                    | Break when expression becomes true.                                                                                  |
| del [ete] [nnn]                  | Delete breakpoint <i>nnn</i> (default all).                                                                          |
| cat [ch] exception               | Stop when <i>exception</i> is raised.                                                                                |
| cat [ch]                         | List current catches.                                                                                                |
| tr [ace] (on off) [all]          | Toggle execution trace of current or all threads.                                                                    |
| disp [lay] expr                  | Display value of <i>nnn</i> every time debugger gets control.                                                        |
| disp [lay]                       | Show current displays.                                                                                               |
| undisp [lay] [nnn]               | Remove display (default all).                                                                                        |
| c [ont]                          | Continue execution.                                                                                                  |
| s [tep] nnn=1                    | Execute next <i>nnn</i> lines, stepping into methods.                                                                |
| n [ext] nnn=1                    | Execute next <i>nnn</i> lines, stepping over methods.                                                                |
| fin [ish]                        | Finish execution of the current function.                                                                            |
| q [uit]                          | Exit the debugger.                                                                                                   |
| w [here]                         | Display current stack frame.                                                                                         |
| f [rame]                         | Synonym for where.                                                                                                   |
| l [ist] [start–end]              | List source lines from start to end.                                                                                 |
| up nnn=1                         | Move up <i>nnn</i> levels in the stack frame.                                                                        |
| down nnn=1                       | Move down <i>nnn</i> levels in the stack frame.                                                                      |
| v [ar] g [lobal]                 | Display global variables.                                                                                            |
| v [ar] l [ocal]                  | Display local variables.                                                                                             |
| v [ar] i [stance] <i>obj</i>     | Display instance variables of <i>obj</i> .                                                                           |
| v [ar] c [onst] Name             | Display constants in class or module name.                                                                           |
| m [ethod] i [nstance] <i>obj</i> | Display instance methods of <i>obj</i> .                                                                             |
| m [ethod] Name                   | Display instance methods of the class or module name.                                                                |
| th [read] l [ist]                | List all threads.                                                                                                    |
| th [read] c [ur[rent]]           | Display status of current thread.                                                                                    |
| th [read] c [ur[rent]] nnn       | Make thread <i>nnn</i> current, and stop it.                                                                         |
| th [read] stop nnn               | Make thread <i>nnn</i> current, and stop it.                                                                         |
| th [read] resume nnn             | Resume thread <i>nnn</i> .                                                                                           |
| th [read] sw [itch]] nnn         | Switch thread context to <i>nnn</i> .                                                                                |
| [p] expr                         | Evaluate <i>expr</i> in the current context. <i>expr</i> may include assignment to variables and method invocations. |
| h [elp]                          | Show summary of commands.                                                                                            |
| <i>empty</i>                     | A null command repeats the last command.                                                                             |

---

**Part II**

**Ruby in Its Setting**

---

# Ruby and Its World

---

It's an unfortunate fact of life that our applications have to deal with the big, bad world. In this chapter, we'll look at how Ruby interacts with its environment. Microsoft Windows users will probably also want to look at platform-specific information beginning on page [253](#).

## Command-Line Arguments

“In the beginning was the command line.”<sup>1</sup> Regardless of the system in which Ruby is deployed, whether it be a super high-end scientific graphics workstation or an embedded PDA device, you've got to start the Ruby interpreter somehow, and that gives us the opportunity to pass in command-line arguments.

A Ruby command line consists of three parts: options to the Ruby interpreter, optionally the name of a program to run, and optionally a set of arguments for that program.

```
ruby [options] [--] [programfile] [arguments]
```

The Ruby options are terminated by the first word on the command line that doesn't start with a hyphen, or by the special flag `--` (two hyphens).

If no filename is present on the command line, or if the filename is a single hyphen (`-`), Ruby reads the program source from standard input.

Arguments for the program itself follow the program name. For example:

```
% ruby -w - "Hello World"
```

will enable warnings, read a program from standard input, and pass it the quoted string `"Hello World"` as an argument.

---

1. This is the title of a marvelous essay by Neal Stephenson (available online at <http://www.spack.org/index.cgi/InTheBeginningWasTheCommandLine>).

## Command-Line Options

`-0[octal]`

The 0 flag (the digit zero) specifies the record separator character (`\0`, if no digit follows). `-00` indicates paragraph mode: records are separated by two successive default record separator characters. `-0777` reads the entire file at once (as it is an illegal character). Sets `$/`.

`-a` Autosplit mode when used with `-n` or `-p`; equivalent to executing `$F = $_.split` at the top of each loop iteration.

`-C directory`

Changes working directory to *directory* before executing.

`-c` Checks syntax only; does not execute the program.

`--copyright`

Prints the copyright notice and exits.

1.8

`-d, --debug`

Sets `$DEBUG` and `$VERBOSE` to true. This can be used by your programs to enable additional tracing.

`-e 'command'`

Executes *command* as one line of Ruby source. Several `-e`'s are allowed, and the commands are treated as multiple lines in the same program. If *programfile* is omitted when `-e` is present, execution stops after the `-e` commands have been run. Programs run using `-e` have access to the old behavior of ranges and regular expressions in conditions—ranges of integers compare against the current input line number, and regular expressions match against `$_`.

1.8

`-F pattern`

Specifies the input field separator (`$;`) used as the default for `split()` (affects the `-a` option).

`-h, --help`

Displays a short help screen.

`-I directories`

Specifies directories to be prepended to `$LOAD_PATH` (`$:`). Multiple `-I` options may be present. Multiple directories may appear following each `-I`, separated by a colon (`:`) on Unix-like systems and by a semicolon (`;`) on DOS/Windows systems.

`-i [extension]`

Edits ARGV files in place. For each file named in ARGV, anything you write to standard output will be saved back as the contents of that file. A backup copy of the file will be made if *extension* is supplied.

```
% ruby -pi.bak -e "gsub(/Perl/, 'Ruby')" *.txt
```

- K *kcode*  
Specifies the code set to be used. This option is useful mainly when Ruby is used for Japanese-language processing. *kcode* may be one of: e, E for EUC; s, S for SJIS; u, U for UTF-8; or a, A, n, N for ASCII.
- l Enables automatic line-ending processing; sets `$\` to the value of `$/` and chops every input line automatically.
- n Assumes a `while gets; ...; end` loop around your program. For example, a simple `grep` command could be implemented as
 

```
% ruby -n -e "print if /wombat/" *.txt
```
- p Places your program code within the loop `while gets; ...; print; end`.
 

```
% ruby -p -e "$_.downcase!" *.txt
```
- r *library*  
requires the named library before executing.
- S Looks for the program file using `RUBYPATH` or `PATH` environment variable.
- s Any command-line switches found after the program filename, but before any filename arguments or before a `--`, are removed from `ARGV` and set to a global variable named for the switch. In the following example, the effect of this would be to set the variable `$opt` to "electric".
 

```
% ruby -s prog -opt=electric ./mydata
```
- T[*level*]  
Sets the safe level, which among other things enables tainting checks (see page 379). Sets `SAFE`.
- 1.8 -v, `--verbose`  
Sets `VERBOSE` to true, which enables verbose mode. Also prints the version number. In verbose mode, compilation warnings are printed. If no program filename appears on the command line, Ruby exits.
- `--version`  
Displays the Ruby version number and exits.
- w Enables verbose mode. Unlike `-v`, reads program from standard input if no program files are present on the command line. We recommend running your Ruby programs with `-w`.  
1.8
- W *level*  
Sets the level of warnings issued. With a *level* or two (or with no level specified), equivalent to `-w`—additional warnings are given. If *level* is 1, runs at the standard (default) warning level. With `-W0` absolutely no warnings are given (including those issued using `Kernel.warn`).

- X *directory*  
Changes working directory to *directory* before executing. Same as -C *directory*.
- x [*directory*]  
Strips off text before `#!/ruby` line and changes working directory to *directory* if given.
- y, --yydebug  
Enables yacc debugging in the parser (*waaay too much information*).

## ARGV

Any command-line arguments after the program filename are available to your Ruby program in the global array ARGV. For instance, assume `test.rb` contains the following program:

```
ARGV.each {|arg| p arg }
```

Invoke it with the following command line:

```
% ruby -w test.rb "Hello World" a1 1.6180
```

It'll generate the following output:

```
"Hello World"
"a1"
"1.6180"
```

There's a gotcha here for all you C programmers—`ARGV[0]` is the first argument to the program, not the program name. The name of the current program is available in the global variable `$0`. Notice that all the values in ARGV are strings.

If your program attempts to read from standard input (or uses the special file ARGF, described on page 321), the program arguments in ARGV will be taken to be filenames, and Ruby will read from these files. If your program takes a mixture of arguments and filenames, make sure you empty the nonfilename arguments from the ARGV array before reading from the files.

## Program Termination

The method `Kernel#exit` terminates your program, returning a status value to the operating system. However, unlike some languages, `exit` doesn't terminate the program immediately. `Kernel#exit` first raises a `SystemExit` exception, which you may catch, and then performs a number of cleanup actions, including running any registered `at_exit` methods and object finalizers. See the reference for `Kernel#exit` beginning on page 500 for details.

## Environment Variables

You can access operating system environment variables using the predefined variable `ENV`. It responds to the same methods as `Hash`.<sup>2</sup>

```
ENV['SHELL'] → "/bin/sh"
ENV['HOME'] → "/Users/dave"
ENV['USER'] → "dave"
ENV.keys.size → 34
ENV.keys[0, 7] → ["MANPATH", "TERM_PROGRAM", "TERM", "SHELL",
 "SAVEHIST", "HISTSIZE", "MAKEFLAGS"]
```

The values of some environment variables are read by Ruby when it first starts. These variables modify the behavior of the interpreter, as shown in Table 14.1 on the next page.

## Writing to Environment Variables

A Ruby program may write to the `ENV` object. On most systems this changes the values of the corresponding environment variables. However, this change is local to the process that makes it and to any subsequently spawned child processes. This inheritance of environment variables is illustrated in the code that follows. A subprocess changes an environment variable, and this change is inherited by a process that it then starts. However, the change is not visible to the original parent. (This just goes to prove that parents never really know what their children are doing.)

```
puts "In parent, term = #{ENV['TERM']}"
fork do
 puts "Start of child 1, term = #{ENV['TERM']}"
 ENV['TERM'] = "ansi"
 fork do
 puts "Start of child 2, term = #{ENV['TERM']}"
 end
 Process.wait
 puts "End of child 1, term = #{ENV['TERM']}"
end
Process.wait
puts "Back in parent, term = #{ENV['TERM']}"
```

*produces:*

```
In parent, term = xterm-color
Start of child 1, term = xterm-color
Start of child 2, term = ansi
End of child 1, term = ansi
Back in parent, term = xterm-color
```

---

2. `ENV` is not actually a hash, but if you need to, you can convert it into a Hash using `ENV#to_hash`.

Table 14.1. Environment variables used by Ruby

| Variable Name           | Description                                                                                                                    |
|-------------------------|--------------------------------------------------------------------------------------------------------------------------------|
| DLN_LIBRARY_PATH        | Search path for dynamically loaded modules.                                                                                    |
| HOME                    | Points to user's home directory. Used when expanding ~ in file and directory names.                                            |
| LOGDIR                  | Fallback pointer to the user's home directory if \$HOME is not set. Used only by <code>Dir.chdir</code> .                      |
| <u>1.8</u> OPENSLL_CONF | Specify location of OpenSSL configuration file.                                                                                |
| RUBYLIB                 | Additional search path for Ruby programs (\$SAFE must be 0).                                                                   |
| RUBYLIB_PREFIX          | (Windows only) Mangle the RUBYLIB search path by adding this prefix to each component.                                         |
| RUBYOPT                 | Additional command-line options to Ruby; examined after real command-line options are parsed (\$SAFE must be 0).               |
| RUBYPATH                | With <code>-S</code> option, search path for Ruby programs (defaults to <code>PATH</code> ).                                   |
| RUBYSHELL               | Shell to use when spawning a process under Windows; if not set, will also check <code>SHELL</code> or <code>COMSPEC</code> .   |
| RUBY_TCL_DLL            | Override default name for TCL shared library or DLL.                                                                           |
| RUBY_TK_DLL             | Override default name for Tk shared library or DLL. Both this and <code>RUBY_TCL_DLL</code> must be set for either to be used. |

## Where Ruby Finds Its Modules

You use `require` or `load` to bring a library module into your Ruby program. Some of these modules are supplied with Ruby, some you may have installed off the Ruby Application Archive, and some you may have written yourself. How does Ruby find them?

When Ruby is built for your particular machine, it predefines a set of standard directories to hold library stuff. Where these are depends on the machine in question. You can determine this from the command line with something like

```
% ruby -e 'puts $:'
```

1.8 On a typical Linux box, you'll probably find something such as the following. Note that as of Ruby 1.8, the order of these directories has changed—architecture-specific directories now follow their machine-independent counterparts.

```
/usr/local/lib/ruby/site_ruby/1.8
/usr/local/lib/ruby/site_ruby/1.8/i686-linux
/usr/local/lib/ruby/site_ruby
/usr/local/lib/ruby/1.8
/usr/local/lib/ruby/1.8/i686-linux
.
```



The `site_ruby` directories are intended to hold modules and extensions that you've added. The architecture-dependent directories (`i686-linux` in this case) hold executables and other things specific to this particular machine. All these directories are automatically included in Ruby's search for modules.

Sometimes this isn't enough. Perhaps you're working on a large project written in Ruby, and you and your colleagues have built a substantial library of Ruby code. You want everyone on the team to have access to all this code. You have a couple of options to accomplish this. If your program runs at a safe level of zero (see Chapter 25 beginning on page 379), you can set the environment variable `RUBYLIB` to a list of one or more directories to be searched.<sup>3</sup> If your program is not *setuid*, you can use the command-line parameter `-I` to do the same thing.

The Ruby variable `$:` is an array of places to search for loaded files. As we've seen, this variable is initialized to the list of standard directories, plus any additional ones you specified using `RUBYLIB` and `-I`. You can always add additional directories to this array from within your running program.

Just to make things more interesting, a new way of organizing libraries came along just in time to make it into this book. Chapter 17 on page 203 describes `RubyGems`, a network-enabled package management system.

## Build Environment

When Ruby is compiled for a particular architecture, all the relevant settings used to build it (including the architecture of the machine on which it was compiled, compiler options, source code directory, and so on) are written to the module `Config` within the library file `rbconfig.rb`. After installation, any Ruby program can use this module to get details on how Ruby was compiled.

```
require 'rbconfig.rb'
include Config
CONFIG["host"] → "powerpc-apple-darwin7.5.0"
CONFIG["libdir"] → "/Users/dave/ruby1.8/lib"
```

Extension libraries use this configuration file in order to compile and link properly on any given architecture. See Chapter 21 beginning on page 261 and the reference for `mkmf` beginning on page 755 for details.

---

3. The separator between entries depends on your platform. For Windows, it's a semicolon; for Unix, it's a colon.

# Interactive Ruby Shell

---

Back on page 156 we introduced `irb`, a Ruby module that lets you enter Ruby programs interactively and see the results immediately. This chapter goes into more detail on using and customizing `irb`.

## Command Line

`irb` is run from the command line.

```
irb [irb-options] [ruby_script] [program arguments]
```

The command-line options for `irb` are listed in Table 15.1 on the next page. Typically, you'll run `irb` with no options, but if you want to run a script and watch the blow-by-blow description as it runs, you can provide the name of the Ruby script and any options for that script.

Once started, `irb` displays a prompt and waits for input. In the examples that follow, we'll use `irb`'s default prompt, which shows the current binding, the indent (nesting) level, and the line number.

At a prompt, you can type Ruby code. `irb` includes a Ruby parser, so it knows when statements are incomplete. When this happens, the prompt will end with an asterisk. You can leave `irb` by typing **exit** or **quit**, or by entering an end-of-file character (unless `IGNORE_EOF` mode is set).

```
% irb
irb(main):001:0> 1 + 2
=> 3
irb(main):002:0> 3 +
irb(main):003:0* 4
=> 7
irb(main):004:0> quit
%
```

Table 15.1. irb command-line options

| Option                                 | Description                                                                                                                                                                       |
|----------------------------------------|-----------------------------------------------------------------------------------------------------------------------------------------------------------------------------------|
| <code>--back-trace-limit n</code>      | Display backtrace information using the top <i>n</i> and last <i>n</i> entries. The default value is 16.                                                                          |
| <code>-d</code>                        | Set <code>\$DEBUG</code> to true (same as <code>ruby -d</code> ).                                                                                                                 |
| <code>-f</code>                        | Suppress reading <code>~/ .irbrc</code> .                                                                                                                                         |
| <code>-I path</code>                   | specify the <code>\$LOAD_PATH</code> directory.                                                                                                                                   |
| <code>--inf-ruby-mode</code>           | Set up irb to run in <code>inf-ruby-mode</code> under Emacs. Change the prompt and suppress <code>--readline</code> .                                                             |
| <code>--inspect</code>                 | Use <code>Object#inspect</code> to format output (the default, unless in math mode).                                                                                              |
| <code>--irb_debug n</code>             | Set internal debug level to <i>n</i> (only useful for irb development).                                                                                                           |
| <code>-m</code>                        | Math mode (fraction and matrix support is available).                                                                                                                             |
| <code>--noinspect</code>               | Do not use inspect for output.                                                                                                                                                    |
| <code>--noprompt</code>                | Do not display a prompt.                                                                                                                                                          |
| <code>--noreadline</code>              | Do not use Readline extension module.                                                                                                                                             |
| <code>--prompt prompt-mode</code>      | Switch prompt. Predefined prompt modes are <code>null</code> , <code>default</code> , <code>classic</code> , <code>simple</code> , <code>xmp</code> , and <code>inf-ruby</code> . |
| <code>--prompt-mode prompt-mode</code> | Same as <code>--prompt</code> .                                                                                                                                                   |
| <code>-r load-module</code>            | Same as <code>ruby -r</code> .                                                                                                                                                    |
| <code>--readline</code>                | Use readline extension module.                                                                                                                                                    |
| <code>--simple-prompt</code>           | Use simple prompts.                                                                                                                                                               |
| <code>--tracer</code>                  | Display trace for execution of commands.                                                                                                                                          |
| <code>-v, --version</code>             | Print the version of irb.                                                                                                                                                         |

During an irb session, the work you do is accumulated in irb's workspace. Variables you set, methods you define, and classes you create are all remembered and may be used subsequently.

```

irb(main):001:0> def fib_up_to(n)
irb(main):002:1> f1, f2 = 1, 1
irb(main):003:1> while f1 <= n
irb(main):004:2> puts f1
irb(main):005:2> f1, f2 = f2, f1+f2
irb(main):006:2> end
irb(main):007:1> end
=> nil
irb(main):008:0> fib_up_to(4)
1
1
2
3
=> nil

```

Notice the `nil` return values. These are the results of defining the method and then running it. The method output the Fibonacci numbers but then returned `nil`.

A great use of `irb` is experimenting with code you've already written. Perhaps you want to track down a bug, or maybe you just want to play. If you load your program into `irb`, you can then create instances of the classes it defines and invoke its methods. For example, the file `code/fib_up_to.rb` contains the following method definition.

```
def fib_up_to(max)
 i1, i2 = 1, 1
 while i1 <= max
 yield i1
 i1, i2 = i2, i1+i2
 end
end
```

We can load this into `irb` and play with the method.

```
% irb
irb(main):001:0> load 'code/fib_up_to.rb'
=> true
irb(main):002:0> result = []
=> []
irb(main):003:0> fib_up_to(20) {|val| result << val}
=> nil
irb(main):004:0> result
=> [1, 1, 2, 3, 5, 8, 13]
```

In this example, we use `load`, rather than `require`, to include the file in our session. We do this as a matter of practice: `load` allows us to load the same file multiple times, so if we find a bug and edit the file, we could reload it into our `irb` session.

## Tab Completion

If your Ruby installation has `readline` support, then you can use `irb`'s completion facility. Once loaded (and we'll get to how to load it shortly), completion changes the meaning of the `TAB` key when typing expressions at the `irb` prompt. When you press `TAB` partway through a word, `irb` will look for possible completions that make sense at that point. If there is only one, `irb` will fill it in automatically. If there's more than one valid option, `irb` initially does nothing. However, if you hit `TAB` again, it will display the list of valid completions at that point.

For example, you may be in the middle of an `irb` session, having just assigned a string object to the variable `a`.

```
irb(main):002:0> a = "cat"
=> "cat"
```

You now want to try the method `String#reverse` on this object. You start by typing `a.reverse` and then hit `TAB` twice.

```

irb(main):003:0> a.re[TAB][TAB]
a.reject a.replace a.respond_to? a.reverse a.reverse!

```

irb lists all the methods supported by the object in a whose names start with “re.” We see the one we want, reverse, and enter the next character of its name, v, followed by the `[TAB]` key.

```

irb(main):003:0> a.rev[TAB]
irb(main):003:0> a.reverse
=> "tac"
irb(main):004:0>

```

irb responds to the `[TAB]` key by expanding the name as far as it can go, in this case completing the word reverse. If we keyed `[TAB]` twice at this point, it would show us the current options, reverse and reverse!. However, as reverse is the one we want, we instead hit `[ENTER]`, and the line of code is executed.

Tab completion isn’t limited to built-in names. If we define a class in irb, then tab completion works when we try to invoke one of its methods.

```

irb(main):004:0> class Test
irb(main):005:1> def my_method
irb(main):006:2> end
irb(main):007:1> end
=> nil
irb(main):008:0> t = Test.new
=> #<Test:0x35b724>
irb(main):009:0> t.my[TAB]
irb(main):009:0> t.my_method

```

Tab completion is implemented as an extension library, `irb/completion`. You can load it when you invoke irb from the command line.

```
% irb -r irb/completion
```

You can also load the completion library when irb is running.

```

irb(main):001:0> require 'irb/completion'
=> true

```

If you use tab completion all the time, it’s probably most convenient to put the require command into your `.irbrc` file.

```
require 'irb/completion'
```

## Subsessions

irb supports multiple, concurrent sessions. One is always current; the others lie dormant until activated. Entering the command `irb` within irb creates a subsession, entering the `jobs` command lists all sessions, and entering `fg` activates a particular dormant session.

This example also illustrates the `-r` command-line option, which loads in the given file before `irb` starts.

```
% irb -r code/fib_up_to.rb
irb(main):001:0> result = []
=> []
irb(main):002:0> fib_up_to(10) {|val| result << val }
=> nil
irb(main):003:0> result
=> [1, 1, 2, 3, 5, 8]
irb(main):004:0> # Create a nested irb session
irb(main):005:0* irb
irb#1(main):001:0> result = %w{ cat dog horse }
=> ["cat", "dog", "horse"]
irb#1(main):002:0> result.map {|val| val.upcase }
=> ["CAT", "DOG", "HORSE"]
irb#1(main):003:0> jobs
=> #0->irb on main (#<Thread:0x331740>: stop)
#1->irb#1 on main (#<Thread:0x341694>: running)
irb#1(main):004:0> fg 0
irb(main):006:0> result
=> [1, 1, 2, 3, 5, 8]
irb(main):007:0> fg 1
irb#1(main):005:0> result
=> ["cat", "dog", "horse"]
```

## Subsessions and Bindings

If you specify an object when you create a subsession, that object becomes the value of *self* in that binding. This is a convenient way to experiment with objects. In the following example, we create a subsession with the string “wombat” as the default object. Methods with no receiver will be executed by that object.

```
% irb
irb(main):001:0> self
=> main
irb(main):002:0> irb "wombat"
irb#1(wombat):001:0> self
=> "wombat"
irb#1(wombat):002:0> upcase
=> "WOMBAT"
irb#1(wombat):003:0> size
=> 6
irb#1(wombat):004:0> gsub(/[aeiou]/, '*')
=> "w*mb*t"
irb#1(wombat):005:0> irb_exit
irb(main):003:0> self
=> main
irb(main):004:0> upcase
NameError: undefined local variable or method `upcase' for main:Object
```

# Configuration

`irb` is remarkably configurable. You can set configuration options with command-line options, from within an initialization file, and while you're inside `irb` itself.

## Initialization File

`irb` uses an initialization file in which you can set commonly used options or execute any required Ruby statements. When `irb` is run, it will try to load an initialization file from one of the following sources in order: `~/ .irbrc`, `.irbrc`, `irb.rc`, `_irbrc`, and `$irbrc`.

Within the initialization file you may run any arbitrary Ruby code. You can also set configuration values. The list of configuration variables is given starting on page 181—the values that can be used in an initialization file are the symbols (starting with a colon). You use these symbols to set values into the `IRB.conf` hash. For example, to make `SIMPLE` the default prompt for all your `irb` sessions, you could have the following in your initialization file.

```
IRB.conf[:PROMPT_MODE] = :SIMPLE
```

As an interesting twist on configuring `irb`, you can set `IRB.conf[:IRB_RC]` to a `Proc` object. This `proc` will be invoked whenever the `irb` context is changed and will receive the configuration for that context as a parameter. You can use this facility to change the configuration dynamically based on the context. For example, the following `.irbrc` file sets the prompt so that only the main prompt shows the `irb` level, but continuation prompts and the result still line up.

```
IRB.conf[:IRB_RC] = proc do |conf|
 leader = " " * conf.irb_name.length
 conf.prompt_i = "#{conf.irb_name} --> "
 conf.prompt_s = leader + ' \-' '
 conf.prompt_c = leader + ' \-+ '
 conf.return_format = leader + " ==> %s\n\n"
 puts "Welcome!"
end
```

An `irb` session using this `.irbrc` file looks like the following.

```
% irb
Welcome!
irb --> 1 + 2
 ==> 3

irb --> 2 +
 \-+ 6
 ==> 8
```

## Extending irb

Because the things you type to irb are interpreted as Ruby code, you can effectively extend irb by defining new top-level methods. For example, you may want to be able to look up the documentation for a class or method while in irb. If you add the following to your `.irbrc` file, you'll add a method called `ri`, which invokes the external `ri` command on its arguments.

```
def ri(*names)
 system(%{ri #{names.map {|name| name.to_s}.join(" ")}})
end
```

The next time you start irb, you'll be able to use this method to get documentation.

```
irb(main):001:0> ri Proc
----- Class: Proc
Proc objects are blocks of code that have been bound to a set of
local variables. Once bound, the code may be called in different
contexts and still access those variables.
and so on...

irb(main):002:0> ri :strftime
----- Time#strftime
time.strftime(string) => string

Formats time according to the directives in the given format
string. Any text not listed as a directive will be passed through
to the output string.

Format meaning:
%a - The abbreviated weekday name (`Sun')
%A - The full weekday name (`Sunday')
%b - The abbreviated month name (`Jan')
%B - The full month name (`January')
%c - The preferred local date and time representation
%d - Day of the month (01..31)
and so on...

irb(main):003:0> ri "String.each"
----- String#each
str.each(separator=$/) |substr| block => str
str.each_line(separator=$/) |substr| block => str

Splits str using the supplied parameter as the record separator
($/ by default), passing each substring in turn to the supplied
block. If a zero-length record separator is supplied, the string
is split on \n characters, except that multiple successive
newlines are appended together.

print "Example one\n"
"hello\nworld".each |s| p s
and so on...
```



## Interactive Configuration

Most configuration values are also available while you're running `irb`. The list starting on the current page shows these values as `conf.xxx`. For example, to change your prompt back to `DEFAULT`, you could use the following.

```
irb(main):001:0> 1 +
irb(main):002:0* 2
=> 3
irb(main):003:0> conf.prompt_mode = :SIMPLE
=> :SIMPLE
>> 1 +
?> 2
=> 3
```

## irb Configuration Options

In the descriptions that follow, a label of the form `:XXX` signifies a key used in the `IRB.conf` hash in an initialization file, and `conf.xxx` signifies a value that can be set interactively. The value in square brackets at the end of the description is the option's default.

### **:AUTO\_INDENT / conf.auto\_indent\_mode**

If true, `irb` will indent nested structures as you type them. [false]

### **:BACK\_TRACE\_LIMIT / conf.back\_trace\_limit**

Displays lines  $n$  initial and  $n$  final lines of backtrace. [16]

### **:CONTEXT\_MODE**

What binding to use for new workspaces: 0→ `proc` at the top level, 1→ binding in a loaded, anonymous file, 2→ per thread binding in a loaded file, 3→ binding in a top-level function. [3]

### **:DEBUG\_LEVEL / conf.debug\_level**

Sets the internal debug level to  $n$ . Useful if you're debugging `irb`'s lexer. [0]

### **:IGNORE\_EOF / conf.ignore\_eof**

Specifies the behavior of an end of file received on input. If true, it will be ignored; otherwise, `irb` will quit. [false]

### **:IGNORE\_SIGINT / conf.ignore\_sigint**

If false, `^C` (Ctrl+c) will quit `irb`. If true, `^C` during input will cancel input and return to the top level; during execution, `^C` will abort the current operation. [true]

### **:INSPECT\_MODE / conf.inspect\_mode**

Specifies how values will be displayed: `true` means use `inspect`, `false` uses `to_s`, and `nil` uses `inspect` in nonmath mode and `to_s` in math mode. [nil]

**:IRB\_RC**

Can be set to a proc object that will be called when an irb session (or subsession) is started.  
[nil]

**conf.last\_value**

The last value output by irb. [...]

**:LOAD\_MODULES / conf.load\_modules**

A list of modules loaded via the `-r` command-line option. [[]]

**:MATH\_MODE / conf.math\_mode**

If true, irb runs with the `mathn` library loaded (see page 671). [false]

**conf.prompt\_c**

The prompt for a continuing statement (for example, immediately after an “if”). [depends]

**conf.prompt\_i**

The standard, top-level prompt. [depends]

**:PROMPT\_MODE / conf.prompt\_mode**

The style of prompt to display. [:DEFAULT]

**conf.prompt\_s**

The prompt for a continuing string. [depends]

**:PROMPT**

See *Configuring the Prompt* on page 184. [{ ... }]

**:RC / conf.rc**

If false, do not load an initialization file. [true]

**conf.return\_format**

The format used to display the results of expressions entered interactively. [depends]

**:SINGLE\_IRB**

If true, nested irb sessions will all share the same binding; otherwise a new binding will be created according to the value of `:CONTEXT_MODE`. [nil]

**conf.thread**

A read-only reference to the currently executing Thread object. [current thread]

**:USE\_LOADER / conf.use\_loader**

Specifies whether irb’s own file reader method is used with `load/require`. [false]

**:USE\_READLINE / conf.use\_readline**

irb will use the `readline` library if available (see page 702) unless this option is set to false, in which case `readline` will never be used, or `nil`, in which case `readline` will not be used in `inf-ruby-mode`. [depends]

**:USE\_TRACER / conf.use\_tracer**

If true, traces the execution of statements. [false]

**:VERBOSE / conf.verbose**

In theory switches on additional tracing when true; in practice almost no extra tracing results. [true]

## Commands

At the irb prompt, you can enter any valid Ruby expression and see the results. You can also use any of the following commands to control the irb session.

**exit, quit, irb\_exit, irb\_quit**

Quits this irb session or subsession. If you've used `cb` to change bindings (see below), exits from this binding mode.

**conf, context, irb\_context**

Displays current configuration. Modifying the configuration is achieved by invoking methods of `conf`. The list starting on page 181 shows the available `conf` settings. For example, to set the default prompt to something subservient, you could use

```
irb(main):001:0> conf.prompt_i = "Yes, Master? "
=> "Yes, Master? "
Yes, Master? 1 + 2
```

**cb, irb\_change\_binding** `< obj >`

Creates and enters a new binding that has its own scope for local variables. If *obj* is given, it will be used as `self` in the new binding.

**irb** `< obj >`

Starts an irb subsession. If *obj* is given, it will be used as `self`.

**jobs, irb\_jobs**

Lists irb subsessions.

**fg** *n*, **irb\_fg** *n*

Switches into the specified irb subsession. *n* may be any of: an irb session number, a thread ID, an irb object, or the object that was the value of `self` when a subsession was launched.

**kill** *n*, **irb\_kill** *n*

Kills an irb subsession. *n* may be any of the values as described for `irb_fg`.

## Configuring the Prompt

You have a lot of flexibility in configuring the prompts that `irb` uses. Sets of prompts are stored in the prompt hash, `IRB.conf[:PROMPT]`.

For example, to establish a new prompt mode called “MY\_PROMPT”, you could enter the following (either directly at an `irb` prompt or in the `.irbrc` file).

```
IRB.conf[:PROMPT][:MY_PROMPT] = { # name of prompt mode
 :PROMPT_I => '-->', # normal prompt
 :PROMPT_S => '--"', # prompt for continuing strings
 :PROMPT_C => '--+', # prompt for continuing statement
 :RETURN => " ==>%s\n" # format to return value
}
```

Once you’ve defined a prompt, you have to tell `irb` to use it. From the command line, you can use the `--prompt` option. (Notice how the name of the prompt mode is automatically converted to uppercase, with hyphens changing to underscores.)

```
% irb --prompt my-prompt
```

If you want to use this prompt in all your future `irb` sessions, you can set it as a configuration value in your `.irbrc` file.

```
IRB.conf[:PROMPT_MODE] = :MY_PROMPT
```

The symbols `PROMPT_I`, `PROMPT_S`, and `PROMPT_C` specify the format for each of the prompt strings. In a format string, certain “%” sequences are expanded.

| Flag | Description                                                                                                                                                                                                      |
|------|------------------------------------------------------------------------------------------------------------------------------------------------------------------------------------------------------------------|
| %N   | Current command.                                                                                                                                                                                                 |
| %m   | <code>to_s</code> of the main object (self).                                                                                                                                                                     |
| %M   | <code>inspect</code> of the main object (self).                                                                                                                                                                  |
| %l   | Delimiter type. In strings that are continued across a line break, %l will display the type of delimiter used to begin the string, so you’ll know how to end it. The delimiter will be one of “, ’, /, ], or `”. |
| %ni  | Indent level. The optional number <i>n</i> is used as a width specification to <code>printf</code> , as <code>printf("%nd")</code> .                                                                             |
| %nn  | Current line number ( <i>n</i> used as with the indent level).                                                                                                                                                   |
| %%   | A literal percent sign.                                                                                                                                                                                          |

For instance, the default prompt mode is defined as follows.

```
IRB.conf[:PROMPT_MODE][:DEFAULT] = {
 :PROMPT_I => "%N(%m):%03n:%i> ",
 :PROMPT_S => "%N(%m):%03n:%i%l ",
 :PROMPT_C => "%N(%m):%03n:%i* ",
 :RETURN => "%s\n"
}
```

## Restrictions

Because of the way `irb` works, it is slightly incompatible with the standard Ruby interpreter. The problem lies in the determination of local variables.

Normally, Ruby looks for an assignment statement to determine if something is a variable—if a name hasn't been assigned to, then Ruby assumes that name is a method call.

```
eval "var = 0"
var
```

*produces:*

```
prog.rb:2: undefined local variable or method `var'
for main:Object (NameError)
```

In this case, the assignment is there, but it's within a string, so Ruby doesn't take it into account.

`irb`, on the other hand, executes statements as they are entered.

```
irb(main):001:0> eval "var = 0"
0
irb(main):002:0> var
0
```

In `irb`, the assignment was executed before the second line was encountered, so `var` is correctly identified as a local variable.

If you need to match the Ruby behavior more closely, you can place these statements within a `begin/end` pair.

```
irb(main):001:0> begin
irb(main):002:1* eval "var = 0"
irb(main):003:1> var
irb(main):004:1> end
NameError: undefined local variable or method `var'
(irb):3:in `irb_binding'
```

## rtags and xmp

Just in case `irb` wasn't already complex enough, let's add a few more wrinkles. Along with the main `irb` program, the `irb` suite includes some extra goodies. In the next sections we'll look at two: `rtags` and `xmp`.

### rtags

`rtags` is a command used to create a TAGS file for use with either the Emacs or vi editor.

```
rtags [-vi] [files]...
```

By default, `rtags` makes a TAGS file suitable for Emacs (see `etags.el`). The `-vi` option makes a TAGS file for use with `vi`.

`rtags` needs to be installed in the same manner as `irb` (that is, you need to install `irb` in the library path and make a link from `irb/rtags.rb` to `bin/rtags`).

## xmp

`irb`'s `xmp` is an “example printer”—that is, a pretty-printer that shows the value of each expression as it is run (much like the script we wrote to format the examples in this book). There is also another stand-alone `xmp` in the archives.

`xmp` can be used as follows.

```
require 'irb/xmp'
xmp <<END
artist = "Doc Severinsen"
artist.upcase
END
```

*produces:*

```
artist = "Doc Severinsen"
==> "Doc Severinsen"
artist.upcase
==> "DOC SEVERINSEN"
```

Or, `xmp` can be used as an object instance. Used in this fashion, the object maintains context between invocations.

```
require 'irb/xmp'
x = XMP.new
x.puts 'artist = "Louis Prima"'
x.puts 'artist.upcase'
```

*produces:*

```
artist = "Louis Prima"
==> "Louis Prima"
artist.upcase
==> "LOUIS PRIMA"
```

You can explicitly provide a binding with either form; otherwise, `xmp` uses the caller's environment.

```
xmp code_string, abinding
XMP.new(abinding)
```

Note that `xmp` does not work with multithreading.

# Documenting Ruby

---

1.8

As of version 1.8, Ruby comes bundled with RDoc, a tool that extracts and formats documentation that's embedded in Ruby source code files. This tool is used to document the built-in Ruby classes and modules. An increasing number of libraries and extensions are also documented this way.

RDoc does two jobs. First, it analyzes Ruby and C source files, looking for information to document.<sup>1</sup> Second, it takes this information and converts it into something readable. Out of the box, RDoc produces two kinds of output: HTML and ri. Figure 16.1 on the following page shows some HTML-format RDoc output in a browser window. This is the result of feeding RDoc a Ruby source file with no additional documentation—RDoc does a credible job of producing something meaningful. If our source code contains comments, RDoc can use them to spice up the documentation it produces. Typically, the comment before an element is used to document that element, as shown in Figure 16.2 on page 189.

RDoc can also be used to produce documentation that can be read by the ri command-line utility. For example, if we ask RDoc to document the code in Figure 16.2 this way, we can then access the documentation using ri, as shown in Figure 16.3 on page 190. New Ruby distributions have the built-in classes and modules (and some libraries) documented this way. Figure 16.4 on page 191 shows the output produced if you type **ri Proc**.

## Adding RDoc to Ruby Code

RDoc parses Ruby source files to extract the major elements (classes, modules, methods, attributes, and so on). You can choose to associate additional documentation with these by simply adding a comment block before the element in the file.

---

1. RDoc can also document Fortran 77 programs.

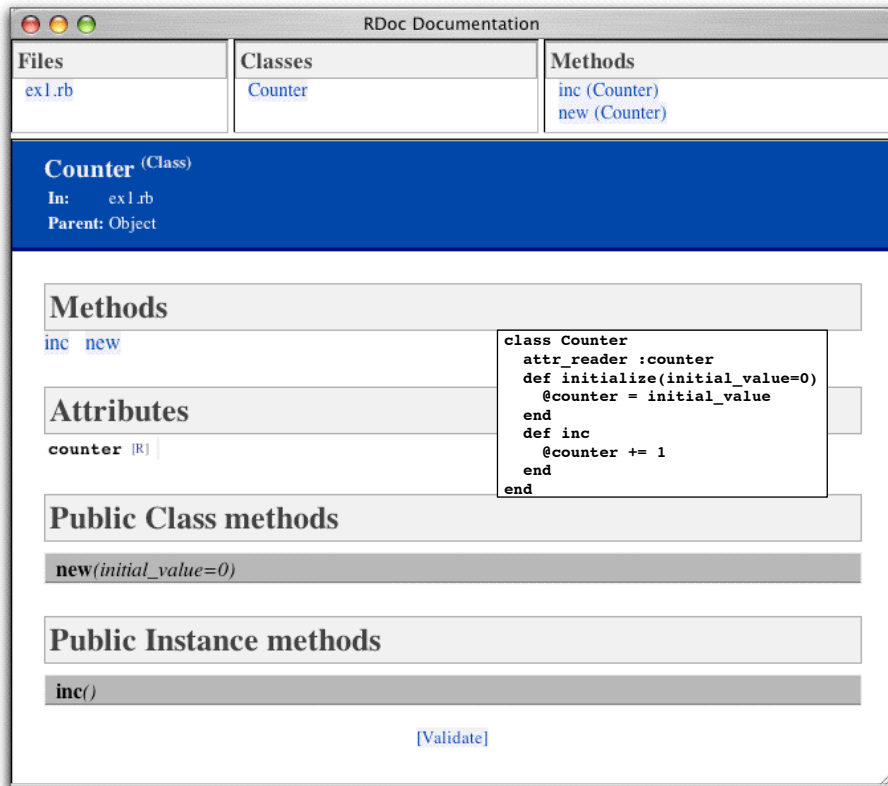

This figure shows some RDoc output in a browser window. The overlaid box shows the source program from which this output was generated. Even though the source contains no internal documentation, RDoc still manages to extract interesting information from it. We have three panes at the top of the screen showing the files, classes, and methods for which we have documentation. For class Counter, RDoc shows us the attributes and methods (including the method signatures). And if we clicked a method signature, RDoc would pop up a window containing the source code for the corresponding method.

Figure 16.1. Browse RDoc output for class counter



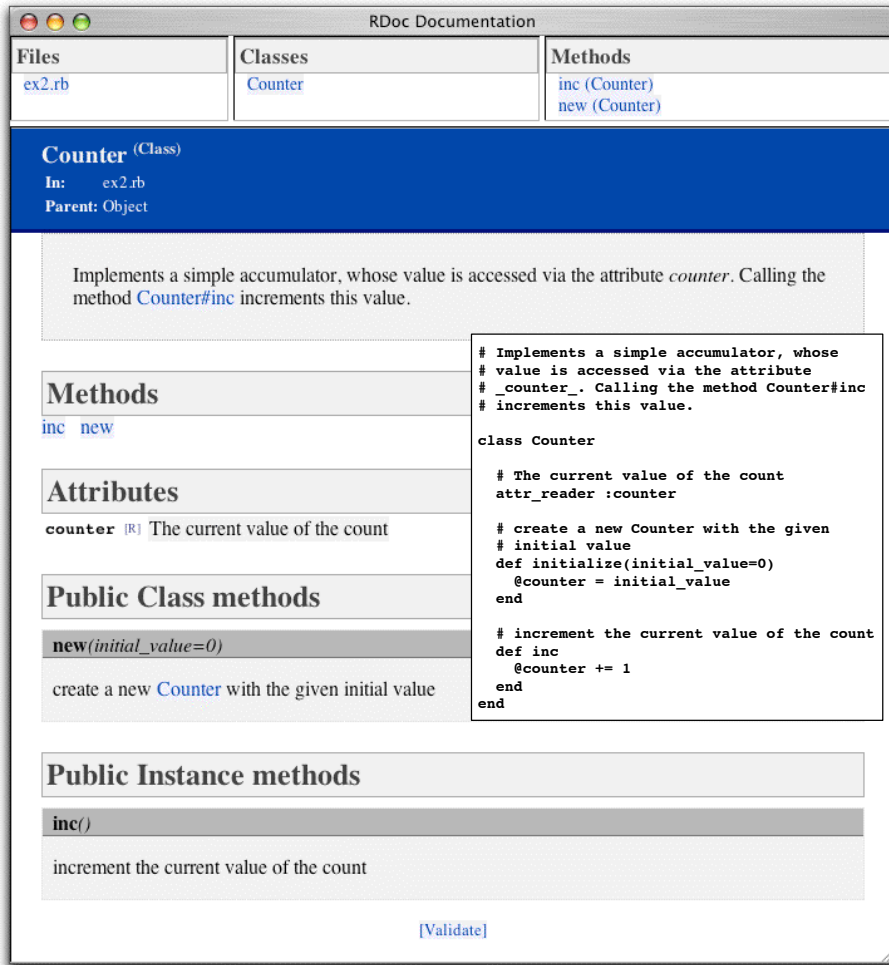

Notice how the comments before each element now appear in the RDoc output, reformatted into HTML. Less obvious is that RDoc has detected hyperlink opportunities in our comments: in the class-level comment, the reference to `Counter#inc` is a hyperlink to the method description, and in the command for the `new` method, the reference to class `Counter` hyperlinks back to the class documentation. This is a key feature of RDoc: it is designed to be unintrusive in the Ruby source files and to make up for this by trying to be clever when producing output.

Figure 16.2. Browse RDoc output when source has comments

Figure 16.3. Using ri to read documentation

```

% ri Counter
----- Class: Counter
 Implements a simple accumulator, whose value is
 accessed via the attribute counter. Calling the
 method Counter#inc increments this value.

Class methods:
 new

Instance methods:
 inc

Attributes:
 counter

% ri Counter.inc
----- Counter#inc
 inc()

 increment the current value of the count

```

Comment blocks can be written fairly naturally, either using # on successive lines of the comment or by including the comment in a =begin...=end block. If you use the latter form, the =begin line must be flagged with an rdoc tag, to distinguish the block from other styles of documentation.

```

=rdoc
Calculate the minimal-cost path though the graph
using Debrinkski's algorithm, with optimized
inverse pruning of isolated leaf nodes.
=end
def calculate_path
 . . .
end

```

Within a documentation comment, paragraphs are lines that share the left margin. Text indented past this margin is formatted verbatim.

Nonverbatim text can be marked up. To set individual words in italic, bold, or typewriter fonts, you can use `_word_`, `*word*`, and `+word+` respectively. If you want to do this to multiple words, or text containing non-word characters, you can use `<em>multiple words</em>`, `<b>more words</b>`, and `<tt>yet more words</tt>`. Putting a backslash before inline markup stops it being interpreted.

Figure 16.4. Document for class Proc generated by RDoc/ri

```

% ri Proc
----- Class: Proc
Proc objects are blocks of code that have been
bound to a set of local variables. Once bound,
the code may be called in different contexts and
still access those variables.

 def gen_times(factor)
 return Proc.new |n| n*factor
 end

 times3 = gen_times(3)
 times5 = gen_times(5)

 times3.call(12) #=> 36
 times5.call(5) #=> 25
 times3.call(times5.call(4)) #=> 60

Class methods:
 new

Instance methods:
 ==, [], arity, binding, call, clone, eql?, hash,
 to_proc, to_s

```

RDoc stops processing comments if it finds a comment line starting `#--`. This can be used to separate external from internal comments or to stop a comment being associated with a method, class, or module. Documenting can be turned back on by starting a line with `#++`.

```

Extract the age and calculate the
date of birth.
#--
FIXME: fails if the birthday falls on
February 29th, or if the person
was born before epoch and the installed
Ruby doesn't support negative time_t
#++
The DOB is returned as a Time object.
#--
But should probably change to use Date.
def get_dob(person)
 ...
end

```

## Hyperlinks

Names of classes, source files, and any method names containing an underscore or preceded by a hash character are automatically hyperlinked from comment text to their description.

Hyperlinks to the 'net starting `http:`, `mailto:`, `ftp:`, and `www:` are recognized. An HTTP URL that references an external image file is converted into an inline `<IMG...>` tag. Hyperlinks starting `link:` are assumed to refer to local files whose paths are relative to the `--op` directory, where output files are stored.

Hyperlinks can also be of the form `label[url]`, in which case the label is used in the displayed text and `url` is used as the target. If the label contains multiple words, surround it in braces: `{two words}[url]`.

## Lists

Lists are typed as indented paragraphs with

- a `*` or `-` (for bullet lists),
- a digit followed by a period for numbered lists,
- an uppercase or lowercase letter followed by a period for alpha lists.

For example, you could produce something like the previous text with

```
Lists are typed as indented paragraphs with:
* a '*' or '-' (for bullet lists)
* a digit followed by a period for
numbered lists
* an upper or lower case letter followed
by a period for alpha lists.
```

Note how subsequent lines in a list item are indented to line up with the text in the element's first line.

Labeled lists (sometimes called *description lists*) are typed using square brackets for the label.

```
[cat] small domestic animal
[+cat+] command to copy standard input
to standard output
```

Labeled lists may also be produced by putting a double colon after the label. This sets the result in tabular form, so the descriptions all line up.

```
cat:: small domestic animal
+cat+:: command to copy standard input
to standard output
```

For both kinds of labeled lists, if the body text starts on the same line as the label, then the start of that text determines the block indent for the rest of the body. The text may also start on the line following the label, indented from the start of the label. This is often preferable if the label is long. Both the following are valid labeled list entries

```
<tt>--output</tt> <i>name [, name]</i>::
specify the name of one or more output files. If multiple
files are present, the first is used as the index.
#
<tt>--quiet:</tt>:: do not output the names, sizes, byte counts,
index areas, or bit ratios of units as
they are processed.
```

## Headings

Headings are entered on lines starting with equals signs. The more equals signs, the higher the level of heading.

```
= Level One Heading
== Level Two Heading
and so on...
```

Rules (horizontal lines) are entered using three or more hyphens.

```
and so it goes...

The next section...
```

## Documentation Modifiers

Method parameter lists are extracted and displayed with the method description. If a method calls `yield`, then the parameters passed to `yield` will also be displayed. For example, consider the following code.

```
def fred
 ...
 yield line, address
```

This will get documented as:

```
fred() {|line, address| ... }
```

You can override this using a comment containing `:yields: ...` on the same line as the method definition.

```
def fred # :yields: index, position
 ...
 yield line, address
```

which will get documented as

```
fred() {|index, position| ... }
```

`:yields:` is an example of a documentation modifier. These appear immediately after the start of the document element they are modifying.

Other modifiers include

`:nodoc:` *[all]*

Don't include this element in the documentation. For classes and modules, the methods, aliases, constants, and attributes directly within the affected class or module will also be omitted from the documentation. By default, though, modules and classes within that class or module will be documented. This is turned off by adding the `all` modifier. For example, in the following code, only class `SM::Input` will be documented.

```
module SM #:nodoc:
 class Input
 end
end
module Markup #:nodoc: all
 class Output
 end
end
```

`:doc:`

Force a method or attribute to be documented even if it wouldn't otherwise be. Useful if, for example, you want to include documentation of a particular private method.

`:notnew:`

(Only applicable to the `initialize` instance method.) Normally RDoc assumes that the documentation and parameters for `#initialize` are actually for the corresponding class's `new` method and so fakes out a new method for the class. The `:notnew:` modifier stops this. Remember that `#initialize` is protected, so you won't see the documentation unless you use the `-a` command-line option.

## Other Directives

Comment blocks can contain other directives.

`:call-seq:` *lines...*

Text up to the next blank comment line is used as the calling sequence when generating documentation (overriding the parsing of the method parameter list). A line is considered blank even if it starts with a `#`. For this one directive, the leading colon is optional.

`:include:` *filename*

Include the contents of the named file at this point. The file will be searched for in the directories listed by the `--include` option or in the current directory by

default. The contents of the file will be shifted to have the same indentation as the `:` at the start of the `:include:` directive.

`:title:` *text*

Sets the title for the document. Equivalent to the `--title` command-line parameter. (The command-line parameter overrides any `:title:` directive in the source.)

`:main:` *name*

Equivalent to the `--main` command-line parameter, setting the initial page displayed for this documentation.

`:stopdoc:` / `:startdoc:`

Stop and start adding new documentation elements to the current container. For example, if a class has a number of constants that you don't want to document, put a `:stopdoc:` before the first and a `:startdoc:` after the last. If you don't specify a `:startdoc:` by the end of the container, disables documentation for the entire class or module.

`:enddoc:`

Document nothing further at the current lexical level.

Figure 16.5 on the following page shows a more complete example of a source file documented using RDoc.

## Adding RDoc to C Extensions

RDoc also understands many of the conventions used when writing extensions to Ruby in C.

Most C extensions have an `Init_Classname` function. RDoc takes this as the class definition—any C comment before the `Init_` method will be used as the class's documentation.

The `Init_` function is normally used to associate C functions with Ruby method names. For example, a `Cipher` extension may define a Ruby method `salt=`, implemented by the C function `salt_set` using a call such as

```
rb_define_method(cCipher, "salt=", salt_set, 1);
```

RDoc parses this call, adding the `salt=` method to the class documentation. RDoc then searches the C source for the C function `salt_set`. If this function is preceded by a comment block, RDoc uses this for the method's documentation.

This basic scheme works with no effort on your part beyond writing the normal documentation in the comments for functions. However, RDoc cannot discern the calling sequence for the corresponding Ruby method. In this example, the RDoc output will

Figure 16.5. Ruby source file documented with RDoc

```

This module encapsulates functionality related to the
generation of Fibonacci sequences.
#--
Copyright (c) 2004 Dave Thomas, The Pragmatic Programmers, LLC.
Licensed under the same terms as Ruby. No warranty is provided.
module Fibonacci

 # Calculate the first _count_ Fibonacci numbers, starting with 1,1.
 #
 # :call-seq:
 # Fibonacci.sequence(count) -> array
 # Fibonacci.sequence(count) {|val| ... } -> nil
 #
 # If a block is given, supply successive values to the block and
 # return +nil+, otherwise return all values as an array.
 def Fibonacci.sequence(count, &block)
 result, block = setup_optional_block(block)
 generate do |val|
 break if count <= 0
 count -= 1
 block[val]
 end
 result
 end

 # Calculate the Fibonacci numbers up to and including _max_.
 #
 # :call-seq:
 # Fibonacci.upto(count) -> array
 # Fibonacci.upto(count) {|val| ... } -> nil
 #
 # If a block is given, supply successive values to the
 # block and return +nil+, otherwise return all values as an array.
 def Fibonacci.upto(max, &block)
 result, block = setup_optional_block(block)
 generate do |val|
 break if val > max
 block[val]
 end
 result
 end

 private

 # Yield a sequence of Fibonacci numbers to a block.
 def Fibonacci.generate
 f1, f2 = 1, 1
 loop do
 yield f1
 f1, f2 = f2, f1+f2
 end
 end

 # If a block parameter is given, use it, otherwise accumulate into an
 # array. Return the result value and the block to use.
 def Fibonacci.setup_optional_block(block)
 if block.nil?
 [result = [], lambda {|val| result << val }]
 else
 [nil, block]
 end
 end
end
end

```



show a single argument with the (somewhat meaningless) name “arg1.” You can override this using the `call-seq` directive in the function’s comment. The lines following `call-seq` (up to a blank line) are used to document the calling sequence of the method.

```
/*
 * call-seq:
 * cipher.salt = number
 * cipher.salt = "string"
 *
 * Sets the salt of this cipher to either a binary +number+ or
 * bits in +string+.
 */
static VALUE
salt_set(cipher, salt)
...

```

If a method returns a meaningful value, it should be documented in the `call-seq` following the characters `->`.

```
/*
 * call-seq:
 * cipher.keylen -> Fixnum or nil
 */

```

Although RDoc heuristics work well for finding the class and method comments for simple extensions, it doesn’t always work for more complex implementations. In these cases, you can use the directives `Document-class:` and `Document-method:` to indicate that a C comment relates to a given class or method, respectively. The modifiers take the name of the Ruby class or method that’s being documented.

```
/*
 * Document-method: reset
 *
 * Clear the current buffer and prepare to add new
 * cipher text. Any accumulated output cipher text
 * is also cleared.
 */

```

Finally, it is possible in the `Init_` method to associate a Ruby method with a C function in a different C source file. RDoc would not find this function without your help: you add a reference to the file containing the function definition by adding a special comment to the `rb_define_method` call. The following example tells RDoc to look in the file `md5.c` for the function (and related comment) corresponding to the `md5` method.

```
rb_define_method(cCipher, "md5", gen_md5, -1); /* in md5.c */
```

Figure 16.6 on the next page shows a C source file documented using RDoc. Note that the bodies of several internal methods have been elided to save space.

Figure 16.6. C source file documented with RDoc

```

#include "ruby.h"
#include "cdjukebox.h"

static VALUE cCDPlayer;
static void cd_free(void *p) { ... }
static VALUE cd_alloc(VALUE klass) { ... }
static void progress(CDJukebox *rec, int percent) { ... }

/* call-seq:
 * CDPlayer.new(unit) -> new_cd_player
 *
 * Assign the newly created CDPlayer to a particular unit
 */
static VALUE cd_initialize(VALUE self, VALUE unit) {
 int unit_id;
 CDJukebox *jb;

 Data_Get_Struct(self, CDJukebox, jb);

 unit_id = NUM2INT(unit);
 assign_jukebox(jb, unit_id);

 return self;
}

/* call-seq:
 * player.seek(int_disc, int_track) -> nil
 * player.seek(int_disc, int_track) {|percent| } -> nil
 *
 * Seek to a given part of the track, invoking the block
 * with the percent complete as we go.
 */
static VALUE
cd_seek(VALUE self, VALUE disc, VALUE track) {
 CDJukebox *jb;
 Data_Get_Struct(self, CDJukebox, jb);

 jukebox_seek(jb, NUM2INT(disc), NUM2INT(track), progress);
 return Qnil;
}

/* call-seq:
 * player.seek_time -> Float
 *
 * Return the average seek time for this unit (in seconds)
 */
static VALUE
cd_seek_time(VALUE self)
{
 double tm;
 CDJukebox *jb;
 Data_Get_Struct(self, CDJukebox, jb);
 tm = get_avg_seek_time(jb);
 return rb_float_new(tm);
}

/* Interface to the Spinzalot[http://spinzalot.cd]
 * CD Player library.
 */

void Init_CDPlayer() {
 cCDPlayer = rb_define_class("CDPlayer", rb_cObject);
 rb_define_alloc_func(cCDPlayer, cd_alloc);
 rb_define_method(cCDPlayer, "initialize", cd_initialize, 1);
 rb_define_method(cCDPlayer, "seek", cd_seek, 2);
 rb_define_method(cCDPlayer, "seek_time", cd_seek_time, 0);
}

```

## Running RDoc

You run RDoc from the command line.

```
% rdoc [options] [filenames...]
```

Type **rdoc --help** for an up-to-date option summary.

Files are parsed, and the information they contain collected, before any output is produced. This allows cross-references between all files to be resolved. If a name is a directory, it is traversed. If no names are specified, all Ruby files in the current directory (and subdirectories) are processed.

A typical use may be to generate documentation for a package of Ruby source (such as RDoc itself).

```
% rdoc
```

This command generates HTML documentation for all the Ruby and C source files in and below the current directory. These will be stored in a documentation tree starting in the subdirectory `doc/`.

RDoc uses file extensions to determine how to process each file. Filenames ending `.rb` and `.rbw` are assumed to be Ruby source. Files ending `.c` are parsed as C files. All other files are assumed to contain just markup (with or without leading `#` comment markers). If directory names are passed to RDoc, they are scanned recursively for C and Ruby source files only. To include nonsource files such as READMEs in the documentation process, their names must be given explicitly on the command line.

When writing a Ruby library, you often have some source files that implement the public interface, but the majority are internal and of no interest to the readers of your documentation. In these cases, construct a `.document` file in each of your project's directories. If RDoc enters a directory containing a `.document` file, it will process only the files in that directory whose names match one of the lines in that file. Each line in the file can be a filename, a directory name, or a wildcard (a file system “glob” pattern). For example, to include all Ruby files whose names start `main`, along with the file `constants.rb`, you could use a `.document` file containing

```
main*.rb
constants.rb
```

Some project standards ask for documentation in a top-level README file. You may find it convenient to write this file in RDoc format, and then use the `:include:` directive to incorporate this document into that for the main class.

## Create Documentation for ri

RDoc is also used to create documentation which will be later displayed using ri.

When you run ri, it by default looks for documentation in three places:<sup>2</sup>

1. the *system* documentation directory, which holds the documentation distributed with Ruby, and which is created by the Ruby install process,
2. the *site* directory, which contains sitewide documentation added locally, and
3. the *user* documentation directory, stored under the user's own home directory.

You can find these three directories in the following locations.

- `$datadir/ri/<ver>/system/...`
- `$datadir/ri/<ver>/site/...`
- `~/.rdoc/...`

The variable `$datadir` is the configured data directory for the installed Ruby. Find your local *datadir* using

```
ruby -r rbconfig -e 'p Config::CONFIG["datadir"]'
```

To add documentation to ri, you need to tell RDoc which output directory to use. For your own use, it's easiest to use the `--ri` option.

```
% rdoc --ri file1.rb file2.rb
```

If you want to install sitewide documentation, use the `--ri-site` option.

```
% rdoc --ri-site file1.rb file2.rb
```

The `--ri-system` option is normally used only to install documentation for Ruby's built-in classes and standard libraries. You can regenerate this documentation from the Ruby source distribution (not from the installed libraries themselves).

```
% cd <ruby source base>/lib
% rdoc --ri-system
```

## Displaying Program Usage

Most command line programs have some kind of facility to describe their correct usage; give them invalid parameters and they'll report a short error message followed by a synopsis of their actual options. And, if you're using RDoc, you'll probably have described

---

2. You can override the directory location using the `--op` option to RDoc, and subsequently using the `--doc-dir` option with ri.

Figure 16.7. Sample program using RDoc::usage

```

== Synopsis
#
Display the current date and time, optionally honoring
a format string.
#
== Usage
#
ruby showtime.rb [-h | --help] [-f | --fmt fmtstring]
#
fmtstring::
A +strftime+ format string controlling the
display of the date and time. If omitted,
use "%Y-%M-%d %H:%m"
#
== Author
Dave Thomas, The Pragmatic Programmers, LLC
#
== Copyright
Copyright (c) 2004 The Pragmatic Programmers.
Licensed under the same terms as Ruby.

require 'optparse'
require 'rdoc/usage'

fmt = "%Y-%M-%d %H:%m"
opts = OptionParser.new
opts.on("-h", "--help") { RDoc::usage }
opts.on("-f", "--fmt FMTSTRING") {|str| fmt = str }
opts.parse(ARGV) rescue RDoc::usage('usage')

puts Time.now.strftime(fmt)

```

how the program should be used in a RDoc comment at the start of the main program. Rather than duplicate all this information in a puts somewhere, you can use `RDoc::usage` to extract it straight from the command and write it to the user.

You can pass `RDoc::usage` a number of string parameters. If present, it extracts from the comment block only those sections named by parameters (where a section starts with a heading equal to the parameter, ignoring case). With no string parameters, `RDoc::usage` displays the entire comment. In addition, `RDoc::usage` exits the program after displaying the usage message. If the first parameter in the call is an integer, it is used as the program's exit code (otherwise `RDoc::usage` exits with a zero error code). If you don't want to exit the program after displaying a usage message, call `RDoc::usage_no_exit`.

Figure 16.7 shows a trivial program that displays the time. It uses `RDoc::usage` to display the complete comment block if the user asks for help, and to display just the

```

~/Work/rubybook/code
% ruby showtime.rb --help
Synopsis
Display the current date and time, optionally honoring a format string.

Usage
 ruby showtime.rb [-h | --help] [-f | --fmt fmtstring]

fmtstring: A strftime format string controlling the display of the date
and time. If omitted, use "%Y-%M-%d %H:%m"

Author
Dave Thomas, The Pragmatic Programmers, LLC

Copyright
Copyright (c) 2004 The Pragmatic Programmers. Licensed under the same
terms as Ruby.

%

```

Figure 16.8. Help generated by sample program

usage section if the user gives an invalid option. Figure 16.8 shows the output generated in response to a `--help` option.

RDoc : :usage honors the RI environment variable, which can be used to set the display width and output style. The output in Figure 16.8 was generated with the RI option set to “-f ansi.” Although not too apparent if you’re looking at this figure in the black-and-white book, the section headings, code font, and emphasized font are shown in different colors using ANSI escape sequences.

*Chad Fowler is a leading figure in the Ruby community. He's on the board of Ruby Central, Inc. He's one of the organizers of RubyConf. And he's one of the writers of RubyGems. All this makes him uniquely qualified to write this chapter.*

## Chapter 17

# Package Management with RubyGems

---

RubyGems is a standardized packaging and installation framework for libraries and applications, making it easy to locate, install, upgrade, and uninstall Ruby packages. It provides users and developers with four main facilities.

1. A standardized package format,
2. A central repository for hosting packages in this format,
3. Installation and management of multiple, simultaneously installed versions of the same library,
4. End-user tools for querying, installing, uninstalling, and otherwise manipulating these packages.

Before RubyGems came along, installing a new library involved searching the Web, downloading a package, and attempting to install it—only to find that its dependencies haven't been met. If the library you want is packaged using RubyGems, however, you can now simply ask RubyGems to install it (and all its dependencies). Everything is done for you.

In the RubyGems world, developers bundle their applications and libraries into single files called *gems*. These files conform to a standardized format, and the RubyGems system provides a command-line tool, appropriately named *gem*, for manipulating these gem files.

In this chapter, we'll see how to

1. Install RubyGems on your computer.
2. Use RubyGems to install other applications and libraries.
3. Write your own gems.

## Installing RubyGems

To use RubyGems, you'll first need to download and install the RubyGems system from the project's home page at <http://rubygems.rubyforge.org>. After downloading and unpacking the distribution, you can install it using the included installation script.

```
% cd rubygems-0.7.0
% ruby install.rb
```

Depending on your operating system, you may need suitable privileges to write files into Ruby's `site_ruby/` and `bin/` directories.

The best way to test that RubyGems was installed successfully also happens to be the most important command you'll learn.

```
% gem help
RubyGems is a sophisticated package manager for Ruby. This is
a basic help message containing pointers to more information.

Usage:
 gem -h/--help
 gem -v/--version
 gem command [arguments...] [options...]

Examples:
 gem install rake
 gem list --local
 gem build package.gemspec
 gem help install

Further help:
 gem help commands list all 'gem' commands
 gem help examples show some examples of usage
 gem help <COMMAND> show help on COMMAND
 (e.g. 'gem help install')

Further information:
 http://rubygems.rubyforge.org
```

Because RubyGems' help is quite comprehensive, we won't go into detail about each of the available RubyGems commands and options in this chapter.

## Installing Application Gems

Let's start by using RubyGems to install an application that is written in Ruby. Jim Weirich's Rake (<http://rake.rubyforge.org>) holds the distinction of being the first application that was available as a gem. Not only that, but it's generally a great tool to have around, as it is a build tool similar to Make and Ant. In fact, you can even use Rake to build gems!

Locating and installing Rake with RubyGems is simple.



```
% gem install -r rake
Attempting remote installation of 'rake'
Successfully installed rake, version 0.4.3
% rake --version
rake, version 0.4.3
```

RubyGems downloads the Rake package and installs it. Because Rake is an application, RubyGems downloads both the Rake libraries and the command-line program rake.

You control the gem program using subcommands, each of which has its own options and help screen. In this example, we used the `install` subcommand with the `-r` option, which tells it to operate remotely. (Many RubyGems operations can be performed either locally or remotely. For example, you can use the `query` command either to display all the gems that are available remotely for installation or to display a list of gems you already have installed. For this reason, subcommands accept the options `-r` and `-l`, specifying whether an operation is meant to be carried out remotely or locally.)

If for some reason—perhaps because of a potential compatibility issue—you wanted an older version of Rake, you could use RubyGems’ version requirement operators to specify criteria by which a version would be selected.

```
% gem install -r rake -v "< 0.4.3"
Attempting remote installation of 'rake'
Successfully installed rake, version 0.4.2
% rake --version
rake, version 0.4.2
```

Table 17.1 on the following page lists the version requirement operators. The `-v` argument in our previous example asks for the highest version lower than 0.4.3.

There’s a subtlety when it comes to installing different versions of the same application with RubyGems. Even though RubyGems keeps separate versions of the application’s library files, it does not version the actual command you use to run the application. As a result, each install of an application effectively overwrites the previous one.

During installation, you can also add the `-t` option to the RubyGems `install` command, causing RubyGems to run the gem’s test suite (if one has been created). If the tests fail, the installer will prompt you to either keep or discard the gem. This is a good way to gain a little more confidence that the gem you’ve just downloaded works on your system the way the author intended.

```
% gem install SomePoorlyTestedProgram -t
Attempting local installation of 'SomePoorlyTestedProgram-1.0.1'
Successfully installed SomePoorlyTestedProgram, version 1.0.1
23 tests, 22 assertions, 0 failures, 1 errors...keep Gem? [Y/n] n
Successfully uninstalled SomePoorlyTestedProgram version 1.0.1
```

Had we chosen the default and kept the gem installed, we could have inspected the gem to try to determine the cause of the failing test.

Table 17.1. Version operators

Both the `require_gem` method and the `add_dependency` attribute in a `Gem::Specification` accept an argument that specifies a version dependency. RubyGems version dependencies are of the form `operator major.minor.patch_level`. Listed below is a table of all the possible version operators.

| Operator | Description                                                                                                                                                                                                                                                        |
|----------|--------------------------------------------------------------------------------------------------------------------------------------------------------------------------------------------------------------------------------------------------------------------|
| =        | Exact version match. Major, minor, and patch level must be identical.                                                                                                                                                                                              |
| !=       | Any version that is not the one specified.                                                                                                                                                                                                                         |
| >        | Any version that is greater (even at the patch level) than the one specified.                                                                                                                                                                                      |
| <        | Any version that is less than the one specified.                                                                                                                                                                                                                   |
| >=       | Any version greater than or equal to the specified version.                                                                                                                                                                                                        |
| <=       | Any version less than or equal to the specified version.                                                                                                                                                                                                           |
| ~>       | “Boxed” version operator. Version must be greater than or equal to the specified version <i>and</i> less than the specified version after having its minor version number increased by one. This is to avoid API incompatibilities between minor version releases. |

## Installing and Using Gem Libraries

Using RubyGems to install a complete application was a good way to get your feet wet and to start to learn your way around the `gem` command. However, in most cases, you’ll use RubyGems to install Ruby libraries for use in your own programs. Since RubyGems enables you to install and manage multiple versions of the same library, you’ll also need to do some new, RubyGems-specific things when you require those libraries in your code.

Perhaps you’ve been asked by your mother to create a program to help her maintain and publish a diary. You have decided that you would like to publish the diary in HTML format, but you are worried that your mother may not understand all of the ins and outs of HTML markup. For this reason, you’ve opted to use one of the many excellent templating packages available for Ruby. After some research, you’ve decided on Michael Granger’s `BlueCloth`, based on its reputation for being very simple to use.

You first need to find and install the `BlueCloth` gem.

```
% gem query -rn Blue
*** REMOTE GEMS ***
BlueCloth (0.0.4, 0.0.3, 0.0.2)
 BlueCloth is a Ruby implementation of Markdown, a text-to-HTML
 conversion tool for web writers. Markdown allows you to write using
 an easy-to-read, easy-to-write plain text format, then convert it
 to structurally valid XHTML (or HTML).
```

This invocation of the query command uses the `-n` option to search the central gem repository for any gem whose name matches the regular expression `/Blue/`. The results show that three available versions of BlueCloth exist (0.0.4, 0.0.3, and 0.0.2). Because you want to install the most recent one, you don't have to state an explicit version on the `install` command; the latest is downloaded by default.

```
% gem install -r BlueCloth
Attempting remote installation of 'BlueCloth'
Successfully installed BlueCloth, version 0.0.4
```

## Generating API Documentation

Being that this is your first time using BlueCloth, you're not exactly sure how to use it. You need some API documentation to get started. Fortunately, with the addition of the `--rdoc` option to the `install` command, RubyGems will generate RDoc documentation for the gem it is installing. For more information on RDoc, see Chapter 16 on page 187.

```
% gem install -r BlueCloth --rdoc
Attempting remote installation of 'BlueCloth'
Successfully installed BlueCloth, version 0.0.4
Installing RDoc documentation for BlueCloth-0.0.4...
WARNING: Generating RDoc on .gem that may not have RDoc.
 bluecloth.rb: cc.....
Generating HTML...
```

Having generated all this useful HTML documentation, how can you view it? You have at least two options. The hard way (though it really isn't that hard) is to open RubyGems' documentation directory and browse the documentation directly. As with most things in RubyGems, the documentation for each gem is stored in a central, protected, RubyGems-specific place. This will vary by system and by where you may explicitly choose to install your gems. The most reliable way to find the documents is to ask the `gem` command where your RubyGems main directory is located. For example:

```
% gem environment gemdir
/usr/local/lib/ruby/gems/1.8
```

RubyGems stores generated documentation in the `doc/` subdirectory of this directory, in this case `/usr/local/lib/ruby/gems/1.8/doc`. You can open the file `index.html` and view the documentation. If you find yourself using this path often, you can create a shortcut. Here's one way to do that on Mac OS X boxes.

```
% gemdoc=`gem environment gemdir`/doc
% ls $gemdoc
BlueCloth-0.0.4
% open $gemdoc/BlueCloth-0.0.4/rdoc/index.html
```

To save time, you could declare `$gemdoc` in your login shell's profile or rc file.

The second (and easier) way to view gems' RDoc documentation is to use RubyGems' included `gem_server` utility. To start `gem_server`, simply type

```
% gem_server
[2004-07-18 11:28:51] INFO WEBrick 1.3.1
[2004-07-18 11:28:51] INFO ruby 1.8.2 (2004-06-29) [i386-mswin32]
[2004-07-18 11:28:51] INFO WEBrick::HTTPServer#start: port=8808
```

`gem_server` starts a Web server running on whatever computer you run it on. By default, it will start on port 8808 and will serve gems and their documentation from the default RubyGems installation directory. Both the port and the gem directory are overridable via command-line options, using the `-p` and `-d` options, respectively.

Once you've started the `gem_server` program, if you are running it on your local computer, you can access the documentation for your installed gems by pointing your Web browser to <http://localhost:8808>. There, you will see a list of the gems you have installed with their descriptions and links to their RDoc documentation.

## Let's Code!

Now you've got BlueCloth installed and you know how to use it, you're ready to write some code. Having used RubyGems to download the library, we can now also use it to load the library components into our application. Prior to RubyGems, we'd say something like

```
require 'bluecloth'
```

With RubyGems, though, we can take advantage of its packaging and versioning support. To do this, we use `require_gem` in place of `require`.

```
require 'rubygems'
require_gem 'BlueCloth', ">= 0.0.4"
doc = BlueCloth::new <<MARKUP
 This is some sample [text][1]. Just learning to use [BlueCloth][1].
 Just a simple test.
 [1]: http://ruby-lang.org
MARKUP
puts doc.to_html
```

*produces:*

```
<p>This is some sample text. Just
learning to use BlueCloth.
Just a simple test.</p>
```

The first two lines are the RubyGems-specific code. The first line loads the RubyGems core libraries that we'll need in order to work with installed gems.

```
require 'rubygems'
```

The second line is where most of the magic happens.

```
require_gem 'BlueCloth', '>= 0.0.4'
```

This line adds the BlueCloth gem to Ruby's \$LOAD\_PATH and uses `require` to load any libraries that the gem's creator specified to be autoloaded. Let's say that again a slightly different way.

Each gem is considered to be a bundle of resources. It may contain one library file or one hundred. In an old-fashioned, non-RubyGems library, all these files would be copied into some shared location in the Ruby library tree, a location that was in Ruby's predefined load path.

RubyGems doesn't work this way. Instead, it keeps each version of each gem in its own self-contained directory tree. The gems are not injected into the standard Ruby library directories. As a result, RubyGems needs to do some fancy footwork so that you can get to these files. It does this by adding the gem's directory tree to Ruby's load path. From inside a running program, the effect is the same: `require` just works. From the outside, though, RubyGems gives you far better control over what's loaded into your Ruby programs.

In the case of BlueCloth, the templating code is distributed as one file, `bluecloth.rb`; that's the file that `require_gem` will load. `require_gem` has an optional second argument, which specifies a version requirement. In this example, you've specified that BlueCloth version 0.0.4 or greater be installed to use this code. If you had required version 0.0.5 or greater, this program would fail, because the version you've just installed is too low to meet the requirement of the program.

```
require 'rubygems'
require_gem 'BlueCloth', '>= 0.0.5'
```

*(produces no output)*

As we said earlier, the version requirement argument is optional, and this example is obviously contrived. But, it's easy to imagine how this feature can be useful as different projects begin to depend on multiple, potentially incompatible, versions of the same library.

## Dependent on RubyGems?

Astute readers (that's all of you) will have noticed that the code we've created so far is dependent on the RubyGems package being installed. In the long term, that'll be a fairly safe bet (we're guessing that RubyGems will make its way into the Ruby core distribution). For now, though, RubyGems is not part of the standard Ruby distribution, so users of your software may not have RubyGems installed on their computers. If we distribute code that has `require 'rubygems'` in it, that code will fail.

### The Code Behind the Curtain

So just what does happen behind the scenes when you call the magic `require_gem` method?

First, the gems library modifies your `$LOAD_PATH`, including any directories you have added to the gemspec's `require_paths`. Second, it calls Ruby's `require` method on any files specified in the gemspec's `autorequires` attribute (described on page 212). It's this `$LOAD_PATH`-modifying behavior that enables RubyGems to manage multiple installed versions of the same library.

You can use at least two techniques to get around this issue. First, you can wrap the RubyGems-specific code in a block and use Ruby's exception handling to rescue the resultant `LoadError` should RubyGems not be found during the `require`.

```
begin
 require 'rubygems'
 require_gem 'BlueCloth', ">= 0.0.4"
rescue LoadError
 require 'bluecloth'
end
```

This code first tries to require in the RubyGems library. If this fails, the `rescue` stanza is invoked, and your program will try to load `BlueCloth` using a conventional `require`. This latter `require` will fail if `BlueCloth` isn't installed, which is the same behavior users see now if they're not using RubyGems.

Alternatively, RubyGems can generate and install a stub file during gem installation. This stub file is inserted into the standard Ruby library location and will be named after the gem package contents (so the stub for `BlueCloth` will be called `bluecloth.rb`). People using this library can then simply say

```
require 'bluecloth'
```

This is exactly what they would have said in pre-RubyGems days. The difference now is that rather than loading `BlueCloth` directly, they'll instead load the stub, which will in turn call `require_gem` to load the correct package. A stub file for `BlueCloth` would look something like this.

```
require 'rubygems'
$.delete('bluecloth.rb')
require_gem 'BlueCloth'
```

The stub keeps all the RubyGems-specific code in one place, so dependent libraries won't need to include any RubyGems code in their source. The `require_gem` call will load whatever library files the gem maintainer has specified as being autoloaded.

As of RubyGems 0.7.0, stub installation is enabled by default. During installation, you can disable it with the `--no-install-stub` option. The biggest disadvantage of using the library stubs is that you lose RubyGems' ability to manage multiple installed versions of the same library. If you need a specific version of a library, it's better to use the `LoadError` method described previously.

## Creating Your Own Gems

By now, you've seen how easy RubyGems makes things for the users of an application or library and are probably ready to make a gem of your own. If you're creating code to be shared with the open-source community, RubyGems are an ideal way for end-users to discover, install, and uninstall your code. They also provide a powerful way to manage internal, company projects, or even personal projects, since they make upgrades and rollbacks so simple. Ultimately, the availability of more gems makes the Ruby community stronger. These gems have to come from somewhere; we're going to show you how they can start coming from you.

Let's say you've finally gotten your mother's online diary application, MomLog, finished, and you have decided to release it under an open-source license. After all, other programmers have mothers, too. Naturally, you want to release MomLog as a gem (moms love it when you give them gems).

### Package Layout

The first task in creating a gem is organizing your code into a directory structure that makes sense. The same rules that you would use in creating a typical tar or zip archive apply in package organization. Some general conventions follow.

- Put all of your Ruby source files under a subdirectory called `lib/`. Later, we'll show you how to ensure that this directory will be added to Ruby's `$LOAD_PATH` when users load this gem.
- If it's appropriate for your project, include a file under `lib/yourproject.rb` that performs the necessary `require` commands to load the bulk of the project's functionality. Before RubyGems' `autorequire` feature, this made things easier for others to use a library. Even with RubyGems, it makes it easier for others to explore your code if you give them an obvious starting point.
- Always include a `README` file including a project summary, author contact information, and pointers for getting started. Use `RDoc` format for this file so you

can add it to the documentation that will be generated during gem installation. Remember to include a copyright and license in the README file, as many commercial users won't use a package unless the license terms are clear.

- Tests should go in a directory called `test/`. Many developers use a library's unit tests as a usage guide. It's nice to put them somewhere predictable, making them easy for others to find.
- Any executable scripts should go in a subdirectory called `bin/`.
- Source code for Ruby extensions should go in `ext/`.
- If you've got a great deal of documentation to include with your gem, it's good to keep it in its own subdirectory called `docs/`. If your README file is in the top level of your package, be sure to refer readers to this location.

This directory layout is illustrated in Figure 17.1 on page 220.

## The Gem Specification

Now that you've got your files laid out as you want them, it's time to get to the heart of gem creation: the gem specification, or *gemspec*. A *gemspec* is a collection of metadata in Ruby or YAML (see page 737) that provides key information about your gem. The *gemspec* is used as input to the gem-building process. You can use several different mechanisms to create a gem, but they're all conceptually the same. Here's your first, basic MomLog gem.

```
require 'rubygems'
SPEC = Gem::Specification.new do |s|
 s.name = "MomLog"
 s.version = "1.0.0"
 s.author = "Jo Programmer"
 s.email = "jo@joshost.com"
 s.homepage = "http://www.joshost.com/MomLog"
 s.platform = Gem::Platform::RUBY
 s.summary = "An online Diary for families"
 s.candidates = Dir.glob("{bin,docs,lib,tests}/**/*")
 s.files = candidates.delete_if do |item|
 item.include?("CVS") || item.include?("rdoc")
 end
 s.require_path = "lib"
 s.autorequire = "momlog"
 s.test_file = "tests/ts_momlog.rb"
 s.has_rdoc = true
 s.extra_rdoc_files = ["README"]
 s.add_dependency("BlueCloth", ">= 0.0.4")
end
```



Let's quickly walk through this example. A gem's metadata is held in an object of class `Gem::Specification`. The `gemspec` can be expressed in either YAML or Ruby code. Here we'll show the Ruby version, as it's generally easier to construct and more flexible in use. The first five attributes in the specification give basic information such as the gem's name, the version, and the author's name, e-mail, and home page.

In this example, the next attribute is the platform on which this gem can run. In this case, the gem is a pure Ruby library with no operating system-specific requirements, so we've set the platform to RUBY. If this gem were written for Windows only, for example, the platform would be listed as WIN32. For now, this field is only informational, but in the future it will be used by the gem system for intelligent selection of precompiled native extension gems.

The gem's summary is the short description that will appear when you run a `gem query` (as in our previous BlueCloth example).

The `files` attribute is an array of pathnames to files that will be included when the gem is built. In this example, we've used `Dir.glob` to generate the list and filtered out CVS and RDoc files.

## Runtime Magic

The next two attributes, `require_path` and `autorequire`, let you specify the directories that will be added to the `$LOAD_PATH` when `require_gem` loads the gem, as well as any files that will automatically be loaded using `require`. In this example, `lib` refers to a relative path under the MomLog gem directory, and the `autorequire` will cause `lib/momlog.rb` to be required when `require_gem "MomLog"` is called. For each of these two attributes, RubyGems provides corresponding plural versions, `require_paths` and `autorequires`. These take arrays, allowing you to have many files automatically loaded from different directories when the gem is loaded using `require_gem`.

## Adding Tests and Documentation

The `test_file` attribute holds the relative pathname to a single Ruby file included in the gem that should be loaded as a `Test::Unit` test suite. (You can use the plural form, `test_files`, to reference an array of files containing tests.) For details on how to create a test suite, see Chapter 12 on page 143 on unit testing.

Finishing up this example, we have two attributes controlling the production of local documentation of the gem. The `has_rdoc` attribute specifies that you have added RDoc comments to your code. It's possible to run RDoc on totally uncommented code, providing a browsable view of its interfaces, but obviously this is a lot less valuable than running RDoc on well-commented code. `has_rdoc` is a way for you to tell the world, "Yes. It's worth generating the documentation for this gem."

RDoc has the convenience of being very readable in both source and rendered form, making it an excellent choice for an included README file with a package. By default, however, the `rdoc` command will run only on source code files. The `extra_rdoc_file` attribute takes an array of paths to non-source files in your gem that you would like to be included in the generation of RDoc documentation.

## Adding Dependencies

For your gem to work properly, users are going to need to have BlueCloth installed.

We saw earlier how to set a load-time version dependency for a library. Now we need to tell our `gemspec` about that dependency, so the installer will ensure that it is present while installing MomLog. We do that with the addition of a single method call to our `Gem::Specification` object.

```
s.add_dependency("BlueCloth", ">= 0.0.4")
```

The arguments to our `add_dependency` method are identical to those of `require_gem`, which we explained earlier.

After generating this gem, attempting to install it on a clean system would look something like this.

```
% gem install pkg/MomLog-1.0.0.gem
Attempting local installation of 'pkg/MomLog-1.0.0.gem'
/usr/local/lib/ruby/site_ruby/1.8/rubygems.rb:50:in `require_gem':
 (LoadError)
Could not find RubyGem BlueCloth (>= 0.0.4)
```

Because you are performing a local installation from a file, RubyGems won't attempt to resolve the dependency for you. Instead, it fails noisily, telling you that it needs BlueCloth to complete the installation. You could then install BlueCloth as we did before, and things would go smoothly the next time you attempted to install the MomLog gem.

If you had uploaded MomLog to the central RubyGems repository and then tried to install it on a clean system, you would be prompted to automatically install BlueCloth as part of the MomLog installation.

```
% gem install -r MomLog
Attempting remote installation of 'MomLog'
Install required dependency BlueCloth? [Yn] y
Successfully installed MomLog, version 1.0.0
```

Now you've got both BlueCloth and MomLog installed, and your mother can start happily publishing her diary. Had you chosen not to install BlueCloth, the installation would have failed as it did during the local installation attempt.

As you add more features to MomLog, you may find yourself pulling in additional external gems to support those features. The `add_dependency` method can be called multiple times in a single `gemspec`, supporting as many dependencies as you need it to support.

## Ruby Extension Gems

So far, all of the examples we've looked at have been pure Ruby code. However, many Ruby libraries are created as native extensions (see Chapter 21 on page 261). You have two ways to package and distribute this kind of library as a gem. You can distribute the gem in source format and have the installer compile the code at installation time. Alternatively, you can precompile the extensions and distribute one gem for each separate platform you want to support.

For source gems, RubyGems provides an additional `Gem::Specification` attribute called `extensions`. This attribute is an array of paths to Ruby files that will generate Makefiles. The most typical way to create one of these programs is to use Ruby's `mkmf` library (see Chapter 21 on page 261 and the appendix about `mkmf` on page 755). These files are conventionally named `extconf.rb`, though any name will do.

Your mom has a computerized recipe database that is near and dear to her heart. She has been storing her recipes in it for years, and you would like to give her the ability to publish these recipes on the Web for her friends and family. You discover that the recipe program, `MenuBuilder`, has a fairly nice native API and decide to write a Ruby extension to wrap it. Since the extension may be useful to others who aren't necessarily using `MomLog`, you decide to package it as a separate gem and add it as an additional dependency for `MomLog`.

Here's the `gemspec`.

```
require 'rubygems'
spec = Gem::Specification.new do |s|
 s.name = "MenuBuilder"
 s.version = "1.0.0"
 s.author = "Jo Programmer"
 s.email = "jo@joshost.com"
 s.homepage = "http://www.joshost.com/projects/MenuBuilder"
 s.platform = Gem::Platform::RUBY
 s.summary = "A Ruby wrapper for the MenuBuilder recipe database."
 s.files = ["ext/main.c", "ext/extconf.rb"]
 s.require_path = "."
 s.autorequire = "MenuBuilder"
 s.extensions = ["ext/extconf.rb"]
end
if $0 == __FILE__
 Gem::manage_gems
 Gem::Builder.new(spec).build
end
```

Note that you have to include source files in the specification's `files` list so they'll be included in the gem package for distribution.

When a source gem is installed, RubyGems runs each of its `extensions` programs and then executes the resultant Makefile.

```
% gem install MenuBuilder-1.0.0.gem
Attempting local installation of 'MenuBuilder-1.0.0.gem'
ruby extconf.rb inst MenuBuilder-1.0.0.gem
creating Makefile
make
gcc -fPIC -g -O2 -I. -I/usr/local/lib/ruby/1.8/i686-linux \
-I/usr/local/lib/ruby/1.8/i686-linux -I. -c main.c
gcc -shared -L"/usr/local/lib" -o MenuBuilder.so main.o \
-ldl -lcrypt -lm -lc
make install
install -c -p -m 0755 MenuBuilder.so \
/usr/local/lib/ruby/gems/1.8/gems/MenuBuilder-1.0.0/.
Successfully installed MenuBuilder, version 1.0.0
```

RubyGems does not have the capability to detect system library dependencies that source gems may have. Should your source gems depend on a system library that is not installed, the gem installation will fail, and any error output from the make command will be displayed.

Distributing source gems obviously requires that the consumer of the gem have a working set of development tools. At a minimum, they'll need some kind of make program and a compiler. Particularly for Windows users, these tools may not be present. You can get around this limitation by distributing precompiled gems.

Creation of precompiled gems is simple—add the compiled shared object files (DLLs on Windows) to the gemspec's files list, and make sure these files are in one of the gem's `require_path` attributes. As with pure Ruby gems, the `require_gem` command will modify Ruby's `$LOAD_PATH`, and the shared object will be accessible via `require`.

Since these gems will be platform specific, you can also use the `platform` attribute (remember this from the first gemspec example?) to specify the target platform for the gem. The `Gem::Specification` class defines constants for Windows, Intel Linux, Macintosh, and pure Ruby. For platforms not included in this list, you can use the value of the `RUBY_PLATFORM` variable. This attribute is purely informational for now, but it's a good habit to acquire. Future RubyGems releases will use the `platform` attribute to intelligently select precompiled gems for the platform on which the installer is running.

## Building the Gem File

The MomLog gemspec we just created is runnable as a Ruby program. Invoking it will create a gem file, `MomLog-0.5.0.gem`.

```
% ruby momlog.gemspec
Attempting to build gem spec 'momlog.gemspec'
Successfully built RubyGem
Name: MomLog
Version: 0.5.0
File: MomLog-0.5.0.gem
```

Alternatively, you can use the `gem build` command to generate the gem file.

```
% gem build momlog.gemspec
Attempting to build gem spec 'momlog.gemspec'
Successfully built RubyGem
Name: MomLog
Version: 0.5.0
File: MomLog-0.5.0.gem
```

Now that you've got a gem file, you can distribute it like any other package. You can put it on an FTP server or a Web site for download or e-mail it to your friends. Once your friends have got this file on their local computers (downloading from your FTP server if necessary), they can install the gem (assuming they have RubyGems installed too) by calling

```
% gem install MomLog-0.5.0.gem
Attempting local installation of 'MomLog-0.5.0.gem'
Successfully installed MomLog, version 0.5.0
```

If you would like to release your gem to the Ruby community, the easiest way is to use RubyForge (<http://rubyforge.org>). RubyForge is an open-source project management Web site. It also hosts the central gem repository. Any gem files released using RubyForge's file release feature will be automatically picked up and added to the central gem repository several times each day. The advantage to potential users of your software is that it will be available via RubyGems' remote query and installation operations, making installation even easier.

## Building with Rake

Last but certainly not least, we can use Rake to build gems (remember Rake, the pure-Ruby build tool we mentioned back on page 204). Rake uses a command file called a `Rakefile` to control the build. This defines (in Ruby syntax!) a set of *rules* and *tasks*. The intersection of make's rule-driven concepts and Ruby's power make for a build and release automator's dream environment. And, what release of a Ruby project would be complete without the generation of a gem?

For details on how to use Rake, see <http://rake.rubyforge.org>. Its documents are comprehensive and always up-to-date. Here, we'll focus on just enough Rake to build a gem. From the Rake documentation:

*Tasks are the main unit of work in a Rakefile. Tasks have a name (usually given as a symbol or a string), a list of prerequisites (more symbols or strings), and a list of actions (given as a block).*

Normally, you can use Rake's built-in `task` method to define your own named tasks in your `Rakefile`. For special cases, it makes sense to provide helper code to automate some of the repetitive work you would have to do otherwise. Gem creation is one of

these special cases. Rake comes with a special *TaskLib*, called `GemPackageTask`, that helps integrate gem creation into the rest of your automated build and release process.

To use `GemPackageTask` in your Rakefile, create the `gemspec` exactly as we did previously, but this time place it into your Rakefile. We then feed this specification to `GemPackageTask`.

```
require 'rubygems'
Gem::manage_gems
require 'rake/gempackagetask'

spec = Gem::Specification.new do |s|
 s.name = "MomLog"
 s.version = "0.5.0"
 s.author = "Jo Programmer"
 s.email = "jo@joshost.com"
 s.homepage = "http://www.joshost.com/MomLog"
 s.platform = Gem::Platform::RUBY
 s.summary = "An online Diary for families"
 s.files = FileList["{bin,tests,lib,docs}/**/*"].exclude("rdoc").to_a
 s.require_path = "lib"
 s.autorequire = "momlog"
 s.test_file = "tests/ts_momlog.rb"
 s.has_rdoc = true
 s.extra_rdoc_files = ["README"]
 s.add_dependency("BlueCloth", ">= 0.0.4")
 s.add_dependency("MenuBuilder", ">= 1.0.0")
end

Rake::GemPackageTask.new(spec) do |pkg|
 pkg.need_tar = true
end
```

Note that you'll have to require the `rubygems` package into your Rakefile. You'll also notice that we've used Rake's `FileList` class instead of `Dir.glob` to build the list of files. `FileList` is smarter than `Dir.glob` for this purpose in that it automatically ignores commonly unused files (such as the CVS directory that the CVS version control tool leaves lying around).

Internally, the `GemPackageTask` generates a Rake target with the identifier

```
package_directory/gemname-gemversion.gem
```

In our case, this identifier will be `pkg/MomLog-0.5.0.gem`. You can invoke this task from the same directory where you've put the Rakefile.

```
% rake pkg/MomLog-0.5.0.gem
(in /home/chad/download/gembook/code/MomLog)
Successfully built RubyGem
Name: MomLog
Version: 0.5.0
File: MomLog-0.5.0.gem
```

Now that you've got a task, you can use it like any other Rake task, adding dependencies to it or adding it to the dependency list of another task, such as deployment or release packaging.

## Maintaining Your Gem (and One Last Look at MomLog)

You've released MomLog, and it's attracting new, adoring users every week. You have taken great care to package it cleanly and are using Rake to build your gem.

Your gem being "in the wild" with your contact information attached to it, you know that it's only a matter of time before you start receiving feature requests (and fan mail!) from your users. But, your first request comes via a phone call from none other than dear old Mom. She has just gotten back from a vacation in Florida and asks you how she can include her vacation pictures in her diary. You don't think an explanation of command-line FTP would be time well spent, and being the ever-devoted son or daughter, you spend your evening coding a nice photo album module for MomLog.

Since you have added functionality to the application (as opposed to just fixing a bug), you decide to increase MomLog's version number from 1.0.0 to 1.1.0. You also add a set of tests for the new functionality and a document about how to set up the photo upload functionality.

Figure 17.1 on the next page shows the complete directory structure of your final MomLog 1.1.0 package. The final gem specification (extracted from the Rakefile) looks like this.

```
spec = Gem::Specification.new do |s|
 s.name = "MomLog"
 s.version = "1.1.0"
 s.author = "Jo Programmer"
 s.email = "jo@joshost.com"
 s.homepage = "http://www.joshost.com/MomLog"
 s.platform = Gem::Platform::RUBY
 s.summary = "An online diary, recipe publisher, " +
 "and photo album for families."
 s.files = FileList["{bin,tests,lib,docs}/**/*"].exclude("rdoc").to_a
 s.require_path = "lib"
 s.autorequire = "momlog"
 s.test_file = "tests/ts_momlog.rb"
 s.has_rdoc = true
 s.extra_rdoc_files = ["README", "docs/DatabaseConfiguration.rdoc",
 "docs/Installing.rdoc", "docs/PhotoAlbumSetup.rdoc"]
 s.add_dependency("BlueCloth", ">= 0.0.4")
 s.add_dependency("MenuBuilder", ">= 1.0.0")
end
```

Figure 17.1. MomLog package structure

```

momlog/
├── README
├── Rakefile
├── bin/
│ └── momlog_server
├── docs/
│ ├── Installing.rdoc
│ ├── DatabaseConfiguration.rdoc
│ └── PhotoAlbumSetup.rdoc
├── lib/
│ ├── momlog.rb
│ └── momlog/
│ ├── diary.rb
│ ├── recipes.rb
│ ├── db.rb
│ ├── upload.rb
│ ├── photo_album.rb
│ └── rss.rb
└── tests/
 ├── ts_momlog.rb
 ├── tc_recipe.rb
 ├── tc_photo_album.rb
 ├── tc_upload.rb
 ├── tc_diary.rb
 └── tc_rss.rb

```

You run Rake over your Rakefile, generating the updated MomLog gem, and you're ready to release the new version. You log into your RubyForge account, and upload your gem to the "Files" section of your project. While you wait for RubyGems' automated process to release the gem into the central gem repository, you type a release announcement to post to your RubyForge project.

Within about an hour, you log in to your mother's Web server to install the new software for her. RubyGems makes things easy, but we have to take special care of Mom.

```
% gem query -rn MomLog
```

```
*** REMOTE GEMS ***
```

```
MomLog (1.1.0, 1.0.0)
```

```
 An online diary, recipe publisher, and photo album for families.
```



Great! The query indicates that there are two versions of MomLog available now. You type the `install` command without specifying a version argument, because you know that the default is to install the most recent version.

```
% gem install -r MomLog
Attempting remote installation of 'MomLog'
Successfully installed MomLog, version 1.1.0
```

You haven't changed any of the dependencies for MomLog, so your existing BlueCloth and MenuBuilder installations meet the requirements for MomLog 1.1.0.

Now that Mom's happy, it's time to go try some of her recently posted recipes.

# Ruby and the Web

---

Ruby is no stranger to the Internet. Not only can you write your own SMTP server, FTP daemon, or Web server in Ruby, but you can also use Ruby for more usual tasks such as CGI programming or as a replacement for PHP.

Many options are available for using Ruby to implement Web applications, and a single chapter can't do them all justice. Instead, we'll try to touch some of the highlights and point you toward libraries and resources that can help.

Let's start with some simple stuff: running Ruby programs as Common Gateway Interface (CGI) programs.

## Writing CGI Scripts

You can use Ruby to write CGI scripts quite easily. To have a Ruby script generate HTML output, all you need is something like

```
#!/usr/bin/ruby
print "Content-type: text/html\r\n\r\n"
print "<html><body>Hello World! It's #{Time.now}</body></html>\r\n"
```

Put this script in a CGI directory, mark it as executable, and you'll be able to access it via your browser. (If your Web server doesn't automatically add headers, you'll need to add the response header yourself.)

```
#!/usr/bin/ruby
print "HTTP/1.0 200 OK\r\n"
print "Content-type: text/html\r\n\r\n"
print "<html><body>Hello World! It's #{Time.now}</body></html>\r\n"
```

However, that's hacking around at a pretty low level. You'd need to write your own request parsing, session management, cookie manipulation, output escaping, and so on. Fortunately, options are available to make this easier.

## Using cgi.rb

Class CGI provides support for writing CGI scripts. With it, you can manipulate forms, cookies, and the environment; maintain stateful sessions; and so on. It's a fairly large class, but we'll take a quick look at its capabilities here.

## Quoting

When dealing with URLs and HTML code, you must be careful to quote certain characters. For instance, a slash character (/) has special meaning in a URL, so it must be “escaped” if it's not part of the pathname. That is, any / in the query portion of the URL will be translated to the string %2F and must be translated back to a / for you to use it. Space and ampersand are also special characters. To handle this, CGI provides the routines CGI.escape and CGI.unescape.

```
require 'cgi'
puts CGI.escape("Nicholas Payton/Trumpet & Flugel Horn")
```

*produces:*

```
Nicholas+Payton%2FTrumpet+%26+Flugel+Horn
```

More frequently, you may want to escape HTML special characters.

```
require 'cgi'
puts CGI.escapeHTML("a < 100 && b > 200")
```

*produces:*

```
a < 100 && b > 200
```

To get really fancy, you can decide to escape only certain HTML elements within a string.

```
require 'cgi'
puts CGI.escapeElement('<hr>Click Here
', 'A')
```

*produces:*

```
<hr>Click Here

```

Here only the A element is escaped; other elements are left alone. Each of these methods has an “un-” version to restore the original string.

```
require 'cgi'
puts CGI.unescapeHTML("a < 100 && b > 200")
```

*produces:*

```
a < 100 && b > 200
```

## Query Parameters

HTTP requests from the browser to your application may contain parameters, either passed as part of the URL or passed as data embedded in the body of the request.

Processing of these parameters is complicated by the fact that a value with a given name may be returned multiple times in the same request. For example, say we're writing a survey to find out why folks like Ruby. The HTML for our form looks like this.

```
<html>
<head><title>Test Form</title></head>
<body>
 I like Ruby because:
 <form target="cgi-bin/survey.rb">
 <input type="checkbox" name="reason" value="flexible" />
 It's flexible

 <input type="checkbox" name="reason" value="transparent" />
 It's transparent

 <input type="checkbox" name="reason" value="perlish" />
 It's like Perl

 <input type="checkbox" name="reason" value="fun" />
 It's fun
 <p>
 Your name: <input type="text" name="name">
 </p>
 <input type="submit"/>
</form>
</body>
</html>
```

When someone fills in this form, they might check multiple reasons for liking Ruby (as shown in Figure 18.1 on the following page). In this case, the form data corresponding to the name `reason` will have three values, corresponding to the three checked boxes.

Class `CGI` gives you access to form data in a couple of ways. First, we can just treat the `CGI` object as a hash, indexing it with field names and getting back field values.

```
require 'cgi'
cgi = CGI.new
cgi['name'] → "Dave Thomas"
cgi['reason'] → "flexible"
```

1.8

However, this doesn't work well with the `reason` field: we see only one of the three values. We can ask to see them all by using the `CGI#params` method. The value returned by `params` acts like a hash containing the request parameters. You can both read and write this hash (the latter allows you to modify the data associated with a request). Note that each of the values in the hash is actually an array.

Figure 18.1. Sample CGI Form

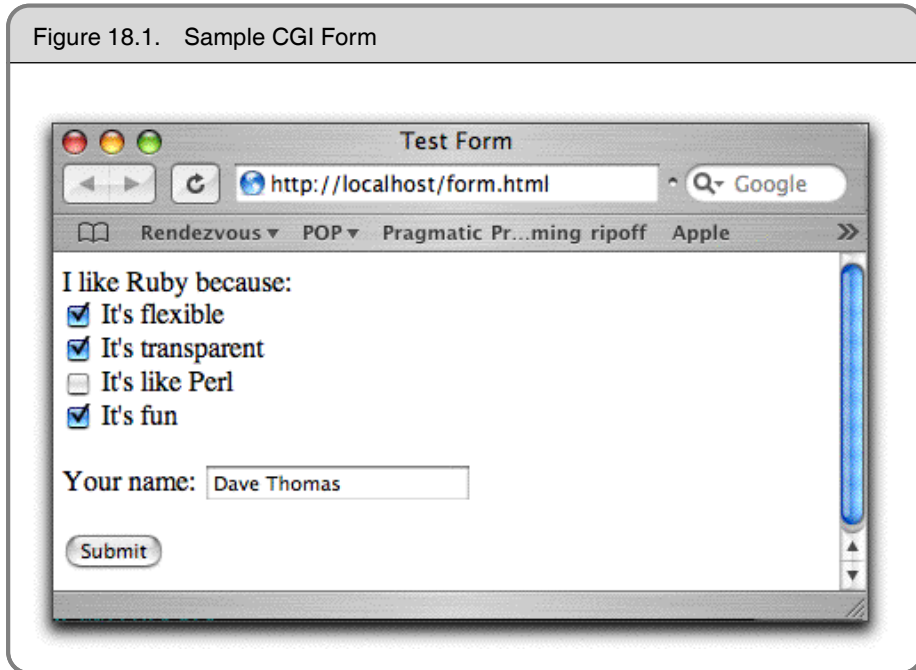

```
require 'cgi'
cgi = CGI.new
cgi.params → {"name"=>["Dave Thomas"],
 "reason"=>["flexible", "transparent",
 "fun"]}

cgi.params['name'] → ["Dave Thomas"]
cgi.params['reason'] → ["flexible", "transparent", "fun"]
cgi.params['name'] = [cgi['name'].upcase]
cgi.params → {"name"=>["DAVE THOMAS"],
 "reason"=>["flexible", "transparent",
 "fun"]}
```

You can determine if a particular parameter is present in a request using `CGI#has_key?`.

```
require 'cgi'
cgi = CGI.new
cgi.has_key?('name') → true
cgi.has_key?('age') → false
```

## Generating HTML

CGI contains a huge number of methods that can be used to create HTML—one method per element. To enable these methods, you must create a CGI object by calling `CGI.new`, passing in the required level of HTML. In these examples, we'll use `html3`.

To make element nesting easier, these methods take their content as code blocks. The code blocks should return a `String`, which will be used as the content for the element. For this example, we’ve added some gratuitous newlines to make the output fit on the page.

```
require 'cgi'
cgi = CGI.new("html3") # add HTML generation methods
cgi.out {
 cgi.html {
 cgi.head { "\n"+cgi.title{"This Is a Test"} } +
 cgi.body { "\n"+
 cgi.form {"\n"+
 cgi.hr +
 cgi.h1 { "A Form: " } + "\n"+
 cgi.textarea("get_text") + "\n"+
 cgi.br +
 cgi.submit
 }
 }
 }
}
```

*produces:*

```
Content-Type: text/html
Content-Length: 302

<!DOCTYPE HTML PUBLIC "-//W3C//DTD HTML 3.2 Final//EN"><HTML><HEAD>
<TITLE>This Is a Test</TITLE></HEAD><BODY>
<FORM METHOD="post" ENCTYPE="application/x-www-form-urlencoded">
<HR><H1>A Form: </H1>
<TEXTAREA NAME="get_text" ROWS="10" COLS="70"></TEXTAREA>

<INPUT TYPE="submit"></FORM></BODY></HTML>
```

This code will produce an HTML form titled “This Is a Test,” followed by a horizontal rule, a level-one header, a text input area, and finally a submit button. When the submit comes back, you’ll have a CGI parameter named `get_text` containing the text the user entered.

Although quite interesting, this method of generating HTML is fairly laborious and probably isn’t used much in practice. Most people seem to write the HTML directly, use a templating system, or use an application framework, such as Iowa. Unfortunately, we don’t have space here to discuss Iowa—have a look at the online documentation at <http://enigo.com/projects/iowa>, or look at Chapter 6 of *The Ruby Developer’s Guide* [FJN02]—but we can look at templating.

## Templating Systems

Templating systems allow you separate the presentation and logic of your application. It seems that just about everyone who writes a Web application using Ruby at some

point also writes a templating system: the RubyGarden wiki lists quite a few,<sup>1</sup> and even this list isn't complete. For now, let's just look at three: RDoc templates, Amrita, and erb/eruby.

## RDoc Templates

The RDoc documentation system (described in Chapter 16 on page 187) includes a very simple templating system that it uses to generate all its XML and HTML output. Because RDoc is distributed as part of standard Ruby, the templating system is available wherever Ruby 1.8.2 or later is installed. However, the templating system does not use conventional HTML or XML markup (as it is intended to be used to generate output in many different formats), so files marked up with RDoc templates may not be easy to edit using conventional HTML editing tools.

```
require 'rdoc/template'
HTML = %{{Hello, %name%}}
<p>
The reasons you gave were:

START:reasons
 %reason_name% (%rank%)
END:reasons

}
data = {
 'name' => 'Dave Thomas',
 'reasons' => [
 { 'reason_name' => 'flexible', 'rank' => '87' },
 { 'reason_name' => 'transparent', 'rank' => '76' },
 { 'reason_name' => 'fun', 'rank' => '94' },
]
}

t = TemplatePage.new(HTML)
t.write_html_on(STDOUT, data)
```

*produces:*

```
Hello, Dave Thomas.
<p>
The reasons you gave were:

 flexible (87)
 transparent (76)
 fun (94)

```

---

1. <http://www.rubygarden.org/ruby?HtmlTemplates>

The constructor is passed a string containing the template to be used. The method `write_html_on` is then passed a hash containing names and values. If the template contains the sequence `%xxxx%`, the hash is consulted, and the value corresponding to the name `xxx` is substituted in. If the template contains `START:yyy`, the hash value corresponding to `yyy` is assumed to be an array of hashes. The template lines between `START:yyy` and `END:yyy` are repeated for each element in that array. The templates also support conditions: lines between `IF:zzz` and `ENDIF:zzz` are included in the output only if the hash has a key `zzz`.

## Amrita

Amrita<sup>2</sup> is a library that generates HTML documents from a template that is itself valid HTML. This makes Amrita easy to use with existing HTML editors. It also means that Amrita templates display correctly as freestanding HTML pages.

Amrita uses the `id` tags in HTML elements to determine the values to be substituted. If the value corresponding to a given name is `nil` or `false`, the HTML element won't be included in the resulting output. If the value is an array, it iterates the corresponding HTML element.

```
require 'amrita/template'
include Amrita
HTML = %<p id="greeting" />
<p>The reasons you gave were:</p>

 <li id="reasons">,

}
data = {
 :greeting => 'Hello, Dave Thomas',
 :reasons => [
 { :reason_name => 'flexible', :rank => '87' },
 { :reason_name => 'transparent', :rank => '76' },
 { :reason_name => 'fun', :rank => '94' },
]
}
t = TemplateText.new(HTML)
t.prettyprint = true
t.expand(STDOUT, data)
```

*produces:*

```
<p>Hello, Dave Thomas</p>
<p>The reasons you gave were:</p>
```

---

2. <http://www.brain-tokyo.jp/research/amrita/rdocs/>



```

 flexible, 87
 transparent, 76
 fun, 94

```

## erb and eruby

So far we’ve looked at using Ruby to create HTML output, but we can turn the problem inside out; we can actually embed Ruby in an HTML document.

A number of packages allow you to embed Ruby statements in some other sort of a document, especially in an HTML page. Generically, this is known as “eRuby.” Specifically, several different implementations of eRuby exist, including `eruby` and `erb`. `eruby`, written by Shugo Maeda, is available for download from the Ruby Application Archive. `erb`, its little cousin, is written in pure Ruby and is included with the standard distribution. We’ll look at `erb` here.

Embedding Ruby in HTML is a very powerful concept—it basically gives us the equivalent of a tool such as ASP, JSP, or PHP, but with the full power of Ruby.

## Using erb

`erb` is normally used as a filter. Text within the input file is passed through untouched, with the following exceptions

Expression	Description
<code>&lt;% ruby code %&gt;</code>	Execute the Ruby code between the delimiters.
<code>&lt;%= ruby expression %&gt;</code>	Evaluate the Ruby expression, and replace the sequence with the expression’s value.
<code>&lt;## ruby code %&gt;</code>	The Ruby code between the delimiters is ignored (useful for testing).
<code>% line of ruby code</code>	A line that starts with a percent is assumed to contain just Ruby code.

You invoke `erb` as

```
erb [options] [document]
```

If the *document* is omitted, `eruby` will read from standard input. The command-line options for `erb` are shown in Table 18.1 on the following page.

Let’s look at some simple examples. We’ll run the `erb` executable on the following input.

```

% a = 99
<%= a %> bottles of beer...

```

Table 18.1. Command-line options for erb

Option	Description
-d	Sets \$DEBUG to true.
-Kkcode	Specifies an alternate encoding system (see page 169).
-n	Display resulting Ruby script (with line numbers).
-r library	Loads the named library.
-P	Doesn't do erb processing on lines starting %.
-S level	Sets the <i>safe level</i> .
-T mode	Sets the <i>trim mode</i> .
-v	Enables verbose mode.
-x	Displays resulting Ruby script.

The line starting with the percent sign simply executes the given Ruby statement. The next line contains the sequence `<% a %>`, which substitutes in the value of `a`.

```
erb f1.erb
```

*produces:*

```
99 bottles of beer...
```

`erb` works by rewriting its input as a Ruby script and then executing that script. You can see the Ruby that `erb` generates using the `-n` or `-x` option.

```
erb -x f1.erb
```

*produces:*

```
_erbout = ''; a = 99
_erbout.concat((a).to_s); _erbout.concat " bottles of beer...\n"
_erbout
```

Notice how `erb` builds a string, `_erbout`, containing both the static strings from the template and the results of executing expressions (in this case the value of `a`).

Of course, you can embed Ruby within a more complex document type, such as HTML. Figure 18.2 on page 232 shows a couple of loops in an HTML document.

## Installing eruby in Apache

If you want to use `erb`-like page generation for a Web site that gets a reasonable amount of traffic, you'll probably want to switch across to using `eruby`, which has better performance. You can then configure the Apache Web server to automatically parse Ruby-embedded documents using `eRuby`, much in the same way that PHP does. You create Ruby-embedded files with an `.rhtml` suffix and configure the Web server to run the `eruby` executable on these documents to produce the desired HTML output.

To use eruby with the Apache Web server, you need to perform the following steps.

1. Copy the eruby binary to the cgi-bin directory.
2. Add the following two lines to httpd.conf.

```
AddType application/x-httpd-eruby .rhtml
Action application/x-httpd-eruby /cgi-bin/eruby
```

3. If desired, you can also add or replace the DirectoryIndex directive such that it includes index.rhtml. This lets you use Ruby to create directory listings for directories that do not contain an index.html. For instance, the following directive would cause the embedded Ruby script index.rhtml to be searched for and served if neither index.html nor index.shtml existed in a directory.

```
DirectoryIndex index.html index.shtml index.rhtml
```

Of course, you could also simply use a sitewide Ruby script as well.

```
DirectoryIndex index.html index.shtml /cgi-bin/index.rb
```

## Cookies

Cookies are a way of letting Web applications store their state on the user's machine. Frowned upon by some, cookies are still a convenient (if unreliable) way of remembering session information.

The Ruby CGI class handles the loading and saving of cookies for you. You can access the cookies associated with the current request using the CGI#cookies method, and you can set cookies back into the browser by setting the cookies parameter of CGI#out to reference either a single cookie or an array of cookies.

```
#!/usr/bin/ruby
COOKIE_NAME = 'chocolate chip'
require 'cgi'
cgi = CGI.new
values = cgi.cookies[COOKIE_NAME]
if values.empty?
 msg = "It looks as if you haven't visited recently"
else
 msg = "You last visited #{values[0]}"
end
cookie = CGI::Cookie.new(COOKIE_NAME, Time.now.to_s)
cookie.expires = Time.now + 30*24*3600 # 30 days
cgi.out("cookie" => cookie) { msg }
```

Figure 18.2. Erb processing a file with loops

```

<!DOCTYPE HTML PUBLIC "-//W3C//DTD HTML 4.01//EN">
<html>
<head>
<title>eruby example</title>
</head>
<body>
<h1>Enumeration</h1>

%5.times do |i|
 number <%=i%>
%end

<h1>"Environment variables starting with "T"</h1>
<table>
%ENV.keys.grep(/^T/).each do |key|
 <tr><td><%=key%></td><td><%=ENV[key]%></td></tr>
%end
</table>
</body>
</html>

```

*produces:*

```

<!DOCTYPE HTML PUBLIC "-//W3C//DTD HTML 4.01//EN">
<html>
<head>
<title>eruby example</title>
</head>
<body>
<h1>Enumeration</h1>

 number 0
 number 1
 number 2
 number 3
 number 4

<h1>"Environment variables starting with "T"</h1>
<table>
 <tr><td>TERM_PROGRAM</td><td>iTerm.app</td></tr>
 <tr><td>TERM</td><td>xterm-color</td></tr>
</table>
</body>
</html>

```

## Sessions

Cookies by themselves still need a bit of work to be useful. We really want *session*: information that persists between requests from a particular Web browser. Sessions are handled by class `CGI::Session`, which uses cookies but provides a higher-level abstraction.

As with cookies, sessions emulate a hashlike behavior, letting you associate values with keys. Unlike cookies, sessions store the majority of their data on the server, using the browser-resident cookie simply as a way of uniquely identifying the server-side data. Sessions also give you a choice of storage techniques for this data: it can be held in regular files, in a PStore (see the description on page 698), in memory, or even in your own customized store.

Sessions should be closed after use, as this ensures that their data is written out to the store. When you've permanently finished with a session, you should delete it.

```
require 'cgi'
require 'cgi/session'
cgi = CGI.new("html3")
sess = CGI::Session.new(cgi,
 "session_key" => "rubyweb",
 "prefix" => "web-session."
)

if sess['lastaccess']
 msg = "You were last here #{sess['lastaccess']}."
else
 msg = "Looks like you haven't been here for a while"
end

count = (sess["accesscount"] || 0).to_i
count += 1
msg << "<p>Number of visits: #{count}"
sess["accesscount"] = count
sess["lastaccess"] = Time.now.to_s
sess.close

cgi.out {
 cgi.html {
 cgi.body {
 msg
 }
 }
}
```

1.8

The code in the previous example used the default storage mechanism for sessions: persistent data was stored in files in your default temporary directory (see `Dir.tmpdir`). The filenames will all start `web-session.` and will end with a hashed version of the session number. See `ri CGI::Session` for more information.

## Improving Performance

You can use Ruby to write CGI programs for the Web, but, as with most CGI programs, the default configuration has to start a new copy of Ruby with every `cgi-bin` page access. That's expensive in terms of machine utilization and can be painfully slow for Web surfers. The Apache Web server solves this problem by supporting loadable *modules*.

Typically, these modules are dynamically loaded and become part of the running Web server process—you have no need to spawn another interpreter over and over again to service requests; the Web server *is* the interpreter.

And so we come to `mod_ruby` (available from the archives), an Apache module that links a full Ruby interpreter into the Apache Web server itself. The README file included with `mod_ruby` provides details on how to compile and install it.

Once installed and configured, you can run Ruby scripts pretty much as you could without `mod_ruby`, except that now they will come up much faster. You can also take advantage of the extra facilities that `mod_ruby` provides (such as tight integration into Apache's request handling).

You have some things to watch, however. Because the interpreter remains in memory between requests, it may end up handling requests from multiple applications. It's possible for libraries in these applications to clash (particularly if different libraries contain classes with the same name). You also cannot assume that the same interpreter will handle the series of requests from one browser's session—Apache will allocate handler processes using its internal algorithms.

Some of these issues are resolved using the FastCGI protocol. This is an interesting hack, available to all CGI-style programs, not just Ruby. It uses a very small proxy program, typically running as an Apache module. When requests are received, this proxy then forwards them to a particular long-running process that acts like a normal CGI script. The results are fed back to the proxy, and then back to the browser. FastCGI has the same advantages as running `mod_ruby`, as the interpreter is always running in the background. It also gives you more control over how requests are allocated to interpreters. You'll find more information at <http://www.fastcgi.com>.

## Choice of Web Servers

### 1.8

So far, we've been running Ruby scripts under the control of the Apache Web server. However, Ruby 1.8 and later comes bundled with WEBrick, a flexible, pure-Ruby HTTP server toolkit. Basically, it's an extensible plug-in-based framework that lets you write servers to handle HTTP requests and responses. Here's a basic HTTP server that serves documents and directory indexes.

```
#!/usr/bin/ruby
require 'webrick'
include WEBrick
s = HTTPServer.new(
 :Port => 2000,
 :DocumentRoot => File.join(Dir.pwd, "/html")
)
trap("INT") { s.shutdown }
s.start
```

The `HTTPServer` constructor creates a new Web server on port 2000. The code sets the document root to be the `html/` subdirectory of the current directory. It then uses `Kernel.trap` to arrange to shut down tidily on interrupts before starting the server running. If you point your browser at <http://localhost:2000>, you should see a listing of your `html` subdirectory.

WEBrick can do far more than serve static content. You can use it just like a Java servlet container. The following code mounts a simple servlet at the location `/hello`. As requests arrive, the `do_GET` method is invoked. It uses the response object to display the user agent information and parameters from the request.

```
#!/usr/bin/ruby
require 'webrick'
include WEBrick
s = HTTPServer.new(:Port => 2000)
class HelloServlet < HTTPServlet::AbstractServlet
 def do_GET(req, res)
 res['Content-Type'] = "text/html"
 res.body = %{
 <html><body>
 Hello. You're calling from a #{req['User-Agent']}
 <p>
 I see parameters: #{req.query.keys.join(', ')}
 </body></html>
 }
 end
end
s.mount("/hello", HelloServlet)
trap("INT"){ s.shutdown }
s.start
```

More information on WEBrick is available from <http://www.webrick.org>. There you'll find links to a set of useful servlets, including one that lets you write SOAP servers in Ruby.

## SOAP and Web Services

1.8

Speaking of SOAP, Ruby now comes with an implementation of SOAP.<sup>3</sup> This lets you write both servers and clients using Web services. By their nature, these applications can operate both locally and remotely across a network. SOAP applications are also unaware of the implementation language of their network peers, so SOAP is a convenient way of interconnecting Ruby applications with those written in languages such as Java, Visual Basic, or C++.

SOAP is basically a marshaling mechanism which uses XML to send data between two nodes in a network. It is typically used to implement remote procedure calls, RPCs, between distributed processes. A SOAP server publishes one or more interfaces. These interfaces are defined in terms of data types and methods that use those types. SOAP clients then create local proxies that SOAP connects to interfaces on the server. A call to a method on the proxy is then passed to the corresponding interface on the server. Return values generated by the method on the server are passed back to the client via the proxy.

Let's start with a trivial SOAP service. We'll write an object that does interest calculations. Initially, it offers a single method, `compound`, that determines compound interest given a principal, an interest rate, the number of times interested is compounded per year, and the number of years. For management purposes, we'll also keep track of how many times this method was called and make that count available via an accessor. Note that this class is just regular Ruby code—it doesn't know that it's running in a SOAP environment.

```
class InterestCalculator
 attr_reader :call_count
 def initialize
 @call_count = 0
 end
 def compound(principal, rate, freq, years)
 @call_count += 1
 principal*(1.0 + rate/freq)**(freq*years)
 end
end
```

Now we'll make an object of this class available via a SOAP server. This will enable client applications to call the object's methods over the network. We're using the stand-alone server here, which is convenient when testing, as we can run it from the command line. You can also run Ruby SOAP servers as CGI scripts or under `mod_ruby`.

---

3. SOAP once stood for Simple Object Access Protocol. When folks could no longer stand the irony, the acronym was dropped, and now SOAP is just a name.



```

require 'soap/rpc/standaloneServer'
require 'interestcalc'
NS = 'http://pragprog.com/InterestCalc'
class Server2 < SOAP::RPC::StandaloneServer
 def on_init
 calc = InterestCalculator.new
 add_method(calc, 'compound', 'principal', 'rate', 'freq', 'years')
 add_method(calc, 'call_count')
 end
end
svr = Server2.new('Calc', NS, '0.0.0.0', 12321)
trap('INT') { svr.shutdown }
svr.start

```

This code defines a class which implements a standalone SOAP server. When it is initialized, the class creates a `InterestCalculator` object (an instance of the class we just wrote). It then uses `add_method` to add the two methods implemented by this class, `compound` and `call_count`. Finally, the code creates and runs an instance of this server class. The parameters to the constructor are the name of the application, the default namespace, the address of the interface to use, and the port.

We then need to write some client code to access this server. The client creates a local proxy for the `InterestCalculator` service on the server, adds the methods it wants to use, and then calls them.

```

require 'soap/rpc/driver'
proxy = SOAP::RPC::Driver.new("http://localhost:12321",
 "http://pragprog.com/InterestCalc")
proxy.add_method('compound', 'principal', 'rate', 'freq', 'years')
proxy.add_method('call_count')
puts "Call count: #{proxy.call_count}"
puts "5 years, compound annually: #{proxy.compound(100, 0.06, 1, 5)}"
puts "5 years, compound monthly: #{proxy.compound(100, 0.06, 12, 5)}"
puts "Call count: #{proxy.call_count}"

```

To test this, we can run the server in one console window (the output here has been reformatted slightly to fit the width of this page).

```

% ruby server.rb
I, [2004-07-26T10:55:51.629451 #12327] INFO
 -- Calc: Start of Calc.
I, [2004-07-26T10:55:51.633755 #12327] INFO
 -- Calc: WEBrick 1.3.1
I, [2004-07-26T10:55:51.635146 #12327] INFO
 -- Calc: ruby 1.8.2 (2004-07-26) [powerpc-darwin]
I, [2004-07-26T10:55:51.639347 #12327] INFO
 -- Calc: WEBrick::HTTPServer#start: pid=12327 port=12321

```

We then run the client in another window.

```
% ruby client.rb
Call count: 0
5 years, compound annually: 133.82255776
5 years, compound monthly: 134.885015254931
Call count: 2
```

Looking good! Flush with success, we call all our friends over and run it again.

```
% ruby client.rb
Call count: 2
5 years, compound annually: 133.82255776
5 years, compound monthly: 134.885015254931
Call count: 4
```

Notice how the call count now starts at two the second time we run the client. The server creates a single `InterestCalculator` object to service incoming requests, and this object is reused for each request.

## SOAP and Google

Obviously the real benefit of SOAP is the way it lets you interoperate with other services on the Web. As an example, let's write some Ruby code to send queries to Google's Web API.

Before sending queries to Google, you need a developer key. This is available from Google—go to <http://www.google.com/apis> and follow the instructions in step 2, *Create a Google Account*. After you fill in your e-mail address and supply a password, Google will send you a developer key. In the following examples, we'll assume that you've stored this key in the file `.google_key` in your home directory.

Let's start at the most basic level. Looking at the documentation for the Google API method `doGoogleSearch`, we discover it has ten (!) parameters.

<code>key</code>	The developer key
<code>q</code>	The query string
<code>start</code>	The index of the first required result
<code>maxResults</code>	The maximum number of results to return per query
<code>filter</code>	If enabled, compresses results so that similar pages and pages from the same domain are only shown once
<code>restrict</code>	Restricts the search to a subset of the Google Web index
<code>safeSearch</code>	If enabled, removes possible adult content from the results
<code>lr</code>	Restricts the search to documents in a given set of languages
<code>ie</code>	Ignored (was input encoding)
<code>oe</code>	Ignored (was output encoding)

We can use the `add_method` call to construct a SOAP proxy for the `doGoogleSearch` method. The following example does just that, printing out the first entry returned if you search Google for the term *pragmatic*.

```

require 'soap/rpc/driver'
require 'cgi'
endpoint = 'http://api.google.com/search/beta2'
namespace = 'urn:GoogleSearch'
soap = SOAP::RPC::Driver.new(endpoint, namespace)
soap.add_method('doGoogleSearch', 'key', 'q', 'start',
 'maxResults', 'filter', 'restrict',
 'safeSearch', 'lr', 'ie', 'oe')

query = 'pragmatic'
key = File.read(File.join(ENV['HOME'], ".google_key")).chomp
result = soap.doGoogleSearch(key, query, 0, 1, false, nil,
 false, nil, nil, nil)

printf "Estimated number of results is %d.\n",
 result.estimatedTotalResultsCount

printf "Your query took %6f seconds.\n", result.searchTime
first = result.resultElements[0]
puts first.title
puts first.URL
puts CGI.unescapeHTML(first.snippet)

```

Run this, and you'll see something such as the following (notice how the query term has been highlighted by Google).

```

Estimated number of results is 550000.
Your query took 0.123762 seconds.
The Pragmatic Programmers, LLC
http://www.pragmaticprogrammer.com/
Home of Andrew Hunt and David Thomas's best-selling book 'The
Pragmatic Programmer'
 and The 'Pragmatic Starter Kit
(tm)' series. ... The Pragmatic Bookshelf TM. ...

```

However, SOAP allows for the dynamic discovery of the interface of objects on the server. This is done using WSDL, the Web Services Description Language. A WSDL file is an XML document that describes the types, methods, and access mechanisms for a Web services interface. SOAP clients can read WSDL files to create the interfaces to a server automatically.

The Web page <http://api.google.com/GoogleSearch.wsdl> contains the WSDL describing the Google interface. We can alter our search application to read this WSDL, which removes the need to add the doGoogleSearch method explicitly.

```

require 'soap/wsdlDriver'
require 'cgi'
WSDL_URL = "http://api.google.com/GoogleSearch.wsdl"
soap = SOAP::WSDLDriverFactory.new(WSDL_URL).createDriver
query = 'pragmatic'
key = File.read(File.join(ENV['HOME'], ".google_key")).chomp
result = soap.doGoogleSearch(key, query, 0, 1, false,
 nil, false, nil, nil, nil)

```

```

printf "Estimated number of results is %d.\n",
 result.estimatedTotalResultsCount
printf "Your query took %6f seconds.\n", result.searchTime
first = result.resultElements[0]
puts first.title
puts first.URL
puts CGI.unescapeHTML(first.snippet)

```

Finally, we can take this a step further using Ian Macdonald’s Google library (available in the RAA). It encapsulates the Web services API behind a nice interface (nice if for no other reason than it eliminates the need for all those extra parameters). The library also has methods to construct the date ranges and other restrictions on a Google query and provides interfaces to the Google cache and the spell-checking facility. The following code is our “pragmatic” search using Ian’s library.

```

require 'google'
require 'cgi'
key = File.read(File.join(ENV['HOME'], ".google_key")).chomp
google = Google::Search.new(key)
result = google.search('pragmatic')
printf "Estimated number of results is %d.\n",
 result.estimatedTotalResultsCount
printf "Your query took %6f seconds.\n", result.searchTime
first = result.resultElements[0]
puts first.title
puts first.url
puts CGI.unescapeHTML(first.snippet)

```

## More Information

Ruby Web programming is a big topic. To dig deeper, you may want to look at Chapter 9 in *The Ruby Way* [Ful01], where you’ll find many examples of network and Web programming, and Chapter 6 of *The Ruby Developer’s Guide* [FJN02], where you’ll find some good examples of structuring CGI applications, along with some example Iowa code.

If SOAP strikes you being complex, you may want to look at using XML-RPC, which is described briefly on page 736.

A number of other Ruby Web development frameworks are available on the ’net. This is a dynamic area: new contenders appear constantly, and it is hard for a printed book to be definitive. However, two frameworks that are currently attracting mindshare in the Ruby community are

- Rails (<http://www.rubyonrails.org>), and
- CGIKit ([http://www.spice-of-life.net/cgikit/index\\_en.html](http://www.spice-of-life.net/cgikit/index_en.html)).

# Ruby Tk

---

The Ruby Application Archive contains several extensions that provide Ruby with a graphical user interface (GUI), including extensions for Fox, GTK, and others.

The Tk extension is bundled in the main distribution and works on both Unix and Windows systems. To use it, you need to have Tk installed on your system. Tk is a large system, and entire books have been written about it, so we won't waste time or resources by delving too deeply into Tk itself but instead concentrate on how to access Tk features from Ruby. You'll need one of these reference books in order to use Tk with Ruby effectively. The binding we use is closest to the Perl binding, so you probably want to get a copy of *Learning Perl/Tk* [Wal99] or *Perl/Tk Pocket Reference* [Lid98].

Tk works along a composition model—that is, you start by creating a container (such as a `TkFrame` or `TkRoot`) and then create the widgets (another name for GUI components) that populate it, such as buttons or labels. When you are ready to start the GUI, you invoke `Tk.mainloop`. The Tk engine then takes control of the program, displaying widgets and calling your code in response to GUI events.

## Simple Tk Application

A simple Tk application in Ruby may look something like this.

```
require 'tk'
root = TkRoot.new { title "Ex1" }
TkLabel.new(root) do
 text 'Hello, World!'
 pack { padx 15 ; pady 15; side 'left' }
end
Tk.mainloop
```



Let's look at the code a little more closely. After loading the `tk` extension module, we create a root-level frame using `TkRoot.new`. We then make a `TkLabel` widget as a

child of the root frame, setting several options for the label. Finally, we pack the root frame and enter the main GUI event loop.

It's a good habit to specify the root explicitly, but you could leave it out—along with the extra options—and boil this down to a three-liner.

```
require 'tk'
TkLabel.new { text 'Hello, World!'; pack }
Tk.mainloop
```

That's all there is to it! Armed with one of the Perl/Tk books we reference at the start of this chapter, you can now produce all the sophisticated GUIs you need. But then again, if you'd like to stick around for some more details, here they come.

## Widgets

Creating widgets is easy. Take the name of the widget as given in the Tk documentation and add a Tk to the front of it. For instance, the widgets Label, Button, and Entry become the classes TkLabel, TkButton, and TkEntry. You create an instance of a widget using new, just as you would any other object. If you don't specify a parent for a given widget, it will default to the root-level frame. We usually want to specify the parent of a given widget, along with many other options—color, size, and so on. We also need to be able to get information back from our widgets while our program is running by setting up *callbacks* (routines invoked when certain events happen) and sharing data.

## Setting Widget Options

If you look at a Tk reference manual (the one written for Perl/Tk, for example), you'll notice that options for widgets are usually listed with a hyphen—as a command-line option would be. In Perl/Tk, options are passed to a widget in a Hash. You can do that in Ruby as well, but you can also pass options using a code block; the name of the option is used as a method name within the block and arguments to the option appear as arguments to the method call. Widgets take a parent as the first argument, followed by an optional hash of options or the code block of options. Thus, the following two forms are equivalent.

```
TkLabel.new(parent_widget) do
 text 'Hello, World!'
 pack('padx' => 5,
 'pady' => 5,
 'side' => 'left')
end
or
TkLabel.new(parent_widget, 'text' => 'Hello, World!').pack(...)
```

One small caution when using the code block form: the scope of variables is not what you think it is. The block is actually evaluated in the context of the widget's object, not the caller's. This means that the caller's instance variables will not be available in the block, but local variables from the enclosing scope and globals will be (not that you use global variables, of course.) We'll show option passing using both methods in the examples that follow.

Distances (as in the `padx` and `pady` options in these examples) are assumed to be in pixels but may be specified in different units using one of the suffixes `c` (centimeter), `i` (inch), `m` (millimeter), or `p` (point). "12p", for example, is twelve points.

## Getting Widget Data

We can get information back from widgets by using callbacks and by binding variables.

Callbacks are very easy to set up. The `command` option (shown in the `TkButton` call in the example that follows) takes a `Proc` object, which will be called when the callback fires. Here we pass the `proc` in as a block associated with the method call, but we could also have used `Kernel.lambda` to generate an explicit `Proc` object.

```
require 'tk'
TkButton.new do
 text "EXIT"
 command { exit }
 pack('side'=>'left', 'padx'=>10, 'pady'=>10)
end
Tk.mainloop
```

We can also bind a Ruby variable to a `Tk` widget's value using a `TkVariable` proxy. This arranges things so that whenever the widget's value changes, the Ruby variable will automatically be updated, and whenever the variable is changed, the widget will reflect the new value.

We show this in the following example. Notice how the `TkCheckButton` is set up; the documentation says that the `variable` option takes a *var reference* as an argument. For this, we create a `Tk` variable reference using `TkVariable.new`. Accessing `mycheck.value` will return the string "0" or "1" depending on whether the checkbox is checked. You can use the same mechanism for anything that supports a `var reference`, such as radio buttons and text fields.

```
require 'tk'
packing = { 'padx'=>5, 'pady'=>5, 'side' => 'left' }
checked = TkVariable.new
def checked.status
 value == "1" ? "Yes" : "No"
end
```

```

status = TkLabel.new do
 text checked.status
 pack(packing)
end
TkCheckButton.new do
 variable checked
 pack(packing)
end
TkButton.new do
 text "Show status"
 command { status.text(checked.status) }
 pack(packing)
end
Tk.mainloop

```

## Setting/Getting Options Dynamically

In addition to setting a widget's options when it's created, you can reconfigure a widget while it's running. Every widget supports the `configure` method, which takes a Hash or a code block in the same manner as `new`. We can modify the first example to change the label text in response to a button click.

```

require 'tk'
root = TkRoot.new { title "Ex3" }
top = TkFrame.new(root) { relief 'raised'; border 5 }
lbl = TkLabel.new(top) do
 justify 'center'
 text 'Hello, World!'
 pack('padx'=>5, 'pady'=>5, 'side' => 'top')
end
TkButton.new(top) do
 text "Ok"
 command { exit }
 pack('side'=>'left', 'padx'=>10, 'pady'=>10)
end
TkButton.new(top) do
 text "Cancel"
 command { lbl.configure('text'=>"Goodbye, Cruel World!") }
 pack('side'=>'right', 'padx'=>10, 'pady'=>10)
end
top.pack('fill'=>'both', 'side' =>'top')
Tk.mainloop

```

Now when the Cancel button is clicked, the text in the label will change immediately from “Hello, World!” to “Goodbye, Cruel World!”

You can also query widgets for particular option values using `cget`.



```

require 'tk'
b = TkButton.new do
 text "OK"
 justify "left"
 border 5
end
b.cget('text') → "OK"
b.cget('justify') → "left"
b.cget('border') → 5

```

## Sample Application

Here's a slightly longer example, showing a genuine application—a pig latin generator. Type in the phrase such as **Ruby rules**, and the **Pig It** button will instantly translate it into pig latin.

```

require 'tk'
class PigBox
 def pig(word)
 leading_cap = word =~ /^[A-Z]/
 word.downcase!
 res = case word
 when /^[aeiouy]/
 word+"way"
 when /^[^aeiouy]+)(.*)/
 $2+$1+"ay"
 else
 word
 end
 leading_cap ? res.capitalize : res
 end
 def show_pig
 @text.value = @text.value.split.collect{|w| pig(w)}.join(" ")
 end
 def initialize
 ph = { 'padx' => 10, 'pady' => 10 } # common options
 root = TkRoot.new { title "Pig" }
 top = TkFrame.new(root) { background "white" }
 TkLabel.new(top) {text 'Enter Text:' ; pack(ph) }
 @text = TkVariable.new
 TkEntry.new(top, 'textvariable' => @text).pack(ph)
 pig_b = TkButton.new(top) { text 'Pig It'; pack ph}
 pig_b.command { show_pig }
 exit_b = TkButton.new(top) {text 'Exit'; pack ph}
 exit_b.command { exit }
 top.pack('fill'=>'both', 'side' =>'top')
 end
end
PigBox.new
Tk.mainloop

```



### Geometry Management

In the example code in this chapter, you'll see references to the widget method `pack`. That's a very important call, as it turns out—leave it off and you'll never see the widget. `pack` is a command that tells the geometry manager to place the widget according to constraints that we specify. Geometry managers recognize three commands.

Command	Placement Specification
<code>pack</code>	Flexible, constraint-based placement
<code>place</code>	Absolute position
<code>grid</code>	Tabular (row/column) position

As `pack` is the most commonly used command, we'll use it in our examples.

## Binding Events

Our widgets are exposed to the real world; they get clicked, the mouse moves over them, the user tabs into them; all these things, and more, generate *events* that we can capture. You can create a *binding* from an event on a particular widget to a block of code, using the widget's `bind` method.

For instance, suppose we've created a button widget that displays an image. We'd like the image to change when the user's mouse is over the button.

```
require 'tk'
image1 = TkPhotoImage.new { file "img1.gif" }
image2 = TkPhotoImage.new { file "img2.gif" }
b = TkButton.new(@root) do
 image image1
 command { exit }
 pack
end
b.bind("Enter") { b.configure('image'=>image2) }
b.bind("Leave") { b.configure('image'=>image1) }
Tk.mainloop
```

First, we create two GIF image objects from files on disk, using `TkPhotoImage`. Next we create a button (very cleverly named “b”), which displays the image `image1`. We then bind the `Enter` event so that it dynamically changes the image displayed by the button to `image2` when the mouse is over the button, and the `Leave` event to revert back to `image1` when the mouse leaves the button.

This example shows the simple events Enter and Leave. But the named event given as an argument to bind can be composed of several substrings, separated with dashes, in the order *modifier-modifier-type-detail*. Modifiers are listed in the Tk reference and include Button1, Control, Alt, Shift, and so on. *Type* is the name of the event (taken from the X11 naming conventions) and includes events such as ButtonPress, KeyPress, and Expose. *Detail* is either a number from 1 to 5 for buttons or a keysym for keyboard input. For instance, a binding that will trigger on mouse release of button 1 while the control key is pressed could be specified as

```
Control-Button1-ButtonRelease
```

or

```
Control-ButtonRelease-1
```

The event itself can contain certain fields such as the time of the event and the *x* and *y* positions. bind can pass these items to the callback, using *event field codes*. These are used like printf specifications. For instance, to get the *x* and *y* coordinates on a mouse move, you'd specify the call to bind with three parameters. The second parameter is the Proc for the callback, and the third parameter is the event field string.

```
canvas.bind("Motion", lambda { |x, y| do_motion (x, y)}, "%x %y")
```

## Canvas

Tk provides a Canvas widget with which you can draw and produce PostScript output. Figure 19.1 on the following page shows a simple bit of code (adapted from the distribution) that will draw straight lines. Clicking and holding button 1 will start a line, which will be “rubber-banded” as you move the mouse around. When you release button 1, the line will be drawn in that position.

A few mouse clicks, and you've got an instant masterpiece.

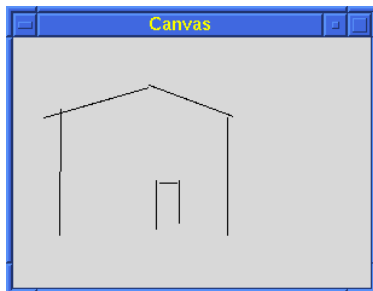

As they say, “We couldn’t find the artist, so we had to hang the picture. . . .”

Figure 19.1. Drawing on a Tk Canvas

```

require 'tk'

class Draw
 def do_press(x, y)
 @start_x = x
 @start_y = y
 @current_line = TkLine.new(@canvas, x, y, x, y)
 end

 def do_motion(x, y)
 if @current_line
 @current_line.coords @start_x, @start_y, x, y
 end
 end

 def do_release(x, y)
 if @current_line
 @current_line.coords @start_x, @start_y, x, y
 @current_line.fill 'black'
 @current_line = nil
 end
 end

 def initialize(parent)
 @canvas = TkCanvas.new(parent)
 @canvas.pack
 @start_x = @start_y = 0
 @canvas.bind("1", lambda { |e| do_press(e.x, e.y) })
 @canvas.bind("B1-Motion",
 lambda { |x, y| do_motion(x, y) }, "%x %y")
 @canvas.bind("ButtonRelease-1",
 lambda { |x, y| do_release(x, y) },
 "%x %y")
 end
end

root = TkRoot.new { title 'Canvas' }
Draw.new(root)
Tk.mainloop

```

## Scrolling

Unless you plan on drawing very small pictures, the previous example may not be all that useful. TkCanvas, TkListbox, and TkText can be set up to use scrollbars, so you can work on a smaller subset of the “big picture.”

Communication between a scrollbar and a widget is bidirectional. Moving the scrollbar means that the widget’s view has to change; but when the widget’s view is changed by some other means, the scrollbar has to change as well to reflect the new position.

Since we haven’t done much with lists yet, our scrolling example will use a scrolling list of text. In the following code fragment, we’ll start by creating a plain old TkListbox and an associated TkScrollbar. The scrollbar’s callback (set with `command`) will call the list widget’s `yview` method, which will change the value of the visible portion of the list in the *y* direction.

After that callback is set up, we make the inverse association: when the list feels the need to scroll, we’ll set the appropriate range in the scrollbar using `TkScrollbar#set`. We’ll use this same fragment in a fully functional program in the next section.

```
list_w = TkListbox.new(frame) do
 selectmode 'single'
 pack 'side' => 'left'
end
list_w.bind("ButtonRelease-1") do
 busy do
 filename = list_w.get(*list_w.curselection)
 tmp_img = TkPhotoImage.new { file filename }
 scale = tmp_img.height / 100
 scale = 1 if scale < 1
 image_w.copy(tmp_img, 'subsample' => [scale, scale])
 image_w.pack
 end
end
scroll_bar = TkScrollbar.new(frame) do
 command {|*args| list_w.yview *args }
 pack 'side' => 'left', 'fill' => 'y'
end
list_w.yscrollcommand {|first,last| scroll_bar.set(first,last) }
```

## Just One More Thing

We could go on about Tk for another few hundred pages, but that’s another book. The following program is our final Tk example—a simple GIF image viewer. You can select a GIF filename from the scrolling list, and a thumb nail version of the image will be displayed. We’ll point out just a *few* more things.

Have you ever used an application that creates a “busy cursor” and then forgets to reset it to normal? A neat trick in Ruby will prevent this from happening. Remember how `File.new` uses a block to ensure that the file is closed after it is used? We can do a similar thing with the method `busy`, as shown in the next example.

This program also demonstrates some simple `TkListbox` manipulations—adding elements to the list, setting up a callback on a mouse button release,<sup>1</sup> and retrieving the current selection.

So far, we’ve used `TkPhotoImage` to display images directly, but you can also zoom, subsample, and show portions of images as well. Here we use the `subsample` feature to scale down the image for viewing.

```
require 'tk'
class GifViewer
 def initialize(filelist)
 setup_viewer(filelist)
 end
 def run
 Tk.mainloop
 end
 def setup_viewer(filelist)
 @root = TkRoot.new {title 'Scroll List'}
 frame = TkFrame.new(@root)
 image_w = TkPhotoImage.new
 TkLabel.new(frame) do
 image image_w
 pack 'side' => 'right'
 end
 list_w = TkListbox.new(frame) do
 selectmode 'single'
 pack 'side' => 'left'
 end
 list_w.bind("ButtonRelease-1") do
 busy do
 filename = list_w.get(*list_w.curselection)
 tmp_img = TkPhotoImage.new { file filename }
 scale = tmp_img.height / 100
 scale = 1 if scale < 1
 image_w.copy(tmp_img, 'subsample' => [scale, scale])
 image_w.pack
 end
 end
 end
end
```



---

1. You probably want the button release, not the press, as the widget gets selected on the button press.

```

filelist.each do |name|
 list_w.insert('end', name) # Insert each file name into the list
end
scroll_bar = TkScrollbar.new(frame) do
 command {|*args| list_w.yview *args }
 pack 'side' => 'left', 'fill' => 'y'
end
list_w.yscrollcommand {|first,last| scroll_bar.set(first,last) }
frame.pack
end
Run a block with a 'wait' cursor
def busy
 @root.cursor "watch" # Set a watch cursor
 yield
ensure
 @root.cursor "" # Back to original
end
end
viewer = GifViewer.new(Dir["screenshots/gifs/*.gif"])
viewer.run

```

## Translating from Perl/Tk Documentation

That's it, you're on your own now. For the most part, you can easily translate the documentation given for Perl/Tk to Ruby. There are a few exceptions; some methods are not implemented, and some extra functionality is undocumented. Until a Ruby/Tk book comes out, your best bet is to ask on the newsgroup or read the source code.

But in general, it's pretty easy to see what's happening. Remember that options may be given as a hash, or in code block style, and the scope of the code block is within the TkWidget being used, not your class instance.

### Object Creation

In the Perl/Tk mapping, parents are responsible for creating their child widgets. In Ruby, the parent is passed as the first parameter to the widget's constructor.

```

Perl/Tk: $widget = $parent->Widget([option => value])
Ruby: widget = TkWidget.new(parent, option-hash)
 widget = TkWidget.new(parent) { code block }

```

You may not need to save the returned value of the newly created widget, but it's there if you do. Don't forget to pack a widget (or use one of the other geometry calls), or it won't be displayed.

## Options

```
Perl/Tk: -background => color
Ruby: 'background' => color
 { background color }
```

Remember that the code block scope is different.

## Variable References

```
Perl/Tk: -textvariable => \ $variable
 -textvariable => varRef
Ruby: ref = TkVariable.new
 'textvariable' => ref
 { textvariable ref }
```

Use `TkVariable` to attach a Ruby variable to a widget's value. You can then use the value accessors in `TkVariable` (`TkVariable#value` and `TkVariable#value=`) to affect the contents of the widget directly.



# Ruby and Microsoft Windows

---

Ruby runs in a number of different environments. Some of these are Unix-based, and others are based on the various flavors of Microsoft Windows. Ruby came from people who were Unix-centric, but over the years it has also developed a whole lot of useful features in the Windows world, too. In this chapter, we'll look at these features and share some secrets to using Ruby effectively under Windows.

## Getting Ruby for Windows

Two flavors of Ruby are available for the Windows environment.

The first is a version of Ruby that runs natively—that is, it is just another Windows application. The easiest way to get this distribution is to use the One-Click Installer, which loads a ready-made binary distribution onto your box. Follow the links from <http://rubyinstaller.rubyforge.org/> to get the latest version.

If you're feeling more adventurous, or if you need to compile in libraries that aren't supplied with the binary distribution, then you can build Ruby from source. You'll need the Microsoft VC++ compiler and associated tools to do this. Download the source of Ruby from <http://www.ruby-lang.org>, or use CVS to check out the latest development version. Then read the file `win32\README.win32` for instructions.

A second alternative uses an emulation layer called Cygwin. This provides a Unix-like environment on top of Windows. The Cygwin version of Ruby is the closest to Ruby running on Unix platforms, but running it means you must also install Cygwin. If you want to take this route, you can download the Cygwin version of Ruby from <http://ftp.ruby-lang.org/pub/ruby/binaries/cygwin/>. You'll also need Cygwin itself. The download link has a pointer to the required dynamic link library (DLL), or you can go to <http://www.cygwin.com> and download the full package (but be careful: you need to make sure the version you get is compatible with the Ruby you downloaded).

1.8

Which version to choose? When the first edition of this book was produced, the Cygwin version of Ruby was the distribution of choice. That situation has changed: the native build has become more and more functional over time, to the point where this is now our preferred Windows build of Ruby.

## Running Ruby Under Windows

You'll find two executables in the Ruby Windows distribution.

`ruby.exe` is meant to be used at a command prompt (a DOS shell), just as in the Unix version. For applications that read and write to the standard input and output, this is fine. But this also means that anytime you run `ruby.exe`, you'll get a DOS shell even if you don't want one—Windows will create a new command prompt window and display it while Ruby is running. This may not be appropriate behavior if, for example, you double-click a Ruby script that uses a graphical interface (such as Tk), or if you are running a Ruby script as a background task or from inside another program.

In these cases, you'll want to use `rubyw.exe`. It is the same as `ruby.exe` except that it does not provide standard in, standard out, or standard error and does not launch a DOS shell when run.

The installer (by default) sets file associations so that files with the extension `.rb` will automatically use `rubyw.exe`. By doing this, you can double-click Ruby scripts, and they will simply run without popping up a DOS shell.

## Win32API

If you plan on doing Ruby programming that needs to access some Windows 32 API functions directly, or that needs to use the entry points in some other DLLs, we've got good news for you—the Win32API library.

As an example, here's some code that's part of a larger Windows application used by our book fulfillment system to download and print invoices and receipts. A Web application generates a PDF file, which the Ruby script running on Windows downloads into a local file. The script then uses the `print` shell command under Windows to print this file.

```
arg = "ids=#{resp.intl_orders.join(",")}"
fname = "/temp/invoices.pdf"
site = Net::HTTP.new(HOST, PORT)
site.use_ssl = true
http_resp, = site.get2("/fulfill/receipt.cgi?" + arg,
 'Authorization' => 'Basic ' +
 ["name:passwd"].pack('m').strip)
```

```
File.open(fname, "wb") {|f| f.puts(http_resp.body) }
shell = Win32API.new("shell32", "ShellExecute",
 ['L', 'P', 'P', 'P', 'P', 'L'], 'L')
shell.Call(0, "print", fname, 0, 0, SW_SHOWNORMAL)
```

You create a Win32API object that represents a call to a particular DLL entry point by specifying the name of the function, the name of the DLL that contains the function, and the function signature (argument types and return type). In the previous example, the variable `shell` wraps the Windows function `ShellExecute` in the `shell32` DLL. It takes six parameters (a number, four string pointers, and a number) and returns a number. (These parameter types are described on page 734.) The resulting object can then be used to make the call to print the file that we downloaded.

Many of the arguments to DLL functions are binary structures of some form. Win32API handles this by using Ruby `String` objects to pass the binary data back and forth. You will need to pack and unpack these strings as necessary (see the example on page 734).

## Windows Automation

If groveling around in the low-level Windows API doesn't interest you, Windows Automation may—you can use Ruby as a client for Windows Automation thanks to a Ruby extension called WIN32OLE, written by Masaki Suketa. Win32OLE is part of the standard Ruby distribution.

1.8

Windows Automation allows an automation controller (a client) to issue commands and queries against an automation server, such as Microsoft Excel, Word, PowerPoint, and so on.

You can execute a method of an automation server by calling a method of the same name from a WIN32OLE object. For instance, you can create a new WIN32OLE client that launches a fresh copy of Internet Explorer and commands it to visit its home page.

```
ie = WIN32OLE.new('InternetExplorer.Application')
ie.visible = true
ie.gohome
```

You could also make it navigate to a particular page.

```
ie = WIN32OLE.new('InternetExplorer.Application')
ie.visible = true
ie.navigate("http://www.pragmaticprogrammer.com")
```

Methods that aren't known to WIN32OLE (such as `visible`, `gohome`, or `navigate`) are passed on to the WIN32OLE#`invoke` method, which sends the proper commands to the server.

## Getting and Setting Properties

You can set and get *properties* from the server using normal Ruby hash notation. For example, to set the Rotation property in an Excel chart, you could write

```
excel = WIN32OLE.new("excel.application")
excelchart = excel.Charts.Add()
...
excelchart['Rotation'] = 45
puts excelchart['Rotation']
```

An OLE object's parameters are automatically set up as attributes of the WIN32OLE object. This means you can set a parameter by assigning to an object attribute.

```
excelchart.rotation = 45
r = excelchart.rotation
```

The following example is a modified version of the sample file `excel2.rb` (found in the `ext/win32/samples` directory). It starts Excel, creates a chart, and then rotates it on the screen. Watch out, Pixar!

```
require 'win32ole'
-4100 is the value for the Excel constant xl3DColumn.
ChartTypeVal = -4100;
excel = WIN32OLE.new("excel.application")
Create and rotate the chart
excel['Visible'] = TRUE
excel.Workbooks.Add()
excel.Range("a1")['Value'] = 3
excel.Range("a2")['Value'] = 2
excel.Range("a3")['Value'] = 1
excel.Range("a1:a3").Select()
excelchart = excel.Charts.Add()
excelchart['Type'] = ChartTypeVal
30.step(180, 5) do |rot|
 excelchart.rotation = rot
 sleep(0.1)
end
excel.ActiveWorkbook.Close(0)
excel.Quit()
```

## Named Arguments

Other automation client languages such as Visual Basic have the concept of *named arguments*. Suppose you had a Visual Basic routine with the signature

```
Song(artist, title, length): rem Visual Basic
```

Instead of calling it with all three arguments in the order specified, you could use named arguments.

```
Song title := 'Get It On': rem Visual Basic
```

This is equivalent to the call `Song(nil, 'Get It On', nil)`.

In Ruby, you can use this feature by passing a hash with the named arguments.

```
Song.new('title' => 'Get It On')
```

## for each

Where Visual Basic has a “for each” statement to iterate over a collection of items in a server, a WIN32OLE object has an `each` method (which takes a block) to accomplish the same thing.

```
require 'win32ole'
excel = WIN32OLE.new("excel.application")
excel.Workbooks.Add
excel.Range("a1").Value = 10
excel.Range("a2").Value = 20
excel.Range("a3").Value = "=a1+a2"
excel.Range("a1:a3").each do |cell|
 p cell.Value
end
```

## Events

Your automation client written in Ruby can register itself to receive events from other programs. This is done using the `WIN32OLE_EVENT` class. This example (based on code from the Win32OLE 0.1.1 distribution) shows the use of an event sink that logs the URLs that a user browses to when using Internet Explorer.

```
require 'win32ole'
$urls = []
def navigate(url)
 $urls << url
end
def stop_msg_loop
 puts "IE has exited..."
 throw :done
end
def default_handler(event, *args)
 case event
 when "BeforeNavigate"
 puts "Now Navigating to #{args[0]}..."
 end
end
```

```

ie = WIN32OLE.new('InternetExplorer.Application')
ie.visible = TRUE
ie.gohome
ev = WIN32OLE_EVENT.new(ie, 'DWebBrowserEvents')
ev.on_event {|*args| default_handler(*args)}
ev.on_event("NavigateComplete") {|url| navigate(url)}
ev.on_event("Quit") {|*args| stop_msg_loop}
catch(:done) do
 loop do
 WIN32OLE_EVENT.message_loop
 end
end
puts "You Navigated to the following URLs: "
$url.each_with_index do |url, i|
 puts "(#{i+1}) #{url}"
end

```

## Optimizing

As with most (if not all) high-level languages, it can be all too easy to churn out code that is unbearably slow, but that can be easily fixed with a little thought.

With WIN32OLE, you need to be careful with unnecessary dynamic lookups. Where possible, it is better to assign a WIN32OLE object to a variable and then reference elements from it, rather than creating a long chain of “.” expressions.

For example, instead of writing

```

workbook.Worksheets(1).Range("A1").value = 1
workbook.Worksheets(1).Range("A2").value = 2
workbook.Worksheets(1).Range("A3").value = 4
workbook.Worksheets(1).Range("A4").value = 8

```

we can eliminate the common subexpressions by saving the first part of the expression to a temporary variable and then make calls from that variable.

```

worksheet = workbook.Worksheets(1)
worksheet.Range("A1").value = 1
worksheet.Range("A2").value = 2
worksheet.Range("A3").value = 4
worksheet.Range("A4").value = 8

```

You can also create Ruby stubs for a particular Windows type library. These stubs wrap the OLE object in a Ruby class with one method per entry point. Internally, the stub uses the entry point’s number, not name, which speeds access.

Generate the wrapper class using the `olegen.rb` script in the `ext\win32ole\samples` directory, giving it the name of the type library to reflect on.

```

C:\> ruby olegen.rb 'NetMeeting 1.1 Type Library' >netmeeting.rb

```

The external methods and events of the type library are written as Ruby methods to the given file. You can then include it in your programs and call the methods directly. Let's try some timings.

```
require 'netmeeting'
require 'benchmark'
include Benchmark
bmbm(10) do |test|
 test.report("Dynamic") do
 nm = WIN32OLE.new('NetMeeting.App.1')
 10000.times { nm.Version }
 end
 test.report("Via proxy") do
 nm = NetMeeting_App_1.new
 10000.times { nm.Version }
 end
end
```

*produces:*

```
Rehearsal -----
Dynamic 0.600000 0.200000 0.800000 (1.623000)
Via proxy 0.361000 0.140000 0.501000 (0.961000)
----- total: 1.301000sec

 user system total real
Dynamic 0.471000 0.110000 0.581000 (1.522000)
Via proxy 0.470000 0.130000 0.600000 (0.952000)
```

The proxy version is more than 40 percent faster than the code that does the dynamic lookup.

## More Help

If you need to interface Ruby to Windows NT, 2000, or XP, you may want to have a look at Daniel Berger's Win32Utils project (<http://rubyforge.org/projects/win32utils/>). There you'll find modules for interfacing to the Windows' clipboard, event log, scheduler, and so on.

Also, the DL library (described briefly on page 648) allows Ruby programs to invoke methods in dynamically loaded shared objects. On Windows, this means that your Ruby code can load and invoke entry points in a Windows DLL. For example, the following code, taken from the DL source code in the standard Ruby distribution, pops up a message box on a Windows machine, and determines which button the user clicked.

```
require 'dl'
User32 = DL.dlopen("user32")
MB_OKCANCEL = 1
```

```
message_box = User32['MessageBoxA', 'ILSSI']
r, rs = message_box.call(0, 'OK?', 'Please Confirm', MB_OKCANCEL)
case r
when 1
 print("OK!\n")
when 2
 print("Cancel!\n")
end
```

This code opens the User32 DLL. It then creates a Ruby object, `message_box`, that wraps the `MessageBoxA` entry point. The second parameter, "ILSSI", declares that the method returns an `Integer`, and takes a `Long`, two `Strings`, and an `Integer` as parameters.

The wrapper object is then used to call the message box entry point in the DLL. The return values are the result (in this case, the identifier of the button pressed by the user) and an array of the parameters passed in (which we ignore).



# Extending Ruby

---

It is easy to extend Ruby with new features by writing code in Ruby. But every now and then you need to interface to things at a lower level. Once you start adding in low-level code written in C, the possibilities are endless. Having said this, the stuff in this chapter is pretty advanced and should probably be skipped the first time through the book.

Extending Ruby with C is pretty easy. For instance, suppose we are building a custom Internet-ready jukebox for the Sunset Diner and Grill. It will play MP3 audio files from a hard disk or audio CDs from a CD jukebox. We want to be able to control the jukebox hardware from a Ruby program. The hardware vendor gave us a C header file and a binary library to use; our job is to construct a Ruby object that makes the appropriate C function calls.

Much of the information in this chapter is taken from the `README.EXT` file that is included in the distribution. If you are planning on writing a Ruby extension, you may want to refer to that file for more details as well as the latest changes.

## Your First Extension

Just to introduce extension writing, let's write one. This extension is purely a test of the process—it does nothing that you couldn't do in pure Ruby. We'll also present some stuff without too much explanation—all the messy details will be given later.

The extension we write will have the same functionality as the following Ruby class.

```
class MyTest
 def initialize
 @arr = Array.new
 end
 def add(obj)
 @arr.push(obj)
 end
end
```

That is, we'll be writing an extension in C that is plug-compatible with that Ruby class. The equivalent code in C should look somewhat familiar.

```
#include "ruby.h"
static int id_push;
static VALUE t_init(VALUE self)
{
 VALUE arr;
 arr = rb_ary_new();
 rb_iv_set(self, "@arr", arr);
 return self;
}
static VALUE t_add(VALUE self, VALUE obj)
{
 VALUE arr;
 arr = rb_iv_get(self, "@arr");
 rb_funcall(arr, id_push, 1, obj);
 return arr;
}
VALUE cTest;
void Init_my_test() {
 cTest = rb_define_class("MyTest", rb_cObject);
 rb_define_method(cTest, "initialize", t_init, 0);
 rb_define_method(cTest, "add", t_add, 1);
 id_push = rb_intern("push");
}
```

Let's go through this example in detail, as it illustrates many of the important concepts in this chapter. First, we need to include the header file `ruby.h` to obtain the necessary Ruby definitions.

Now look at the last function, `Init_my_test`. Every extension defines a C global function named `Init_name`. This function will be called when the interpreter first loads the extension *name* (or on startup for statically linked extensions). It is used to initialize the extension and to insinuate it into the Ruby environment. (Exactly how Ruby knows that an extension is called *name* we'll cover later.) In this case, we define a new class named `MyTest`, which is a subclass of `Object` (represented by the external symbol `rb_cObject`; see `ruby.h` for others).

Next we set up `add` and `initialize` as two instance methods for class `MyTest`. The calls to `rb_define_method` establish a binding between the Ruby method name and the C function that will implement it. If Ruby code calls the `add` method on one of our objects, the interpreter will in turn call the C function `t_add` with one argument.

Similarly, when `new` is called for this class, Ruby will construct a basic object and then call `initialize`, which we have defined here to call the C function `t_init` with no (Ruby) arguments.

Now go back and look at the definition of `t_init`. Even though we said it took no arguments, it has a parameter here! In addition to any Ruby arguments, every method is passed an initial VALUE argument that contains the receiver for this method (the equivalent of `self` in Ruby code).

The first thing we'll do in `t_init` is create a Ruby array and set the instance variable `@arr` to point to it. Just as you would expect if you were writing Ruby source, referencing an instance variable that doesn't exist creates it. We then return a pointer to ourselves.

**WARNING:** Every C function that is callable from Ruby *must* return a VALUE, even if it's just `Qnil`. Otherwise, a core dump (or GPF) will be the likely result.

Finally, the function `t_add` gets the instance variable `@arr` from the current object and calls `Array#push` to push the passed value onto that array. When accessing instance variables in this way, the `@` prefix is mandatory—otherwise the variable is created but cannot be referenced from Ruby.

Despite the extra, clunky syntax that C imposes, you're still writing in Ruby—you can manipulate objects using all the method calls you've come to know and love, with the added advantage of being able to craft tight, fast code when needed.

## Building Our Extension

We'll have a lot more to say about building extensions later. For now, though, all we have to do is follow these steps.

1. Create a file called `extconf.rb` in the same directory as our `my_test.c` C source file. The file `extconf.rb` should contain the following two lines.

```
require 'mkmf'
create_makefile("my_test")
```

2. Run `extconf.rb`. This will generate a Makefile.

```
% ruby extconf.rb
creating Makefile
```

3. Use `make` to build the extension. This is what happens on an OS X system.

```
% make
gcc -fno-common -g -O2 -pipe -fno-common -I.
-I/usr/lib/ruby/1.9/powerpc-darwin7.4.0
-I/usr/lib/ruby/1.9/powerpc-darwin7.4.0 -I. -c my_test.c
cc -dynamic -bundle -undefined suppress -flat_namespace
-L'/usr/lib' -o my_test.bundle my_test.o -ldl -lobjc
```

The result of all this is the extension, all nicely bundled up in a shared object (a `.so`, `.dll`, or [on OS X] a `.bundle`).

## Running Our Extension

We can use our extension from Ruby simply by `require`-ing it dynamically at runtime (on most platforms). We can wrap this up in a test to verify that things are working as we expect.

```
require 'my_test'
require 'test/unit'
class TestTest < Test::Unit::TestCase
 def test_test
 t = MyTest.new
 assert_equal(Object, MyTest.superclass)
 assert_equal(MyTest, t.class)
 t.add(1)
 t.add(2)
 assert_equal([1,2], t.instance_eval("@arr"))
 end
end
```

*produces:*

```
Finished in 0.002589 seconds.
1 tests, 3 assertions, 0 failures, 0 errors
```

Once we're happy that our extension works, we can then install it globally by running `make install`.

## Ruby Objects in C

When we wrote our first extension, we cheated, because it didn't really do anything with the Ruby objects—it didn't do calculations based on Ruby numbers, for example. Before we can do this, we need to find out how to represent and access Ruby data types from within C.

Everything in Ruby is an object, and all variables are references to objects. When we're looking at Ruby objects from within C code, the situation is pretty much the same. Most Ruby objects are represented as C pointers to an area in memory that contains the object's data and other implementation details. In C code, all these references are via variables of type `VALUE`, so when you pass Ruby objects around, you'll do it by passing `VALUES`.

This has one exception. For performance reasons, Ruby implements `Fixnums`, `Symbols`, `true`, `false`, and `nil` as so-called *immediate values*. These are still stored in variables of type `VALUE`, but they aren't pointers. Instead, their value is stored directly in the variable.

So sometimes `VALUES` are pointers, and sometimes they're immediate values. How does the interpreter pull off this magic? It relies on the fact that all pointers point to areas of memory aligned on 4- or 8-byte boundaries. This means that it can guarantee that the low 2 bits in a pointer will always be zero. When it wants to store an immediate value, it arranges to have at least one of these bits set, allowing the rest of the interpreter code to distinguish immediate values from pointers. Although this sounds tricky, it's actually easy to use in practice, largely because the interpreter comes with a number of macros and methods that simplify working with the type system.

This is how Ruby implements object-oriented code in C: A Ruby object is an allocated structure in memory that contains a table of instance variables and information about the class. The class itself is another object (an allocated structure in memory) that contains a table of the methods defined for that class. Ruby is built upon this foundation.

## Working With Immediate Objects

As we said above, immediate values are not pointers: `Fixnum`, `Symbol`, `true`, `false`, and `nil` are stored directly in `VALUE`.

`Fixnum` values are stored as 31-bit numbers<sup>1</sup> that are formed by shifting the original number left 1 bit and then setting the LSB, or least significant bit (bit 0), to 1. When `VALUE` is used as a pointer to a specific Ruby structure, it is guaranteed always to have an LSB of zero; the other immediate values also have LSBs of zero. Thus, a simple bit test can tell you whether you have a `Fixnum`. This test is wrapped in a macro, `FIXNUM_P`. Similar tests let you check for other immediate values.

```
FIXNUM_P(value) → nonzero if value is a Fixnum
SYMBOL_P(value) → nonzero if value is a Symbol
NIL_P(value) → nonzero if value is nil
RTEST(value) → nonzero if value is neither nil nor false
```

Several useful conversion macros for numbers as well as other standard data types are shown in Table 21.1 on the following page.

The other immediate values (`true`, `false`, and `nil`) are represented in C as the constants `Qtrue`, `Qfalse`, and `Qnil`, respectively. You can test `VALUE` variables against these constants directly or use the conversion macros (which perform the proper casting).

## Working with Strings

In C, we're used to working with null-terminated strings. Ruby strings, however, are more general and may well include embedded nulls. The safest way to work with

---

1. Or 63-bit on wider CPU architectures.

Table 21.1. C/Ruby data type conversion functions and macros

C Data Types to Ruby Objects:		
	INT2NUM( <i>int</i> )	→ <i>Fixnum</i> or <i>Bignum</i>
	INT2FIX( <i>int</i> )	→ <i>Fixnum</i> (faster)
	LONG2NUM( <i>long</i> )	→ <i>Fixnum</i> or <i>Bignum</i>
	LONG2FIX( <i>int</i> )	→ <i>Fixnum</i> (faster)
	LL2NUM( <i>long long</i> )	→ <i>Fixnum</i> or <i>Bignum</i> (if native system supports <i>long long</i> type)
	ULL2NUM( <i>long long</i> )	→ <i>Fixnum</i> or <i>Bignum</i> (if native system supports <i>long long</i> type)
	CHR2FIX( <i>char</i> )	→ <i>Fixnum</i>
	rb_str_new2( <i>char</i> *)	→ <i>String</i>
	rb_float_new( <i>double</i> )	→ <i>Float</i>
Ruby Objects to C Data Types:		
	int NUM2INT( <i>Numeric</i> )	(Includes type check)
	int FIX2INT( <i>Fixnum</i> )	(Faster)
unsigned int	NUM2UINT( <i>Numeric</i> )	(Includes type check)
unsigned int	FIX2UINT( <i>Fixnum</i> )	(Includes type check)
long	NUM2LONG( <i>Numeric</i> )	(Includes type check)
long	FIX2LONG( <i>Fixnum</i> )	(Faster)
unsigned long	NUM2ULONG( <i>Numeric</i> )	(Includes type check)
char	NUM2CHR( <i>Numeric</i> or <i>String</i> )	(Includes type check)
double	NUM2DBL( <i>Numeric</i> )	
	<i>see text for strings...</i>	

Ruby strings, therefore, is to do what the interpreter does and use both a pointer and a length. In fact, Ruby `String` objects are actually references to an `RString` structure, and the `RString` structure contains both a length and a pointer field. You can access the structure via the `RSTRING` macro.

```
VALUE str;
RSTRING(str)->len → length of the Ruby string
RSTRING(str)->ptr → pointer to string storage
```

1.8

However, life is slightly more complicated than that. Rather than using the `VALUE` object directly when you need a string value, you probably want to call the method `StringValue`, passing it the original value. It'll return an object that you can use `RSTRING` on or throw an exception if it can't derive a string from the original. This is all part of Ruby 1.8's duck typing initiative, described in more detail on pages 280 and 349. The `StringValue` method checks to see if its operand is a `String`. If not, it tries to invoke `to_str` on the object, throwing a `TypeError` exception if it can't.

So, if you want to write some code that iterates over all the characters in a `String` object, you may write:

```
static VALUE iterate_over(VALUE original_str) {
 int i;
 char *p
 VALUE str = StringValue(original_str);
 p = RSTRING(str)->ptr; // may be null
 for (i = 0; i < RSTRING(str)->len; i++, p++) {
 // process *p
 }
 return str;
}
```

If you want to bypass the length, and just access the underlying string pointer, you can use the convenience method `StringValuePtr`, which both resolves the string reference and then returns the C pointer to the contents.

If you plan to use a string to access or control some external resource, you probably want to hook into Ruby’s tainting mechanism. In this case you’ll use the method `SafeStringValue`, which works like `StringValue` but throws an exception if its argument is tainted and the safe level is greater than zero.

## Working with Other Objects

When `VALUES` are not immediate, they are pointers to one of the defined Ruby object structures—you can’t have a `VALUE` that points to an arbitrary area of memory. The structures for the basic built-in classes are defined in `ruby.h` and are named `RClassname`: `RArray`, `RBignum`, `RClass`, `RData`, `RFile`, `RFloat`, `RHash`, `RObject`, `RRegexp`, `RString`, and `RStruct`.

You can check to see what type of structure is used for a particular `VALUE` in a number of ways. The macro `TYPE(obj)` will return a constant representing the C type of the given object: `T_OBJECT`, `T_STRING`, and so on. Constants for the built-in classes are defined in `ruby.h`. Note that the *type* we are referring to here is an implementation detail—it is not the same as the class of an object.

If you want to ensure that a value pointer points to a particular structure, you can use the macro `Check_Type`, which will raise a `TypeError` exception if *value* is not of the expected *type* (which is one of the constants `T_STRING`, `T_FLOAT`, and so on).

```
Check_Type(VALUE value, int type)
```

Again, note that we are talking about “type” as the C structure that represents a particular built-in type. The class of an object is a different beast entirely. The class objects for the built-in classes are stored in C global variables named `rb_cClassname` (for instance, `rb_cObject`); modules are named `rb_mModulename`.

1.8**Pre 1.8 String Access**

Prior to Ruby 1.8, if a `VALUE` was supposed to contain a string, you'd access the `RSTRING` fields directly, and that would be it. In 1.8, however, the gradual introduction of duck typing, along with various optimizations, mean that this approach probably won't work the way you'd like. In particular, the `ptr` field of an `STRING` object might be `null` for zero-length strings. If you use the 1.8 `StringValue` method, it handles this case, resetting null pointers to reference instead a single, shared, empty string.

So, how do you write an extension that will work with both Ruby 1.6 and 1.8? Carefully, and with macros. Perhaps something such as this.

```
#if !defined(StringValue)
define StringValue(x) (x)
#endif
#if !defined(StringValuePtr)
define StringValuePtr(x) ((STR2CSTR(x)))
#end
```

This code defines the 1.8 `StringValue` and `StringValuePtr` macros in terms of the older 1.6 counterparts. If you then write code in terms of these macros, it should compile and run on both older and newer interpreters.

If you want your code to have 1.8 duck-typing behavior, even when running under 1.6, you may want to define `StringValue` slightly differently. The difference between this and the previous implementation is described on page [280](#).

```
#if !defined(StringValue)
define StringValue(x) do {
 if (TYPE(x) != T_STRING) x = rb_str_to_str(x);
 } while (0)
#end
```

It isn't advisable to alter with the data in these C structures directly, however—you may look, but don't touch. Instead, you'll normally use the supplied C functions to manipulate Ruby data (we'll talk more about this in just a moment).

However, in the interests of efficiency you may need to dig into these structures to obtain data. To dereference members of these C structures, you have to cast the generic `VALUE` to the proper structure type. `ruby.h` contains a number of macros that perform the proper casting for you, allowing you to dereference structure members easily. These macros are named `RCLASSNAME`, as in `RSTRING` or `RARRAY`. We've already seen the use of `RSTRING` when working with strings. You can do the same with arrays.



```

VALUE arr;
RARRAY(arr)->len → length of the Ruby array
RARRAY(arr)->capa → capacity of the Ruby array
RARRAY(arr)->ptr → pointer to array storage

```

There are similar accessors for hashes (RHASH), files (RFILE), and so on. Having said all this, you need to be careful about building too much dependence on checking types into your extension code. We have more to say about extensions and the Ruby type system on page 280.

## Global Variables

Most of the time, your extensions will implement classes, and the Ruby code uses those classes. The data you share between the Ruby code and the C code will be wrapped tidily inside objects of the class. This is how it should be.

Sometimes, though, you may need to implement a global variable, accessible by both your C extension and by Ruby code.

The easiest way to do this is to have the variable be a VALUE (that is, a Ruby object). You then bind the address of this C variable to the name of a Ruby variable. In this case, the \$ prefix is optional, but it helps clarify that this is a global variable. And remember: making a stack-based variable a Ruby global is not going to work (for long).

```

static VALUE hardware_list;
static VALUE Init_SysInfo() {
 rb_define_class(...);
 hardware_list = rb_ary_new();
 rb_define_variable("$hardware", &hardware_list);
 ...
 rb_ary_push(hardware_list, rb_str_new2("DVD"));
 rb_ary_push(hardware_list, rb_str_new2("CDPlayer1"));
 rb_ary_push(hardware_list, rb_str_new2("CDPlayer2"));
}

```

The Ruby side can then access the C variable `hardware_list` as `$hardware`.

```
$hardware → ["DVD", "CDPlayer1", "CDPlayer2"]
```

Sometimes, though, life is more complicated. Perhaps you want to define a global variable whose value must be calculated when it is accessed. You do this by defining *hooked* and *virtual* variables. A hooked variable is a real variable that is initialized by a named function when the corresponding Ruby variable is accessed. Virtual variables are similar but are never stored: their value purely comes from evaluating the hook function. See the API section that begins on page 294 for details.

If you create a Ruby object from C and store it in a C global variable *without* exporting it to Ruby, you must at least tell the garbage collector about it, lest ye be reaped inadvertently.

```
static VALUE obj;
// ...
obj = rb_ary_new();
rb_global_variable(obj);
```

## The Jukebox Extension

We’ve covered enough of the basics now to return to our jukebox example—interfacing C code with Ruby and sharing data and behavior between the two worlds.

### Wrapping C Structures

We’ve got the vendor’s library that controls the audio CD jukebox units, and we’re ready to wire it into Ruby. The vendor’s header file looks like this.

```
typedef struct _cdjb {
 int statusf;
 int request;
 void *data;
 char pending;
 int unit_id;
 void *stats;
} CDJukebox;
// Allocate a new CDJukebox structure
CDJukebox *new_jukebox(void);
// Assign the Jukebox to a player
void assign_jukebox(CDJukebox *jb, int unit_id);
// Deallocate when done (and take offline)
void free_jukebox(CDJukebox *jb);
// Seek to a disc, track and notify progress
void jukebox_seek(CDJukebox *jb,
 int disc,
 int track,
 void (*done)(CDJukebox *jb, int percent));
// ... others...
// Report a statistic
double get_avg_seek_time(CDJukebox *jb);
```

This vendor has its act together; while they might not admit it, the code is written with an object-oriented flavor. We don’t know what all those fields mean within the CDJukeBox structure, but that’s OK—we can treat it as an opaque pile of bits. The vendor’s code knows what to do with it; we just have to carry it around.

Anytime you have a C-only structure that you would like to handle as a Ruby object, you should wrap it in a special, internal Ruby class called `DATA` (type `T_DATA`). Two macros do this wrapping, and one macro retrieves your structure back out again.

## API: C Data Type Wrapping

```
VALUE Data_Wrap_Struct(VALUE class, void (*mark)(),
 void (*free)(), void *ptr)
```

Wraps the given C data type *ptr*, registers the two garbage collection routines (see below), and returns a VALUE pointer to a genuine Ruby object. The C type of the resulting object is `T_DATA`, and its Ruby class is *class*.

```
VALUE Data_Make_Struct(VALUE class, c-type, void (*mark)(),
 void (*free)(), c-type *)
```

Allocates and sets to zero a structure of the indicated type first and then proceeds as `Data_Wrap_Struct`. *c-type* is the name of the C data type that you're wrapping, not a variable of that type.

```
Data_Get_Struct(VALUE obj, c-type, c-type *)
```

Returns the original pointer. This macro is a type-safe wrapper around the macro `DATA_PTR(obj)`, which evaluates the pointer.

The object created by `Data_Wrap_Struct` is a normal Ruby object, except that it has an additional C data type that can't be accessed from Ruby. As you can see in [Figure 21.1](#) on the following page, this C data type is separate from any instance variables that the object contains. But since it's a separate thing, how do you get rid of it when the garbage collector claims this object? What if you have to release some resource (close some file, clean up some lock or IPC mechanism, and so on)?

Ruby uses a mark and sweep garbage collection scheme. During the mark phase, Ruby looks for pointers to areas of memory. It marks these areas as “in use” (because something is pointing to them). If those areas themselves contain more pointers, the memory these pointers reference is also marked, and so on. At the end of the mark phase, all memory that is referenced will have been marked, and any orphaned areas will not have a mark. At this point the sweep phase starts, freeing off memory that isn't marked.

To participate in Ruby's mark-and-sweep garbage collection process, you must define a routine to free your structure and possibly a routine to mark any references from your structure to other structures. Both routines take a void pointer, a reference to your structure. The *mark* routine will be called by the garbage collector during its “mark” phase. If your structure references other Ruby objects, then your mark function needs to identify these objects using `rb_gc_mark(value)`. If the structure doesn't reference other Ruby objects, you can simply pass 0 as a function pointer.

Figure 21.1. Wrapping objects around C data types

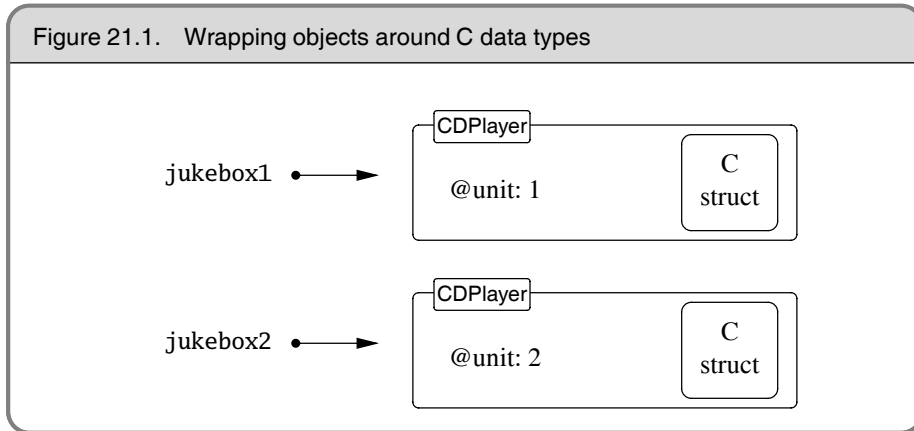

When the object needs to be disposed of, the garbage collector will call the *free* routine to free it. If you have allocated any memory yourself (for instance, by using `Data_Make_Struct`), you'll need to pass a free function—even if it's just the standard C library's free routine. For complex structures that you have allocated, your free function may need to traverse the structure to free all the allocated memory.

Let's look at our CD player interface. The vendor library passes the information around between its various functions in a `CDJukebox` structure. This structure represents the state of the jukebox and therefore is a good candidate for wrapping within our Ruby class. You create new instances of this structure by calling the library's `CDPlayerNew` method. You'd then want to wrap that created structure inside a new `CDPlayer` Ruby object. A fragment of code to do this may look like the following. (We'll talk about that magic *klass* parameter in a minute.)

```
CDJukebox *jukebox;
VALUE obj;
// Vendor library creates the Jukebox
jukebox = new_jukebox();
// then we wrap it inside a Ruby CDPlayer object
obj = Data_Wrap_Struct(klass, 0, cd_free, jukebox);
```

Once this code had executed, *obj* would hold a reference to a newly allocated `CDPlayer` Ruby object, wrapping a new `CDJukebox` C structure. Of course, to get this code to compile, we'd need to do some more work. We'd have to define the `CDPlayer` class and store a reference to it in the variable `cCDPlayer`. We'd also have to define the function to free off our object, `cdplayer_free`. That's easy: it just calls the vendor library dispose method.

```
static void cd_free(void *p) {
 free_jukebox(p);
}
```

However, code fragments do not a program make. We need to package all this stuff in a way that integrates it into the interpreter. And to do that, we need to look at some of the conventions the interpreter uses.

## Object Creation

1.8 Ruby 1.8 has rationalized the creation and initialization of objects. Although the old ways still work, the new way, using allocation functions, is much tidier (and is less likely to be deprecated in the future).

The basic idea is simple. Let's say you're creating an object of class `CDPlayer` in your Ruby program.

```
cd = CDPlayer.new
```

Underneath the covers, the interpreter calls the class method `new` for `CDPlayer`. As `CDPlayer` hasn't defined a method `new`, Ruby looks into its parent, class `Class`.

The implementation of `new` in class `Class` is fairly simple: it allocates memory for the new object and then calls the object's `initialize` method to initialize that memory.

So, if our `CDPlayer` extension is to be a good Ruby citizen, it should work within this framework. This means that we'll need to implement an allocation function and an `initialize` method.

## Allocation Functions

The allocation function is responsible for creating the memory used by your object. If the object you're implementing doesn't use any data other than Ruby instance variables, then you don't need to write an allocation function—Ruby's default allocator will work just fine. But if your class wraps a C structure, you'll need to allocate space for that structure in the allocation function. The allocation function gets passed the class of the object being allocated. In our case it will in all likelihood be a `cCDPlayer`, but we'll use the parameter as given, as this means that we'll work correctly if subclassed.

```
static VALUE cd_alloc(VALUE klass) {
 CDJukebox *jukebox;
 VALUE obj;
 // Vendor library creates the Jukebox
 jukebox = new_jukebox();
 // then we wrap it inside a Ruby CDPlayer object
 obj = Data_Wrap_Struct(klass, 0, cd_free, jukebox);
 return obj;
}
```

You then need to register your allocation function in your class's initialization code.

```

void Init_CDPlayer() {
 cCDPlayer = rb_define_class("CDPlayer", rb_cObject);
 rb_define_alloc_func(cCDPlayer, cd_alloc);
 // ...
}

```

Most objects probably need to define an initializer too. The allocation function creates an empty, uninitialized object, and we'll need to fill in specific values. In the case of the CD player, the constructor is called with the unit number of the player to be associated with this object.

```

static VALUE cd_initialize(VALUE self, VALUE unit) {
 int unit_id;
 CDJukebox *jb;
 Data_Get_Struct(self, CDJukebox, jb);
 unit_id = NUM2INT(unit);
 assign_jukebox(jb, unit_id);
 return self;
}

```

One of the reasons for this multistep object creation protocol is that it lets the interpreter handle situations where objects have to be created by “back-door means.” One example is when objects are being deserialized from their marshaled form. Here, the interpreter needs to create an empty object (by calling the allocator), but it cannot call the initializer (as it has no knowledge of the parameters to use). Another common situation is when objects are duplicated or cloned.

One further issue lurks here. Because users can choose to bypass either the constructor, you need to ensure that your allocation code leaves the returned object in a valid state. It may not contain all the information it would have had, had it been set up by `#initialize`, but it at least needs to be usable.

## Cloning Objects

All Ruby objects can be copied using one of two methods, `dup` and `clone`. The two methods are similar: Both produce a new instance of their receiver's class by calling the allocation function. Then they copy across any instance variables from the original. `clone` then goes a bit further and copies the original's singleton class (if it has one) and flags (such as the flag that indicates that an object is frozen). You can think of `dup` as being a copy of the contents and `clone` as being a copy of the full object.

However, the Ruby interpreter doesn't know how to handle copying the internal state of objects that you write as C extensions. For example, if your object wraps a C structure that contains an open file descriptor, it's up to the semantics of your implementation whether that descriptor should simply be copied to the new object or whether a new file descriptor should be opened.

1.8**Pre-1.8 Object Allocation**

Prior to Ruby 1.8, if you wanted to allocate additional space in an object, either you had to put that code in the `initialize` method, or you had to define a new method for your class. Guy Decoux recommends the following hybrid approach for maximizing compatibility between 1.6 and 1.8 extensions.

```
static VALUE cd_alloc(VALUE klass) {
 // same as before
}

static VALUE cd_new(int argc, VALUE *argv, VALUE klass) {
 VALUE obj = rb_funcall2(klass,
 rb_intern("allocate"), 0, 0);
 rb_obj_call_init(obj, argc, argv);
 return obj;
}

void init_CDPlayer() {
 // ...

#ifdef HAVE_RB_DEFINE_ALLOC_FUNC
 // 1.8 allocation
 rb_define_alloc_func(cDPlayer, cd_alloc);
#else
 // define manual allocation function for 1.6
 rb_define_singleton_method(cDPlayer, "allocate",
 cd_alloc, 0);
#endif
 rb_define_singleton_method(cDPlayer, "new", cd_new, -1);
 // ...
}
```

If you're writing code that should run on both recent and old versions of Ruby, you'll need to take an approach similar to this. However, you'll probably also need to handle cloning and duplication, and you'll need to consider what happens when your object gets marshaled.

To handle this, the interpreter delegates to your code the responsibility of copying the internal state of objects that you implement. After copying the object's instance variables, the interpreter invokes the new object's `initialize_copy` method, passing in a reference to the original object. It's up to you to implement meaningful semantics in this method.

For our `CDPlayer` class we'll take a fairly simple approach to the cloning issue: we'll simply copy across the `CDJukebox` structure from the original object.

There's a wee chunk of strange code in this example. To test that the original object is indeed something we can clone the new one from, the code checks to see that the original

1. has a TYPE of T\_DATA (which means that it's a noncore object), and
2. has a free function with the same address as our free function.

This is a relatively high-performance way of verifying that the original object is compatible with our own (as long as you don't share free functions between classes). An alternative, which is slower, would be to use `rb_obj_is_kind_of` and do a direct test on the class.

```
static VALUE cd_init_copy(VALUE copy, VALUE orig) {
 CDJukebox *orig_jb;
 CDJukebox *copy_jb;
 if (copy == orig)
 return copy;
 // we can initialize the copy from other CDPlayers
 // or their subclasses only
 if (TYPE(orig) != T_DATA ||
 RDATA(orig)->dfree != (RUBY_DATA_FUNC)cd_free) {
 rb_raise(rb_eTypeError, "wrong argument type");
 }
 // copy all the fields from the original
 // object's CDJukebox structure to the
 // new object
 Data_Get_Struct(orig, CDJukebox, orig_jb);
 Data_Get_Struct(copy, CDJukebox, copy_jb);
 MEMCPY(copy_jb, orig_jb, CDJukebox, 1);
 return copy;
}
```

Our copy method does not have to allocate a wrapped structure to receive the original objects CDJukebox structure: the `cd_alloc` method has already taken care of that.

Note that in this case it's correct to do type checking based on classes: we need the original object to have a wrapped CDJukebox structure, and the only objects that have one of these are derived from class CDPlayer.

## Putting It All Together

OK, finally we're ready to write all the code for our CDPlayer class.

```
#include "ruby.h"
#include "cdjukebox.h"
static VALUE cCDPlayer;
```



```

// Helper function to free a vendor CDJukebox
static void cd_free(void *p) {
 free_jukebox(p);
}
// Allocate a new CDPlayer object, wrapping
// the vendor's CDJukebox structure
static VALUE cd_alloc(VALUE klass) {
 CDJukebox *jukebox;
 VALUE obj;
 // Vendor library creates the Jukebox
 jukebox = new_jukebox();
 // then we wrap it inside a Ruby CDPlayer object
 obj = Data_Wrap_Struct(klass, 0, cd_free, jukebox);
 return obj;
}
// Assign the newly created CDPlayer to a
// particular unit
static VALUE cd_initialize(VALUE self, VALUE unit) {
 int unit_id;
 CDJukebox *jb;
 Data_Get_Struct(self, CDJukebox, jb);
 unit_id = NUM2INT(unit);
 assign_jukebox(jb, unit_id);
 return self;
}
// Copy across state (used by clone and dup). For jukeboxes, we
// actually create a new vendor object and set its unit number from
// the old
static VALUE cd_init_copy(VALUE copy, VALUE orig) {
 CDJukebox *orig_jb;
 CDJukebox *copy_jb;
 if (copy == orig)
 return copy;
 // we can initialize the copy from other CDPlayers or their
 // subclasses only
 if (TYPE(orig) != T_DATA ||
 RDATA(orig)->dfree != (RUBY_DATA_FUNC)cd_free) {
 rb_raise(rb_eTypeError, "wrong argument type");
 }
 // copy all the fields from the original object's CDJukebox
 // structure to the new object
 Data_Get_Struct(orig, CDJukebox, orig_jb);
 Data_Get_Struct(copy, CDJukebox, copy_jb);
 MEMCPY(copy_jb, orig_jb, CDJukebox, 1);
 return copy;
}

```

```

// The progress callback yields to the caller the percent complete
static void progress(CDJukebox *rec, int percent) {
 if (rb_block_given_p()) {
 if (percent > 100) percent = 100;
 if (percent < 0) percent = 0;
 rb_yield(INT2FIX(percent));
 }
}

// Seek to a given part of the track, invoking the progress callback
// as we go
static VALUE
cd_seek(VALUE self, VALUE disc, VALUE track) {
 CDJukebox *jb;
 Data_Get_Struct(self, CDJukebox, jb);
 jukebox_seek(jb,
 NUM2INT(disc),
 NUM2INT(track),
 progress);
 return Qnil;
}

// Return the average seek time for this unit
static VALUE
cd_seek_time(VALUE self)
{
 double tm;
 CDJukebox *jb;
 Data_Get_Struct(self, CDJukebox, jb);
 tm = get_avg_seek_time(jb);
 return rb_float_new(tm);
}

// Return this player's unit number
static VALUE
cd_unit(VALUE self) {
 CDJukebox *jb;
 Data_Get_Struct(self, CDJukebox, jb);
 return INT2NUM(jb->unit_id);
}

void Init_CDPlayer() {
 cCDPlayer = rb_define_class("CDPlayer", rb_cObject);
 rb_define_alloc_func(cCDPlayer, cd_alloc);
 rb_define_method(cCDPlayer, "initialize", cd_initialize, 1);
 rb_define_method(cCDPlayer, "initialize_copy", cd_init_copy, 1);
 rb_define_method(cCDPlayer, "seek", cd_seek, 2);
 rb_define_method(cCDPlayer, "seek_time", cd_seek_time, 0);
 rb_define_method(cCDPlayer, "unit", cd_unit, 0);
}

```

Now we can control our jukebox from Ruby in a nice, object-oriented way.

```
require 'CDPlayer'
p = CDPlayer.new(13)
puts "Unit is #{p.unit}"
p.seek(3, 16) {|x| puts "#{x}% done" }
puts "Avg. time was #{p.seek_time} seconds"
p1 = p.dup
puts "Cloned unit = #{p1.unit}"
```

*produces:*

```
Unit is 13
26% done
79% done
100% done
Avg. time was 1.2 seconds
Cloned unit = 13
```

This example demonstrates most of what we've talked about so far, with one additional neat feature. The vendor's library provided a callback routine—a function pointer that is called every so often while the hardware is grinding its way to the next disc. We've set that up here to run a code block passed as an argument to `seek`. In the `progress` function, we check to see if there is an iterator in the current context and, if there is, run it with the current percent done as an argument.

## Memory Allocation

You may sometimes need to allocate memory in an extension that won't be used for object storage—perhaps you've got a giant bitmap for a Bloom filter, an image, or a whole bunch of little structures that Ruby doesn't use directly.

To work correctly with the garbage collector, you should use the following memory allocation routines. These routines do a little bit more work than the standard `malloc`. For instance, if `ALLOC_N` determines that it cannot allocate the desired amount of memory, it will invoke the garbage collector to try to reclaim some space. It will raise a `NoMemError` if it can't or if the requested amount of memory is invalid.

### API: Memory Allocation

*type* \* **ALLOC\_N**( *c-type*, *n* )

Allocates *n* *c-type* objects, where *c-type* is the literal name of the C type, not a variable of that type.

*type* \* **ALLOC**( *c-type* )

Allocates a *c-type* and casts the result to a pointer of that type.

**REALLOC\_N**( *var*, *c-type*, *n* )

Reallocates *n c-types* and assigns the result to *var*, a pointer to a variable of type *c-type*.

*type* \* **ALLOCA\_N**( *c-type*, *n* )

Allocates memory for *n* objects of *c-type* on the stack—this memory will be automatically freed when the function that invokes **ALLOCA\_N** returns.

## Ruby Type System

### 1.8

In Ruby, we rely less on the type (or class) on an object and more on its capabilities. This is called *duck typing*. We describe it in more detail in Chapter 23 on page 349. You'll find many examples of this if you examine the source code for the interpreter itself. For example, the following code implements the `Kernel.exec` method.

```

VALUE
rb_f_exec(argc, argv)
 int argc;
 VALUE *argv;
{
 VALUE prog = 0;
 VALUE tmp;
 if (argc == 0) {
 rb_raise(rb_eArgError, "wrong number of arguments");
 }
 tmp = rb_check_array_type(argv[0]);
 if (!NIL_P(tmp)) {
 if (RARRAY(tmp)->len != 2) {
 rb_raise(rb_eArgError, "wrong first argument");
 }
 prog = RARRAY(tmp)->ptr[0];
 SafeStringValue(prog);
 argv[0] = RARRAY(tmp)->ptr[1];
 }
 if (argc == 1 && prog == 0) {
 VALUE cmd = argv[0];
 SafeStringValue(cmd);
 rb_proc_exec(RSTRING(cmd)->ptr);
 }
 else {
 proc_exec_n(argc, argv, prog);
 }
 rb_sys_fail(RSTRING(argv[0])->ptr);
 return Qnil; /* dummy */
}

```

The first parameter to this method may be a string or an array containing two strings. However, the code doesn't explicitly check the type of the argument. Instead, it first calls `rb_check_array_type`, passing in the argument. What does this method do? Let's see.

```
VALUE
rb_check_array_type(ary)
 VALUE ary;
{
 return rb_check_convert_type(ary, T_ARRAY, "Array", "to_ary");
}
```

The plot thickens. Let's track down `rb_check_convert_type`.

```
VALUE
rb_check_convert_type(val, type, tname, method)
 VALUE val;
 int type;
 const char *tname, *method;
{
 VALUE v;
 /* always convert T_DATA */
 if (TYPE(val) == type && type != T_DATA) return val;
 v = convert_type(val, tname, method, Qfalse);
 if (NIL_P(v)) return Qnil;
 if (TYPE(v) != type) {
 rb_raise(rb_eTypeError, "%s#%s should return %s",
 rb_obj_classname(val), method, tname);
 }
 return v;
}
```

Now we're getting somewhere. If the object is the correct type (`T_ARRAY` in our example), then the original object is returned. Otherwise, we don't give up quite yet. Instead we call our original object and ask if it can represent itself as an array (we call its `to_ary` method). If it can, we're happy and continue. The code is saying "I don't need an Array, I just need something that can be represented as an array." This means that `Kernel.exec` will accept as an array any parameter that implements a `to_ary` method. We discuss these conversion protocols in more detail (but from the Ruby perspective) starting on page [355](#).

What does all this mean to you as an extension writer? There are two messages. First, try to avoid checking the types of parameters passed to you. Instead, see if there's a `rb_check_xxx_type` method that will convert the parameter into the type that you need. If not, look for an existing conversion function (such as `rb_Array`, `rb_Float`, or `rb_Integer`) that'll do the trick for you. Second, if you're writing an extension that implements something that may be meaningfully used as a Ruby string or array, consider implementing `to_str` or `to_ary` methods, allowing objects implemented by your extension to be used in string or array contexts.

## Creating an Extension

Having written the source code for an extension, we now need to compile it so Ruby can use it. We can either do this as a shared object, which is dynamically loaded at runtime, or statically link the extension into the main Ruby interpreter itself. The basic procedure is the same.

1. Create the C source code file(s) in a given directory.
2. Optionally create an supporting Ruby files in a `lib` subdirectory.
3. Create `extconf.rb`.
4. Run `extconf.rb` to create a `Makefile` for the C files in this directory.
5. Run `make`.
6. Run `make install`.

### Creating a Makefile with `extconf.rb`

Figure 21.2 on the next page shows the overall workflow when building an extension. The key to the whole process is the `extconf.rb` program that you, as a developer, create. In `extconf.rb`, you write a simple program that determines what features are available on the user's system and where those features may be located. Executing `extconf.rb` builds a customized `Makefile`, tailored for both your application and the system on which it's being compiled. When you run the `make` command against this `Makefile`, your extension is built and (optionally) installed.

The simplest `extconf.rb` may be just two lines long, and for many extensions this is sufficient.

```
require 'mkmf'
create_makefile("Test")
```

The first line brings in the `mkmf` library module (described starting on page 755). This contains all the commands we'll be using. The second line creates a `Makefile` for an extension called "Test." (Note that "Test" is the name of the extension; the `makefile` will always be called `Makefile`.) `Test` will be built from all the C source files in the current directory. When your code is loaded, Ruby will call its `Init_Test` method.

Let's say that we run this `extconf.rb` program in a directory containing a single source file, `main.c`. The result is a `makefile` that will build our extension. On a Linux box, this executes the following commands.

```
gcc -fPIC -I/usr/local/lib/ruby/1.8/i686-linux -g -O2 \
-c main.c -o main.o
gcc -shared -o Test.so main.o -lc
```

The result of this compilation is `Test.so`, which may be dynamically linked into Ruby at runtime with `require`.

Figure 21.2. Building an extension

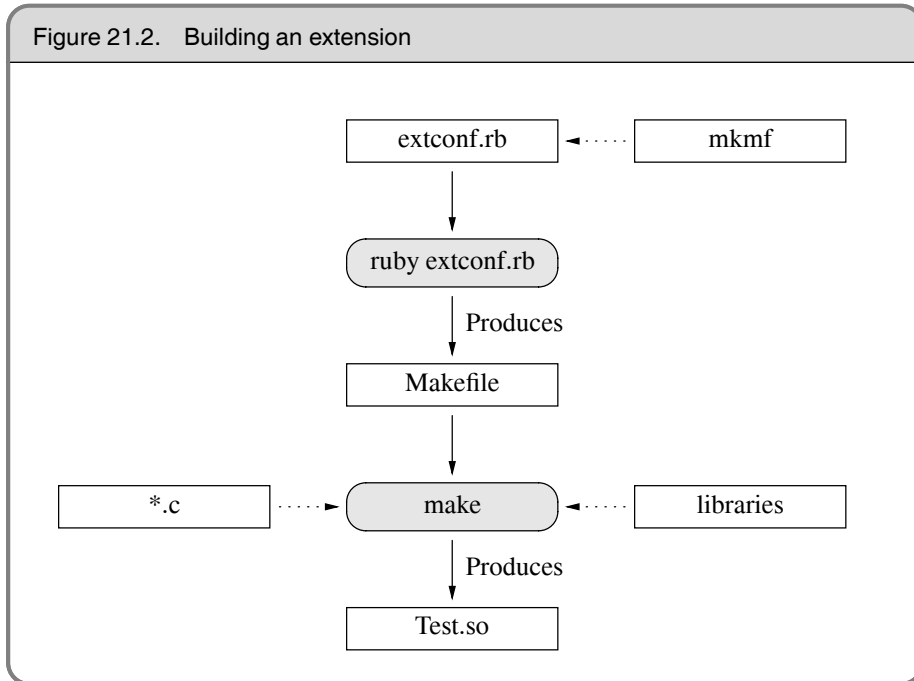

Under Mac OS X, the commands are different, but the result is the same: a shared object (a *bundle* on the Mac) is created.

```

gcc -fno-common -g -O2 -pipe -fno-common \
 -I/usr/lib/ruby/1.8/powerpc-darwin \
 -I/usr/lib/ruby/1.8/powerpc-darwin -c main.c
cc -dynamic -bundle -undefined suppress -flat_namespace \
 -L'/usr/lib' -o Test.bundle main.o -ldl -lobjc

```

See how the `mkmf` commands have automatically located platform-specific libraries and used options specific to the local compiler. Pretty neat, eh?

Although this basic `extconf.rb` program works for many simple extensions, you may have to do some more work if your extension needs header files or libraries that aren't included in the default compilation environment or if you conditionally compile code based on the presence of libraries or functions.

A common requirement is to specify nonstandard directories where include files and libraries may be found. This is a two-step process. First, your `extconf.rb` should contain one or more `dir_config` commands. This specifies a tag for a set of directories. Then, when you run the `extconf.rb` program, you tell `mkmf` where the corresponding physical directories are on the current system.

### Dividing Up the Namespace

Increasingly, extension writers are being good citizens. Rather than install their work directory into one of Ruby's library directories, they're using subdirectories to group their files together. This is easy with `extconf.rb`. If the parameter to the `create_makefile` call contains forward slashes, `mkmf` assumes that everything before the last slash is a directory name and that the remainder is the extension name. The extension will be installed into the given directory (relative to the Ruby directory tree). In the following example, the extension will still be named `Test`.

```
require 'mkmf'
create_makefile("wibble/Test")
```

However, when you require this class in a Ruby program, you'd write

```
require 'wibble/Test'
```

If `extconf.rb` contains the line `dir_config(name)`, then you give the location of the corresponding directories with the command-line options

**--with-name-include=directory**

Add *directory/include* to the compile command.

**--with-name-lib=directory**

Add *directory/lib* to the link command.

If (as is common) your include and library directories are subdirectories called `include` and `lib` of some other directory, you can take a shortcut.

**--with-name-dir=directory**

Add *directory/lib* and *directory/include* to the link command and compile command, respectively.

As well as specifying all these `--with` options when you run `extconf.rb`, you can also use the `--with` options that were specified when Ruby was built for your machine. This means you can discover and use the locations of libraries that are used by Ruby itself.

To make all this concrete, let's say you need to use the vendor's CDJukebox libraries and include files for the CD player we're developing. Your `extconf.rb` may contain

```
require 'mkmf'
dir_config('cdjukebox')
.. more stuff
create_makefile("CDPlayer")
```



You'd then run `extconf.rb` with something like

```
% ruby extconf.rb --with-cdjukebox-dir=/usr/local/cdjb
```

The generated Makefile would assume that `/usr/local/cdjb/lib` contained the libraries and `/usr/local/cdjb/include` the include files.

The `dir_config` command adds to the list of places to search for libraries and include files. It does not, however, link the libraries into your application. To do that, you'll need to use one or more `have_library` or `find_library` commands.

`have_library` looks for a given entry point in a named library. If it finds the entry point, it adds the library to the list of libraries to be used when linking your extension. `find_library` is similar but allows you to specify a list of directories to search for the library. Here are the contents of the `extconf.rb` that we use to link our CD player.

```
require 'mkmf'
dir_config("cdjukebox")
have_library("cdjukebox", "new_jukebox")
create_makefile("CDPlayer")
```

A particular library may be in different places depending on the host system. The X Window system, for example, is notorious for living in different directories on different systems. The `find_library` command will search a list of supplied directories to find the right one (this is different from `have_library`, which uses only configuration information for the search). For example, to create a Makefile that uses X Windows and a JPEG library, `extconf.rb` may contain

```
require 'mkmf'
if have_library("jpeg", "jpeg_mem_init") and
 find_library("X11", "XOpenDisplay",
 "/usr/X11/lib", # list of directories
 "/usr/X11R6/lib", # to check
 "/usr/openwin/lib") # for library
 then
 create_makefile("XThing")
 else
 puts "No X/JPEG support available"
 end
```

We've added some additional functionality to this program. All the `mkmf` commands return `false` if they fail. This means we can write an `extconf.rb` that generates a Makefile only if everything it needs is present. The Ruby distribution does this so that it will try to compile only those extensions that are supported on your system.

You also may want your extension code to be able to configure the features it uses depending on the target environment. For example, our CD jukebox may be able to use a high-performance MP3 decoder if the end user has one installed. We can check by looking for its header file.

```
require 'mkmf'
dir_config('cdjukebox')
have_library('cdjb', 'CDPlayerNew')
have_header('hp_mp3.h')
create_makefile("CDJukeBox")
```

We can also check to see if the target environment has a particular function in any of the libraries we'll be using. For example, the `setpriority` call would be useful but isn't always available. We can check for it with

```
require 'mkmf'
dir_config('cdjukebox')
have_func('setpriority')
create_makefile("CDJukeBox")
```

Both `have_header` and `have_func` define preprocessor constants if they find their targets. The names are formed by converting the target name to uppercase and prepending `HAVE_`. Your C code can take advantage of this using constructs such as

```
#if defined(HAVE_HP_MP3_H)
include <hp_mp3.h>
#endif
#if defined(HAVE_SETPRIORITY)
err = setpriority(PRIOR_PROCESS, 0, -10)
#endif
```

If you have special requirements that can't be met with all these `mkmf` commands, your program can directly add to the global variables `$CFLAGS` and `$LFLAGS`, which are passed to the compiler and linker, respectively.

Sometimes you'll create an `extconf.rb`, and it just doesn't seem to work. You give it the name of a library, and it swears that no such library has ever existed on the entire planet. You tweak and tweak, but `mkmf` still can't find the library you need. It would be nice if you could find out exactly what it's doing behind the scenes. Well, you can. Each time you run your `extconf.rb` script, `mkmf` generates a log file containing details of what it did. If you look in `mkmf.log`, you'll be able to see what steps the program used to try to find the libraries you requested. Sometimes trying these steps manually will help you track down the problem.

## Installation Target

The Makefile produced by your `extconf.rb` will include an “install” target. This will copy your shared library object into the correct place on your (or your users') local file system. The destination is tied to the installation location of the Ruby interpreter you used to run `extconf.rb` in the first place. If you have multiple Ruby interpreters installed on your box, your extension will be installed into the directory tree of the one that ran `extconf.rb`.

In addition to installing the shared library, `extconf.rb` will check for the presence of a `lib/` subdirectory. If it finds one, it will arrange for any Ruby files there to be installed along with your shared object. This is useful if you want to split the work of writing your extension between low-level C code and higher-level Ruby code.

## Static Linking

Finally, if your system doesn't support dynamic linking, or if you have an extension module that you want to have statically linked into Ruby itself, edit the file `ext/Setup` in the distribution and add your directory to the list of extensions in the file. In your extension's directory, create a file named `MANIFEST` containing a list of all the files in your extension (source, `extconf.rb`, `lib/`, and so on). Then rebuild Ruby. The extensions listed in `Setup` will be statically linked into the Ruby executable. If you want to disable any dynamic linking, and link all extensions statically, edit `ext/Setup` to contain the following option.

```
option nodynamic
```

## A Shortcut

If you are extending an existing library written in C or C++, you may want to investigate SWIG (<http://www.swig.org>). SWIG is an interface generator: it takes a library definition (typically from a header file) and automatically generates the glue code needed to access that library from another language. SWIG supports Ruby, meaning that it can generate the C source files that wrap external libraries in Ruby classes.

## Embedding a Ruby Interpreter

In addition to extending Ruby by adding C code, you can also turn the problem around and embed Ruby itself within your application. You have two ways to do this. The first is to let the interpreter take control by calling `ruby_run`. This is the easiest approach, but it has one significant drawback—the interpreter never returns from a `ruby_run` call. Here's an example.

```
#include "ruby.h"
int main(void) {
 /* ... our own application stuff ... */
 ruby_init();
 ruby_init_loadpath();
 ruby_script("embedded");
 rb_load_file("start.rb");
 ruby_run();
 exit(0);
}
```

To initialize the Ruby interpreter, you need to call `ruby_init()`. But on some platforms, you may need to take special steps before that.

```
#if defined(NT)
 NtInitialize(&argc, &argv);
#endif
#if defined(__MACOS__) && defined(__MWERKS__)
 argc = ccommand(&argv);
#endif
```

See `main.c` in the Ruby distribution for any other special defines or setup needed for your platform.

You need the Ruby include and library files accessible to compile this embedded code. On my box (Mac OS X) I have the Ruby 1.8 interpreter installed in a private directory, so my Makefile looks like this.

```
WHERE=/Users/dave/ruby1.8/lib/ruby/1.8/powerpc-darwin/
CFLAGS=-I$(WHERE) -g
LDFLAGS=-L$(WHERE) -lruby -ldl -lobjc
embed: embed.o
 $(CC) -o embed embed.o $(LDFLAGS)
```

The second way of embedding Ruby allows Ruby code and your C code to engage in more of a dialogue: the C code calls some Ruby code, and the Ruby code responds. You do this by initializing the interpreter as normal. Then, rather than entering the interpreter's main loop, you instead invoke specific methods in your Ruby code. When these methods return, your C code gets control back.

There's a wrinkle, though. If the Ruby code raises an exception and it isn't caught, your C program will terminate. To overcome this, you need to do what the interpreter does and protect all calls that could raise an exception. This can get messy. The `rb_protect` method call wraps the call to another C function. That second function should invoke our Ruby method. However, the method wrapped by `rb_protect` is defined to take just a single parameter. To pass more involves some ugly C casting.

Let's look at an example. Here's a simple Ruby class that implements a method to return the sum of the numbers from one to *max*.

```
class Summer
 def sum(max)
 raise "Invalid maximum #{max}" if max < 0
 (max*max + max)/2
 end
end
```

Let's write a C program that calls an instance of this class multiple times. To create the instance, we'll get the class object (by looking for a top-level constant whose name is the name of our class). We'll then ask Ruby to create an instance of that class—`rb_class_new_instance` is actually a call to `Class.new`. (The two initial 0 param-

ters are the argument count and a dummy pointer to the arguments themselves.) Once we have that object, we can invoke its `sum` method using `rb_funcall`.

```
#include "ruby.h"
static int id_sum;
int Values[] = { 5, 10, 15, -1, 20, 0 };
static VALUE wrap_sum(VALUE args) {
 VALUE *values = (VALUE *)args;
 VALUE summer = values[0];
 VALUE max = values[1];
 return rb_funcall(summer, id_sum, 1, max);
}
static VALUE protected_sum(VALUE summer, VALUE max) {
 int error;
 VALUE args[2];
 VALUE result;

 args[0] = summer;
 args[1] = max;
 result = rb_protect(wrap_sum, (VALUE)args, &error);
 return error ? Qnil : result;
}

int main(void) {
 int value;
 int *next = Values;
 ruby_init();
 ruby_init_loadpath();
 ruby_script("embedded");
 rb_require("sum.rb");
 // get an instance of Summer
 VALUE summer = rb_class_new_instance(0, 0,
 rb_const_get(rb_cObject, rb_intern("Summer")));
 id_sum = rb_intern("sum");
 while (value = *next++) {
 VALUE result = protected_sum(summer, INT2NUM(value));
 if (NIL_P(result))
 printf("Sum to %d doesn't compute!\n", value);
 else
 printf("Sum to %d is %d\n", value, NUM2INT(result));
 }
 ruby_finalize();
 exit(0);
}
```

One last thing: the Ruby interpreter was not originally written with embedding in mind. Probably the biggest problem is that it maintains state in global variables, so it isn't thread-safe. You can embed Ruby—just one interpreter per process.

A good resource for embedding Ruby in C++ programs is at <http://metaeditor.sourceforge.net/embed/>. This page also contains links to other examples of embedding Ruby.

## API: Embedded Ruby API

```
void ruby_init()
 Sets up and initializes the interpreter. This function should be called
 before any other Ruby-related functions.
```

```
void ruby_init_loadpath()
 Initializes the $: (load path) variable; necessary if your code loads
 any library modules.
```

```
void ruby_options(int argc, char **argv)
 Gives the Ruby interpreter the command-line options.
```

```
void ruby_script(char *name)
 Sets the name of the Ruby script (and $0) to name.
```

```
void rb_load_file(char *file)
 Loads the given file into the interpreter.
```

```
void ruby_run()
 Runs the interpreter.
```

```
void ruby_finalize()
 Shuts down the interpreter.
```

For another example of embedding a Ruby interpreter within another program, see also `eruby`, which is described beginning on page 229.

## Bridging Ruby to Other Languages

So far, we've discussed extending Ruby by adding routines written in C. However, you can write extensions in just about any language, as long as you can bridge the two languages with C. Almost anything is possible, including awkward marriages of Ruby and C++, Ruby and Java, and so on.

But you may be able to accomplish the same thing without resorting to C code. For example, you could bridge to other languages using middleware such as SOAP or COM. See the section on SOAP (page 236) and the section on Windows Automation beginning on page 255 for more details.

# Ruby C Language API

Last, but by no means least, here are some C-level functions that you may find useful when writing an extension.

Some functions require an ID: you can obtain an ID for a string by using `rb_intern` and reconstruct the name from an ID by using `rb_id2name`.

As most of these C functions have Ruby equivalents that are already described in detail elsewhere in this book, the descriptions here will be brief.

The following listing is not complete. Many more functions are available—too many to document them all, as it turns out. If you need a method that you can't find here, check `ruby.h` or `intern.h` for likely candidates. Also, at or near the bottom of each source file is a set of method definitions that describes the binding from Ruby methods to C functions. You may be able to call the C function directly or search for a wrapper function that calls the function you need. The following list, based on the list in `README.EXT`, shows the main source files in the interpreter.

## Ruby Language Core

`class.c`, `error.c`, `eval.c`, `gc.c`, `object.c`, `parse.y`, `variable.c`

## Utility Functions

`dln.c`, `regex.c`, `st.c`, `util.c`

## Ruby Interpreter

`dmymext.c`, `inits.c`, `keywords` `main.c`, `ruby.c`, `version.c`

## Base Library

`array.c`, `bignum.c`, `compar.c`, `dir.c`, `enum.c`, `file.c`, `hash.c`, `io.c`, `marshal.c`, `math.c`, `numeric.c`, `pack.c`, `prec.c`, `process.c`, `random.c`, `range.c`, `re.c`, `signal.c`, `sprintf.c`, `string.c`, `struct.c`, `time.c`

## API: Defining Classes

VALUE **rb\_define\_class**( char \*name, VALUE superclass )  
 Defines a new class at the top level with the given *name* and *superclass* (for class Object, use `rb_cObject`).

VALUE **rb\_define\_module**( char \*name )  
 Defines a new module at the top level with the given *name*.

VALUE **rb\_define\_class\_under**( VALUE under, char \*name, VALUE superclass )  
 Defines a nested class under the class or module *under*.

VALUE **rb\_define\_module\_under**( VALUE under, char \*name )  
 Defines a nested module under the class or module *under*.

void **rb\_include\_module**( VALUE parent, VALUE module )  
 Includes the given *module* into the class or module *parent*.

void **rb\_extend\_object**( VALUE obj, VALUE module )  
 Extends *obj* with *module*.

VALUE **rb\_require**( const char \*name )  
 Equivalent to require *name*. Returns Qtrue or Qfalse.

## API: Defining Structures

VALUE **rb\_struct\_define**( char \*name, char \*attribute..., NULL )  
 Defines a new structure with the given attributes.

VALUE **rb\_struct\_new**( VALUE sClass, VALUE args..., NULL )  
 Creates an instance of *sClass* with the given attribute values.

VALUE **rb\_struct\_aref**( VALUE struct, VALUE idx )  
 Returns the element named or indexed by *idx*.

VALUE **rb\_struct\_aset**( VALUE struct, VALUE idx, VALUE val )  
 Sets the attribute named or indexed by *idx* to *val*.

## API: Defining Methods

In some of the function definitions that follow, the parameter *argc* specifies how many arguments a Ruby method takes. It may have the following values.

<i>argc</i>	Function Prototype
0..17	VALUE func(VALUE self, VALUE arg...) The C function will be called with this many actual arguments.
-1	VALUE func(int argc, VALUE *argv, VALUE self) The C function will be given a variable number of arguments passed as a C array.
-2	VALUE func(VALUE self, VALUE args) The C function will be given a variable number of arguments passed as a Ruby array.

In a function that has been given a variable number of arguments, you can use the C function `rb_scan_args` to sort things out (see below).



```
void rb_define_method(VALUE classmod, char *name,
 VALUE(*func)(), int argc)
 Defines an instance method in the class or module classmod with
 the given name, implemented by the C function func and taking argc
 arguments.
```

```
void rb_define_alloc_func(VALUE classmod, VALUE(*func)())
 Identifies the allocator for classmod.
```

```
void rb_define_module_function(VALUE module, char *name,
 VALUE(*func)(), int argc)
 Defines a method in class module with the given name, implemented
 by the C function func and taking argc arguments.
```

```
void rb_define_global_function(char *name, VALUE(*func)(),
 int argc)
 Defines a global function (a private method of Kernel) with the
 given name, implemented by the C function func and taking argc
 arguments.
```

```
void rb_define_singleton_method(VALUE classmod, char *name,
 VALUE(*func)(), int argc)
 Defines a singleton method in class classmod with the given name,
 implemented by the C function func and taking argc arguments.
```

```
int rb_scan_args(int argcount, VALUE *argv, char *fmt, ...)
 Scans the argument list and assigns to variables similar to scanf:
 fmt is a string containing zero, one, or two digits followed by some
 flag characters. The first digit indicates the count of mandatory argu-
 ments; the second is the count of optional arguments. A * means to
 pack the rest of the arguments into a Ruby array. A & means that
 an attached code block will be taken and assigned to the given vari-
 able (if no code block was given, Qnil will be assigned). After the
 fmt string, pointers to VALUE are given (as with scanf) to which the
 arguments are assigned.

 VALUE name, one, two, rest;
 rb_scan_args(argc, argv, "12", &name, &one, &two);
 rb_scan_args(argc, argv, "1*", &name, &rest);
```

```
void rb_undef_method(VALUE classmod, const char *name)
 Undefines the given method name in the given classmod class or
 module.
```

```
void rb_define_alias(VALUE classmod, const char *newname,
 const char *oldname)
 Defines an alias for oldname in class or module classmod.
```

## API: Defining Variables and Constants

void **rb\_define\_const**(VALUE classmod, char \*name, VALUE value)  
 Defines a constant in the class or module *classmod*, with the given *name* and *value*.

void **rb\_define\_global\_const**(char \*name, VALUE value)  
 Defines a global constant with the given *name* and *value*.

void **rb\_define\_variable**(const char \*name, VALUE \*object)  
 Exports the address of the given *object* that was created in C to the Ruby namespace as *name*. From Ruby, this will be a global variable, so *name* should start with a leading dollar sign. Be sure to honor Ruby's rules for allowed variable names; illegally named variables will not be accessible from Ruby.

void **rb\_define\_class\_variable**(VALUE class, const char \*name,  
 VALUE val)  
 Defines a class variable *name* (which must be specified with a @@ prefix) in the given *class*, initialized to *value*.

void **rb\_define\_virtual\_variable**(const char \*name,  
 VALUE(\*getter)(),  
 void(\*setter)())  
 Exports a virtual variable to a Ruby namespace as the global *\$name*. No actual storage exists for the variable; attempts to get and set the value will call the given functions with the prototypes.

```
VALUE getter(ID id, VALUE *data,
 struct global_entry *entry);
void setter(VALUE value, ID id, VALUE *data,
 struct global_entry *entry);
```

You will likely not need to use the *entry* parameter and can safely omit it from your function declarations.

void **rb\_define\_hooked\_variable**(const char \*name,  
 VALUE \*variable,  
 VALUE(\*getter)(),  
 void(\*setter)())  
 Defines functions to be called when reading or writing to *variable*. See also `rb_define_virtual_variable`.

void **rb\_define\_readonly\_variable**(const char \*name,  
 VALUE \*value)  
 Same as `rb_define_variable`, but read-only from Ruby.

```
void rb_define_attr(VALUE variable, const char *name, int read,
 int write)
 Creates accessor methods for the given variable, with the given
 name. If read is nonzero, create a read method; if write is nonzero,
 create a write method.
```

```
void rb_global_variable(VALUE *obj)
 Registers the given address with the garbage collector.
```

## API: Calling Methods

```
VALUE rb_create_new_instance((int argc, VALUE *argv,
 VALUE klass))
 Return a new instance of class klass. argv is a pointer to an array of
 argc parameters.
```

```
VALUE rb_funcall(VALUE recv, ID id, int argc, ...)
 Invokes the method given by id in the object recv with the given
 number of arguments argc and the arguments themselves (possibly
 none).
```

```
VALUE rb_funcall2(VALUE recv, ID id, int argc, VALUE *args)
 Invokes the method given by id in the object recv with the given
 number of arguments argc and the arguments themselves given in
 the C array args.
```

```
VALUE rb_funcall3(VALUE recv, ID id, int argc, VALUE *args)
 Same as rb_funcall2 but will not call private methods.
```

```
VALUE rb_apply(VALUE recv, ID name, int argc, VALUE args)
 Invokes the method given by id in the object recv with the given
 number of arguments argc and the arguments themselves given in
 the Ruby Array args.
```

```
ID rb_intern(char *name)
 Returns an ID for a given name. If the name does not exist, a symbol
 table entry will be created for it.
```

```
char * rb_id2name(ID id)
 Returns a name for the given id.
```

```
VALUE rb_call_super(int argc, VALUE *args)
 Calls the current method in the superclass of the current object.
```

## API: Exceptions

- void **rb\_raise**(VALUE exception, const char \*fmt, ...)  
 Raises an *exception*. The given string *fmt* and remaining arguments are interpreted as with `printf`.
- void **rb\_fatal**(const char \*fmt, ...)  
 Raises a Fatal exception, terminating the process. No rescue blocks are called, but ensure blocks will be called. The given string *fmt* and remaining arguments are interpreted as with `printf`.
- void **rb\_bug**(const char \*fmt, ...)  
 Terminates the process immediately—no handlers of any sort will be called. The given string *fmt* and remaining arguments are interpreted as with `printf`. You should call this function only if a fatal bug has been exposed. You don't write fatal bugs, do you?
- void **rb\_sys\_fail**(const char \*msg)  
 Raises a platform-specific exception corresponding to the last known system error, with the given *msg*.
- VALUE **rb\_rescue**(VALUE (\*body)(), VALUE args, VALUE(\*rescue)(), VALUE rargs)  
 Executes *body* with the given *args*. If a StandardError exception is raised, then execute *rescue* with the given *rargs*.
- VALUE **rb\_ensure**(VALUE(\*body)(), VALUE args, VALUE(\*ensure)(), VALUE eargs)  
 Executes *body* with the given *args*. Whether or not an exception is raised, execute *ensure* with the given *rargs* after *body* has completed.
- VALUE **rb\_protect**(VALUE (\*body)(), VALUE args, int \*result)  
 Executes *body* with the given *args* and returns nonzero in *result* if any exception was raised.
- void **rb\_notimplement**( )  
 Raises a NotImpError exception to indicate that the enclosed function is not implemented yet or not available on this platform.
- void **rb\_exit**(int status)  
 Exits Ruby with the given *status*. Raises a SystemExit exception and calls registered exit functions and finalizers.

void **rb\_warn**(const char \*fmt, ...)  
 Unconditionally issues a warning message to standard error. The given string *fmt* and remaining arguments are interpreted as with `printf`.

void **rb\_warning**(const char \*fmt, ...)  
 Conditionally issues a warning message to standard error if Ruby was invoked with the `-w` flag. The given string *fmt* and remaining arguments are interpreted as with `printf`.

## API: Iterators

void **rb\_iter\_break**( )  
 Breaks out of the enclosing iterator block.

VALUE **rb\_each**(VALUE obj)  
 Invokes the `each` method of the given *obj*.

VALUE **rb\_yield**(VALUE arg)  
 Transfers execution to the iterator block in the current context, passing *arg* as an argument. Multiple values may be passed in an array.

int **rb\_block\_given\_p**( )  
 Returns true if `yield` would execute a block in the current context—that is, if a code block was passed to the current method and is available to be called.

VALUE **rb\_iterate**(VALUE (\*method)(), VALUE args,  
 VALUE (\*block)(), VALUE arg2)  
 Invokes *method* with argument *args* and block *block*. A `yield` from that method will invoke *block* with the argument given to `yield` and a second argument *arg2*.

VALUE **rb\_catch**(const char \*tag, VALUE (\*proc)(), VALUE value)  
 Equivalent to Ruby `catch`.

void **rb\_throw**(const char \*tag , VALUE value)  
 Equivalent to Ruby `throw`.

## API: Accessing Variables

VALUE **rb\_iv\_get**(VALUE obj, char \*name)  
 Returns the instance variable *name* (which must be specified with a `@` prefix) from the given *obj*.

VALUE **rb\_ivar\_get**( VALUE obj, ID name )  
Returns the instance variable *name* from the given *obj*.

VALUE **rb\_iv\_set**( VALUE obj, char \*name, VALUE value )  
Sets the value of the instance variable *name* (which must be specified with a @ prefix) in the given *obj* to *value*. Returns *value*.

VALUE **rb\_ivar\_set**( VALUE obj, ID name, VALUE value )  
Sets the value of the instance variable *name* in the given *obj* to *value*. Returns *value*.

VALUE **rb\_gv\_set**( const char \*name, VALUE value )  
Sets the global variable *name* (the \$ prefix is optional) to *value*. Returns *value*.

VALUE **rb\_gv\_get**( const char \*name )  
Returns the global variable *name* (the \$ prefix is optional).

void **rb\_cvar\_set**( VALUE class, ID name, VALUE val )  
Sets the class variable *name* in the given *class* to *value*.

VALUE **rb\_cvar\_get**( VALUE class, ID name )  
Returns the class variable *name* from the given *class*.

int **rb\_cvar\_defined**( VALUE class, ID name )  
Returns Qtrue if the given class variable *name* has been defined for *class*; otherwise, returns Qfalse.

void **rb\_cv\_set**( VALUE class, const char \*name, VALUE val )  
Sets the class variable *name* (which must be specified with a @@ prefix) in the given *class* to *value*.

VALUE **rb\_cv\_get**( VALUE class, const char \*name )  
Returns the class variable *name* (which must be specified with a @@ prefix) from the given *class*.

## API: Object Status

**OBJ\_TAINT**( VALUE obj )  
Marks the given *obj* as tainted.

int **OBJ\_TAINTED**( VALUE obj )  
Returns nonzero if the given *obj* is tainted.

**OBJ\_FREEZE**( VALUE obj )  
Marks the given *obj* as frozen.

int **OBJ\_FROZEN**( VALUE obj )  
Returns nonzero if the given *obj* is frozen.

1.8

**SafeStringValue**( VALUE str )  
Raises `SecurityError` if current safe level > 0 and *str* is tainted, or raises a `TypeError` if *str* is not a `T_STRING` or if `$SAFE` >= 4.

int **rb\_safe\_level**( )  
Returns the current safe level.

void **rb\_secure**( int level )  
Raises `SecurityError` if *level* <= current safe level.

void **rb\_set\_safe\_level**( int newlevel )  
Sets the current safe level to *newlevel*.

## API: Commonly Used Methods

VALUE **rb\_ary\_new**( )  
Returns a new Array with default size.

VALUE **rb\_ary\_new2**( long length )  
Returns a new Array of the given *length*.

VALUE **rb\_ary\_new3**( long length, ... )  
Returns a new Array of the given *length* and populated with the remaining arguments.

VALUE **rb\_ary\_new4**( long length, VALUE \*values )  
Returns a new Array of the given *length* and populated with the C array *values*.

void **rb\_ary\_store**( VALUE self, long index, VALUE value )  
Stores *value* at *index* in array *self*.

VALUE **rb\_ary\_push**( VALUE self, VALUE value )  
Pushes *value* onto the end of array *self*. Returns *value*.

VALUE **rb\_ary\_pop**( VALUE self )  
Removes and returns the last element from the array *self*.

VALUE **rb\_ary\_shift**( VALUE self )  
Removes and returns the first element from the array *self*.

- VALUE **rb\_ary\_unshift**( VALUE self, VALUE value )  
Pushes *value* onto the front of array *self*. Returns *value*.
- VALUE **rb\_ary\_entry**( VALUE self, long index )  
Returns array *self*'s element at *index*.
- int **rb\_respond\_to**( VALUE self, ID method )  
Returns nonzero if *self* responds to *method*.
- VALUE **rb\_thread\_create**( VALUE (\*func)(), void \*data )  
Runs *func* in a new thread, passing *data* as an argument.
- VALUE **rb\_hash\_new**( )  
Returns a new, empty Hash.
- VALUE **rb\_hash\_aref**( VALUE self, VALUE key )  
Returns the element corresponding to *key* in *self*.
- VALUE **rb\_hash\_aset**( VALUE self, VALUE key, VALUE value )  
Sets the value for *key* to *value* in *self*. Returns *value*.
- VALUE **rb\_obj\_is\_instance\_of**( VALUE obj, VALUE klass )  
Returns Qtrue if *obj* is an instance of *klass*.
- VALUE **rb\_obj\_is\_kind\_of**( VALUE obj, VALUE klass )  
Returns Qtrue if *klass* is the class of *obj* or *klass* is one of the super-classes of the class of *obj*.
- VALUE **rb\_str\_new**( const char \*src, long length )  
Returns a new String initialized with *length* characters from *src*.
- VALUE **rb\_str\_new2**( const char \*src )  
Returns a new String initialized with the null-terminated C string *src*.
- VALUE **rb\_str\_dup**( VALUE str )  
Returns a new String object duplicated from *str*.
- VALUE **rb\_str\_cat**( VALUE self, const char \*src, long length )  
Concatenates *length* characters from the string *src* onto the String *self*. Returns *self*.
- VALUE **rb\_str\_concat**( VALUE self, VALUE other )  
Concatenates *other* onto the String *self*. Returns *self*.
- VALUE **rb\_str\_split**( VALUE self, const char \*delim )  
Returns an array of String objects created by splitting *self* on *delim*.



---

**Part III**

**Ruby Crystallized**

---

# The Ruby Language

---

This chapter is a bottom-up look at the Ruby language. Most of what appears here is the syntax and semantics of the language itself—we mostly ignore the built-in classes and modules (these are covered in depth starting on page 402). However, Ruby sometimes implements features in its libraries that in most languages would be part of the basic syntax. We’ve included these methods here and have tried to flag them with “Library” in the margin.

The contents of this chapter may look familiar—with good reason. We’ve covered just about all of this in the earlier tutorial chapters. Consider this chapter to be a self-contained reference to the core Ruby language.

## Source Layout

Ruby programs are written in 7-bit ASCII, Kanji (using EUC or SJIS), or UTF-8. If a code set other than 7-bit ASCII is used, the KCODE option must be set appropriately, as shown on page 169.

Ruby is a line-oriented language. Ruby expressions and statements are terminated at the end of a line unless the parser can determine that the statement is incomplete—for example if the last token on a line is an operator or comma. A semicolon can be used to separate multiple expressions on a line. You can also put a backslash at the end of a line to continue it onto the next. Comments start with # and run to the end of the physical line. Comments are ignored during syntax analysis.

```
a = 1
b = 2; c = 3
d = 4 + 5 +
 6 + 7 # no '\ ' needed
e = 8 + 9 \
 + 10 # '\ ' needed
```

Physical lines between a line starting with `=begin` and a line starting with `=end` are ignored by Ruby and may be used to comment out sections of code or to embed documentation.

Ruby reads its program input in a single pass, so you can pipe programs to the Ruby interpreter’s standard input stream.

```
echo 'puts "Hello"' | ruby
```

If Ruby comes across a line anywhere in the source containing just “`__END__`”, with no leading or trailing whitespace, it treats that line as the end of the program—any subsequent lines will not be treated as program code. However, these lines can be read into the running program using the global IO object `DATA`, described on page 322.

## BEGIN and END Blocks

Every Ruby source file can declare blocks of code to be run as the file is being loaded (the `BEGIN` blocks) and after the program has finished executing (the `END` blocks).

```
BEGIN {
 begin code
}

END {
 end code
}
```

A program may include multiple `BEGIN` and `END` blocks. `BEGIN` blocks are executed in the order they are encountered. `END` blocks are executed in reverse order.

## General Delimited Input

As well as the normal quoting mechanism, alternative forms of literal strings, arrays, regular expressions, and shell commands are specified using a generalized delimited syntax. All these literals start with a percent character, followed by a single character that identifies the literal’s type. These characters are summarized in Table 22.1 on the following page; the actual literals are described in the corresponding sections later in this chapter.

1.8

Following the type character is a delimiter, which can be any nonalphabetic or non-multibyte character. If the delimiter is one of the characters `(`, `[`, `{`, or `<`, the literal consists of the characters up to the matching closing delimiter, taking account of nested delimiter pairs. For all other delimiters, the literal comprises the characters up to the next occurrence of the delimiter character.

```
%q/this is a string/
%q-string-
%q(a (nested) string)
```

Table 22.1. General delimited input

Type	Meaning	See Page
%q	Single-quoted string	305
%Q, %	Double-quoted string	305
%w, %W	Array of strings	307
%r	Regular expression pattern	309
%x	Shell command	323

Delimited strings may continue over multiple lines; the line endings and all spaces at the start of continuation lines will be included in the string.

```
meth = %q{def fred(a)
 a.each {|i| puts i }
end}
```

## The Basic Types

The basic types in Ruby are numbers, strings, arrays, hashes, ranges, symbols, and regular expressions.

### Integer and Floating-Point Numbers

Ruby integers are objects of class `Fixnum` or `Bignum`. `Fixnum` objects hold integers that fit within the native machine word minus 1 bit. Whenever a `Fixnum` exceeds this range, it is automatically converted to a `Bignum` object, whose range is effectively limited only by available memory. If an operation with a `Bignum` result has a final value that will fit in a `Fixnum`, the result will be returned as a `Fixnum`.

1.8

Integers are written using an optional leading sign, an optional base indicator (0 for octal, 0d for decimal, 0x for hex, or 0b for binary), followed by a string of digits in the appropriate base. Underscore characters are ignored in the digit string.

```
123456 => 123456 # Fixnum
0d123456 => 123456 # Fixnum
123_456 => 123456 # Fixnum - underscore ignored
-543 => -543 # Fixnum - negative number
0xaabb => 43707 # Fixnum - hexadecimal
0377 => 255 # Fixnum - octal
-0b10_1010 => -42 # Fixnum - binary (negated)
123_456_789_123_456_789 => 123456789123456789 # Bignum
```

You can get the integer value corresponding to an ASCII character by preceding that character with a question mark. Control characters can be generated using `?\C-x` and

?\cx (the control version of x is x&0x9f). Meta characters (x | 0x80) can be generated using ?\M-x. The combination of meta and control is generated using and ?\M-\C-x. You can get the integer value of a backslash character using the sequence ?\.

```
?a => 97 # ASCII character
?\n => 10 # code for a newline (0x0a)
?\C-a => 1 # control a = ?A & 0x9f = 0x01
?\M-a => 225 # meta sets bit 7
?\M-\C-a => 129 # meta and control a
?\C-? => 127 # delete character
```

## 1.8

A numeric literal with a decimal point and/or an exponent is turned into a Float object, corresponding to the native architecture's double data type. You must follow the decimal point with a digit, as 1.e3 tries to invoke the method e3 in class Fixnum. As of Ruby 1.8 you must also place at least one digit before the decimal point.

```
12.34 → 12.34
-0.1234e2 → -12.34
1234e-2 → 12.34
```

## Strings

Ruby provides a number of mechanisms for creating literal strings. Each generates objects of type String. The different mechanisms vary in terms of how a string is delimited and how much substitution is done on the literal's content.

Single-quoted string literals ('stuff' and %q/stuff/) undergo the least substitution. Both convert the sequence \\ into a single backslash, and the form with single quotes converts \' into a single quote. All other backslashes appear literally in the string.

```
'hello' → hello
'a backslash \\\' → a backslash \'
%q/simple string/ → simple string
%q(nesting (really) works) → nesting (really) works
%q no_blanks_here ; → no_blanks_here
```

Double-quoted strings ("stuff", %Q/stuff/, and %/stuff/) undergo additional substitutions, shown in Table 22.2 on the next page.

```
a = 123
"\123mile" → Smile
"Say \"Hello\"" → Say "Hello"
%Q!"I said 'nuts'," I said! → "I said 'nuts'," I said
%Q{Try #{a + 1}, not #{a - 1}} → Try 124, not 122
%<Try #{a + 1}, not #{a - 1}> → Try 124, not 122
"Try #{a + 1}, not #{a - 1}" → Try 124, not 122
%{ #{ a = 1; b = 2; a + b } } → 3
```

Strings can continue across multiple input lines, in which case they will contain newline characters. It is also possible to use here documents to express long string literals. Whenever Ruby parses the sequence <<identifier or <<quoted string, it replaces it with

Table 22.2. Substitutions in double-quoted strings

<code>\a</code>	Bell/alert (0x07)	<code>\nnn</code>	Octal <i>nnn</i>
<code>\b</code>	Backspace (0x08)	<code>\xnn</code>	Hex <i>nn</i>
<code>\e</code>	Escape (0x1b)	<code>\cx</code>	Control- <i>x</i>
<code>\f</code>	Formfeed (0x0c)	<code>\C-x</code>	Control- <i>x</i>
<code>\n</code>	Newline (0x0a)	<code>\M-x</code>	Meta- <i>x</i>
<code>\r</code>	Return (0x0d)	<code>\M-\C-x</code>	Meta-control- <i>x</i>
<code>\s</code>	Space (0x20)	<code>\x</code>	<i>x</i>
<code>\t</code>	Tab (0x09)	<code>#{code}</code>	Value of <i>code</i>
<code>\v</code>	Vertical tab (0x0b)		

a string literal built from successive logical input lines. It stops building the string when it finds a line that starts with *identifier* or *quoted string*. You can put a minus sign immediately after the `<<` characters, in which case the terminator can be indented from the left margin. If a quoted string was used to specify the terminator, its quoting rules will be applied to the here document; otherwise, double-quoting rules apply.

```
print <<HERE
Double quoted \
here document.
It is #{Time.now}
HERE
print <<-'THERE'
 This is single quoted.
 The above used #{Time.now}
 THERE
```

*produces:*

```
Double quoted here document.
It is Tue Oct 26 11:32:15 CDT 2004
 This is single quoted.
 The above used #{Time.now}
```

Adjacent single- and double-quoted strings in the input are concatenated to form a single String object.

```
'Con' "cat" 'en' "ate" → "Concatenate"
```

Strings are stored as sequences of 8-bit bytes,<sup>1</sup> and each byte may contain any of the 256 8-bit values, including null and newline. The substitution sequences in Table 22.2 allow nonprinting characters to be inserted conveniently and portably.

1. For use in Japan, the `jcode` library supports a set of operations of strings written with EUC, SJIS, or UTF-8 encoding. The underlying string, however, is still accessed as a series of bytes.

Every time a string literal is used in an assignment or as a parameter, a new `String` object is created.

```
3.times do
 print 'hello'.object_id, " "
end
```

produces:

```
937140 937110 937080
```

The documentation for class `String` starts on page [585](#).

## Ranges

Outside the context of a conditional expression, `expr..expr` and `expr...expr` construct `Range` objects. The two-dot form is an inclusive range; the one with three dots is a range that excludes its last element. See the description of class `Range` on page [576](#) for details. Also see the description of conditional expressions on page [327](#) for other uses of ranges.

## Arrays

Literals of class `Array` are created by placing a comma-separated series of object references between square brackets. A trailing comma is ignored.

```
arr = [fred, 10, 3.14, "This is a string", barney("pebbles"),]
```

1.8

Arrays of strings can be constructed using the shortcut notations `%w` and `%W`. The lowercase form extracts space-separated tokens into successive elements of the array. No substitution is performed on the individual strings. The uppercase version also converts the words to an array, but performs all the normal double-quoted string substitutions on each individual word. A space between words can be escaped with a backslash. This is a form of general delimited input, described on pages [303–304](#).

```
arr = %w(fred wilma barney betty great\ gazoo)
arr → ["fred", "wilma", "barney", "betty", "great gazoo"]
arr = %w(Hey!\tIt is now -#{Time.now}-)
arr → ["Hey!\tIt", "is", "now", "-#{Time.now}-"]
arr = %W(Hey!\tIt is now -#{Time.now}-)
arr → ["Hey!\tIt", "is", "now", "-Tue Oct 26 11:32:16 CDT 2004-"]
```

## Hashes

A literal Ruby Hash is created by placing a list of key/value pairs between braces, with either a comma or the sequence `=>` between the key and the value. A trailing comma is ignored.

```

colors = { "red" => 0xf00,
 "green" => 0x0f0,
 "blue" => 0x00f
 }

```

There is no requirement for the keys and/or values in a particular hash to have the same type.

## Requirements for a Hash Key

Hash keys must respond to the message `hash` by returning a hash code, and the hash code for a given key must not change. The keys used in hashes must also be comparable using `eql?`. If `eql?` returns `true` for two keys, then those keys must also have the same hash code. This means that certain classes (such as `Array` and `Hash`) can't conveniently be used as keys, because their hash values can change based on their contents.

If you keep an external reference to an object that is used as a key, and use that reference to alter the object, thus changing its hash code, the hash lookup based on that key may not work.

1.8

Because strings are the most frequently used keys, and because string contents are often changed, Ruby treats string keys specially. If you use a `String` object as a hash key, the hash will duplicate the string internally and will use that copy as its key. The copy will be frozen. Any changes made to the original string will not affect the hash.

If you write your own classes and use instances of them as hash keys, you need to make sure that either (a) the hashes of the key objects don't change once the objects have been created or (b) you remember to call the `Hash#rehash` method to reindex the hash whenever a key hash *is* changed.

## Symbols

1.8

A Ruby symbol is an identifier corresponding to a string of characters, often a name. You construct the symbol for a name by preceding the name with a colon, and you can construct the symbol for an arbitrary string by preceding a string literal with a colon. Substitution occurs in double-quoted strings. A particular name or string will always generate the same symbol, regardless of how that name is used within the program.

```

:Object
:my_variable
:"Ruby rules"
a = "cat"
:'catsup' → :catsup
:"#{a}sup" → :catsup
:'#{a}sup' → :"\#{a}sup"

```

Other languages call this process *interning*, and call symbols *atoms*.



## Regular Expressions

Regular expression literals are objects of type `RegExp`. They are created explicitly by calling the `RegExp.new` constructor or implicitly by using the literal forms, `/pattern/` and `%r{pattern}`. The `%r` construct is a form of general delimited input (described on pages 303–304).

```

 /pattern/
 /pattern/options
 %r{pattern}
 %r{pattern}options
 RegExp.new('pattern' [, options])

```

## Regular Expression Options

A regular expression may include one or more options that modify the way the pattern matches strings. If you're using literals to create the `RegExp` object, then the options are one or more characters placed immediately after the terminator. If you're using `RegExp.new`, the options are constants used as the second parameter of the constructor.

1.8

- i *Case Insensitive*. The pattern match will ignore the case of letters in the pattern and string. Setting `$=` to make matches case insensitive is now deprecated.
- o *Substitute Once*. Any `#. . .` substitutions in a particular regular expression literal will be performed just once, the first time it is evaluated. Otherwise, the substitutions will be performed every time the literal generates a `RegExp` object.
- m *Multiline Mode*. Normally, `"."` matches any character except a newline. With the `/m` option, `"."` matches any character.
- x *Extended Mode*. Complex regular expressions can be difficult to read. The `x` option allows you to insert spaces, newlines, and comments in the pattern to make it more readable.

Another set of options allows you to set the language encoding of the regular expression. If none of these options is specified, the interpreter's default encoding (set using `-K` or `$KCODE`) is used.

```

n: no encoding (ASCII) e: EUC
s: SJIS u: UTF-8

```

## Regular Expression Patterns

*regular characters*

All characters except `.`, `|`, `(`, `)`, `[`, `\`, `^`, `{`, `+`, `$`, `*`, and `?` match themselves. To match one of these characters, precede it with a backslash.

- `^` Matches the beginning of a line.
- `$` Matches the end of a line.
- `\A` Matches the beginning of the string.

<code>\z</code>	Matches the end of the string.
<code>\Z</code>	Matches the end of the string <i>unless</i> the string ends with a <code>\n</code> , in which case it matches just before the <code>\n</code> .
<code>\b</code> , <code>\B</code>	Match word boundaries and nonword boundaries respectively.
<code>\G</code>	The position where a previous repetitive search completed (but only in some situations). See the additional information on the next page.
<code>[characters]</code>	A bracket expression matches any of a list of characters between the brackets. The characters <code> </code> , <code>.</code> , <code>(</code> , <code>)</code> , <code>[</code> , <code>^</code> , <code>\$</code> , <code>*</code> , and <code>?</code> , which have special meanings elsewhere in patterns, lose their special significance between brackets. The sequences <code>\nnn</code> , <code>\xnn</code> , <code>\cx</code> , <code>\C-x</code> , <code>\M-x</code> , and <code>\M-\C-x</code> have the meanings shown in Table 22.2 on page 306. The sequences <code>\d</code> , <code>\D</code> , <code>\s</code> , <code>\S</code> , <code>\w</code> , and <code>\W</code> are abbreviations for groups of characters, as shown in Table 5.1 on page 68. The sequence <code>[:class:]</code> matches a POSIX character class, also shown in Table 5.1 on page 68. (Note that the open and close brackets are part of the class, so the pattern <code>/[_[:digit:]]/</code> would match a digit or an underscore.) The sequence <code>c<sub>1</sub>-c<sub>2</sub></code> represents all the characters between <code>c<sub>1</sub></code> and <code>c<sub>2</sub></code> , inclusive. Literal <code>]</code> or <code>-</code> characters must appear immediately after the opening bracket. A caret character ( <code>^</code> ) immediately following the opening bracket negates the sense of the match—the pattern matches any character that isn’t in the character class.
<code>\d</code> , <code>\s</code> , <code>\w</code>	Abbreviations for character classes that match digits, whitespace, and word characters, respectively. These abbreviations are summarized in Table 5.1 on page 68.
<code>\D</code> , <code>\S</code> , <code>\W</code>	The negated forms of <code>\d</code> , <code>\s</code> , and <code>\w</code> , matching characters that are not digits, whitespace, or word characters.
<code>.</code> (period)	Appearing outside brackets, matches any character except a newline. (With the <code>/m</code> option, it matches newline, too).
<code>re*</code>	Matches zero or more occurrences of <code>re</code> .
<code>re+</code>	Matches one or more occurrences of <code>re</code> .
<code>re{m,n}</code>	Matches at least “m” and at most “n” occurrences of <code>re</code> .
<code>re{m,}</code>	Matches at least “m” occurrences of <code>re</code> .
<code>re{m}</code>	Matches exactly “m” occurrences of <code>re</code> .
<code>re?</code>	Matches zero or one occurrence of <code>re</code> . The <code>*</code> , <code>+</code> , and <code>{m,n}</code> modifiers are greedy by default. Append a question mark to make them minimal.
<code>re1 re2</code>	Matches either <code>re1</code> or <code>re2</code> . <code> </code> has a low precedence.

(...)

Parentheses are used to group regular expressions. For example, the pattern `/abc+/` matches a string containing an *a*, a *b*, and one or more *c*'s. `/(abc)+/` matches one or more sequences of *abc*. Parentheses are also used to collect the results of pattern matching. For each opening parenthesis, Ruby stores the result of the partial match between it and the corresponding closing parenthesis as successive groups. Within the same pattern, `\1` refers to the match of the first group, `\2` the second group, and so on. Outside the pattern, the special variables `$1`, `$2`, and so on, serve the same purpose.

### 1.8

The anchor `\G` works with the repeating match methods `String#gsub`, `String#gsub!`, `String#index`, and `String#scan`. In a repetitive match, it represents the position in the string where the last match in the iteration ended. `\G` initially points to the start of the string (or to the character referenced by the second parameter of `String#index`).

```
"a01b23c45 d56".scan(/[a-z]\d+/) → ["a01", "b23", "c45", "d56"]
"a01b23c45 d56".scan(/\G[a-z]\d+/) → ["a01", "b23", "c45"]
"a01b23c45 d56".scan(/\A[a-z]\d+/) → ["a01"]
```

## Substitutions

`#{...}` Performs an expression substitution, as with strings. By default, the substitution is performed each time a regular expression literal is evaluated. With the `/o` option, it is performed just the first time.

`\0`, `\1`, `\2`, ... `\9`, `\&`, `\``, `\'`, `\+`

Substitutes the value matched by the *n*th grouped subexpression, or by the entire match, pre- or postmatch, or the highest group.

## Regular Expression Extensions

In common with Perl and Python, Ruby regular expressions offer some extensions over traditional Unix regular expressions. All the extensions are entered between the characters `(?` and `)`. The parentheses that bracket these extensions are groups, but they do not generate back references: they do not set the values of `\1` and `$1` etc.

`(?# comment)`

Inserts a comment into the pattern. The content is ignored during pattern matching.

`(?:re)`

Makes *re* into a group without generating backreferences. This is often useful when you need to group a set of constructs but don't want the group to set the value of `$1` or whatever. In the example that follows, both patterns match a date with either colons or spaces between the month, day, and year. The first form stores the separator character in `$2` and `$4`, but the second pattern doesn't store the separator in an external variable.

```

date = "12/25/01"
date =~ %r{(\d+)(/|:)(\d+)(/|:)(\d+)}
[$1,$2,$3,$4,$5] → ["12", "/", "25", "/", "01"]
date =~ %r{(\d+)(?:/|:)(\d+)(?:/|:)(\d+)}
[$1,$2,$3] → ["12", "25", "01"]

```

- (?=re) Matches *re* at this point, but does not consume it (also known charmingly as *zero-width positive lookahead*). This lets you look forward for the context of a match without affecting `$&`. In this example, the `scan` method matches words followed by a comma, but the commas are not included in the result.

```

str = "red, white, and blue"
str.scan(/[a-z]+(?=,)/) → ["red", "white"]

```

- (?!re) Matches if *re* does not match at this point. Does not consume the match (zero-width negative lookahead). For example, `/hot(?!dog)(\w+)/` matches any word that contains the letters *hot* that aren't followed by *dog*, returning the end of the word in `$1`.

- (?>re) Nests an independent regular expression within the first regular expression. This expression is anchored at the current match position. If it consumes characters, these will no longer be available to the higher-level regular expression. This construct therefore inhibits backtracking, which can be a performance enhancement. For example, the pattern `/a.*b.*a/` takes exponential time when matched against a string containing an *a* followed by a number of *b*'s, but with no trailing *a*. However, this can be avoided by using a nested regular expression `/a(?>.*b).*a/`. In this form, the nested expression consumes all the the input string up to the last possible *b* character. When the check for a trailing *a* then fails, there is no need to backtrack, and the pattern match fails promptly.

```

require 'benchmark'
include Benchmark
str = "a" + ("b" * 5000)
bm(8) do |test|
 test.report("Normal:") { str =~ /a.*b.*a/ }
 test.report("Nested:") { str =~ /a(?>.*b).*a/ }
end

```

*produces:*

	user	system	total	real
Normal:	1.070000	0.010000	1.080000	( 1.762961)
Nested:	0.000000	0.000000	0.000000	( 0.000814)

- (?imx) Turns on the corresponding *i*, *m*, or *x* option. If used inside a group, the effect is limited to that group.

- (?-imx) Turns off the *i*, *m*, or *x* option.
- (?imx:re) Turns on the *i*, *m*, or *x* option for *re*.
- (?-imx:re) Turns off the *i*, *m*, or *x* option for *re*.

## Names

Ruby names are used to refer to constants, variables, methods, classes, and modules. The first character of a name helps Ruby to distinguish its intended use. Certain names, listed in Table 22.3 on the following page, are reserved words and should not be used as variable, method, class, or module names.

Method names are described in the section beginning on page 330.

In these descriptions, *lowercase letter* means the characters *a* through *z*, as well as `_`, the underscore. *Uppercase letter* means *A* through *Z*, and *digit* means *0* through *9*. A *name* is an uppercase letter, lowercase letters, or an underscore, followed by *name characters*: any combination of upper- and lowercase letters, underscores, and digits.

A **local variable name** consists of a lowercase letter followed by name characters. It is conventional to use underscores rather than camelCase to write multiword names, but the interpreter does not enforce this.

```
fred anObject _x three_two_one
```

An **instance variable name** starts with an “at” sign (@) followed by a name. It is generally a good idea to use a lowercase letter after the @.

```
@name @_ @size
```

A **class variable name** starts with two “at” signs (@@) followed by a name.

```
@@name @@_ @@Size
```

A **constant name** starts with an uppercase letter followed by name characters. Class names and module names are constants and follow the constant naming conventions. By convention, constant object references are normally spelled using uppercase letters and underscores throughout, while class and module names are MixedCase.

```
module Math
 ALMOST_PI = 22.0/7.0
end
class Blob
end
```

**Global variables**, and some special system variables, start with a dollar sign (\$) followed by name characters. In addition, Ruby defines a set of two-character global variable names in which the second character is a punctuation character. These predefined

Table 22.3. Reserved words

<code>__FILE__</code>	<code>and</code>	<code>def</code>	<code>end</code>	<code>in</code>	<code>or</code>	<code>self</code>	<code>unless</code>
<code>__LINE__</code>	<code>begin</code>	<code>defined?</code>	<code>ensure</code>	<code>module</code>	<code>redo</code>	<code>super</code>	<code>until</code>
<code>BEGIN</code>	<code>break</code>	<code>do</code>	<code>false</code>	<code>next</code>	<code>rescue</code>	<code>then</code>	<code>when</code>
<code>END</code>	<code>case</code>	<code>else</code>	<code>for</code>	<code>nil</code>	<code>retry</code>	<code>true</code>	<code>while</code>
<code>alias</code>	<code>class</code>	<code>elsif</code>	<code>if</code>	<code>not</code>	<code>return</code>	<code>undef</code>	<code>yield</code>

1.8

variables are listed starting on page 318. Finally, a global variable name can be formed using `$-` followed by a single letter or underscore. These latter variables typically mirror the setting of the corresponding command-line option (see the table starting on page 320 for details).

```
$params $PROGRAM $! $_ $-a $-K
```

## Variable/Method Ambiguity

When Ruby sees a name such as `a` in an expression, it needs to determine if it is a local variable reference or a call to a method with no parameters. To decide which is the case, Ruby uses a heuristic. As Ruby parses a source file, it keeps track of symbols that have been assigned to. It assumes that these symbols are variables. When it subsequently comes across a symbol that could be a variable or a method call, it checks to see if it has seen a prior assignment to that symbol. If so, it treats the symbol as a variable; otherwise it treats it as a method call. As a somewhat pathological case of this, consider the following code fragment, submitted by Clemens Hintze.

```
def a
 print "Function 'a' called\n"
 99
end
for i in 1..2
 if i == 2
 print "a=", a, "\n"
 else
 a = 1
 print "a=", a, "\n"
 end
end
```

*produces:*

```
a=1
Function 'a' called
a=99
```

During the parse, Ruby sees the use of `a` in the first print statement and, as it hasn't yet seen any assignment to `a`, assumes that it is a method call. By the time it gets to the second print statement, though, it *has* seen an assignment, and so treats `a` as a variable.

Note that the assignment does not have to be executed—Ruby just has to have seen it. This program does not raise an error.

```
a = 1 if false; a
```

## Variables and Constants

Ruby variables and constants hold references to objects. Variables themselves do not have an intrinsic type. Instead, the type of a variable is defined solely by the messages to which the object referenced by the variable responds.<sup>2</sup>

A Ruby *constant* is also a reference to an object. Constants are created when they are first assigned to (normally in a class or module definition). Ruby, unlike less flexible languages, lets you alter the value of a constant, although this will generate a warning message.

```
MY_CONST = 1
MY_CONST = 2 # generates a warning
```

*produces:*

```
prog.rb:2: warning: already initialized constant MY_CONST
```

Note that although constants should not be changed, you can alter the internal states of the objects they reference.

```
MY_CONST = "Tim"
MY_CONST[0] = "J" # alter string referenced by constant
MY_CONST → "Jim"
```

Assignment potentially *aliases* objects, giving the same object different names.

## Scope of Constants and Variables

**Constants** defined within a class or module may be accessed unadorned anywhere within the class or module. Outside the class or module, they may be accessed using the scope operator, `::`: prefixed by an expression that returns the appropriate class or module object. Constants defined outside any class or module may be accessed unadorned or by using the scope operator `::` with no prefix. Constants may not be defined in methods. Constants may be added to existing classes and modules from the outside by using the class or module name and the scope operator before the constant name.

1.8

```
OUTER_CONST = 99
```

---

2. When we say that a variable is not typed, we mean that any given variable can at different times hold references to objects of many different types.

```

class Const
 def get_const
 CONST
 end
 CONST = OUTER_CONST + 1
end

Const.new.get_const → 100
Const::CONST → 100
::OUTER_CONST → 99
Const::NEW_CONST = 123

```

**Global variables** are available throughout a program. Every reference to a particular global name returns the same object. Referencing an uninitialized global variable returns `nil`.

**Class variables** are available throughout a class or module body. Class variables must be initialized before use. A class variable is shared among all instances of a class and is available within the class itself.

```

class Song
 @@count = 0
 def initialize
 @@count += 1
 end
 def Song.get_count
 @@count
 end
end

```

Class variables belong to the innermost enclosing class or module. Class variables used at the top level are defined in `Object` and behave like global variables. Class variables defined within singleton methods belong to the top level (although this usage is deprecated and generates a warning). In Ruby 1.9, class variables will be private to the defining class.

1.8

```

class Holder
 @@var = 99
 def Holder.var=(val)
 @@var = val
 end
 def var
 @@var
 end
end

@@var = "top level variable"
a = Holder.new

a.var → 99

Holder.var = 123
a.var → 123

```



```

This references the top-level object
def a.get_var
 @@var
end
a.get_var → "top level variable"

```

Class variables are shared by children of the class in which they are first defined.

```

class Top
 @@A = 1
 def dump
 puts values
 end
 def values
 "#{self.class.name}: A = #@@A"
 end
end
class MiddleOne < Top
 @@B = 2
 def values
 super + ", B = #@@B"
 end
end
class MiddleTwo < Top
 @@B = 3
 def values
 super + ", B = #@@B"
 end
end
class BottomOne < MiddleOne; end
class BottomTwo < MiddleTwo; end
Top.new.dump
MiddleOne.new.dump
MiddleTwo.new.dump
BottomOne.new.dump
BottomTwo.new.dump

```

*produces:*

```

Top: A = 1
MiddleOne: A = 1, B = 2
MiddleTwo: A = 1, B = 3
BottomOne: A = 1, B = 2
BottomTwo: A = 1, B = 3

```

**Instance variables** are available within instance methods throughout a class body. Referencing an uninitialized instance variable returns `nil`. Each instance of a class has a unique set of instance variables. Instance variables are not available to class methods (although classes themselves also may have instance variables—see page 371).

**Local variables** are unique in that their scopes are statically determined but their existence is established dynamically.

A local variable is created dynamically when it is first assigned a value during program execution. However, the scope of a local variable is statically determined to be the immediately enclosing block, method definition, class definition, module definition, or top-level program. Referencing a local variable that is in scope but that has not yet been created generates a `NameError` exception. Local variables with the same name are different variables if they appear in disjoint scopes.

**Method parameters** are considered to be variables local to that method.

**Block parameters** are assigned values when the block is invoked.

```
a = [1, 2, 3]
a.each {|i| puts i } # i local to block
a.each {|$i| puts $i } # assigns to global $i
a.each {|@i| puts @i } # assigns to instance variable @i
a.each {|I| puts I } # generates warning assigning to constant
a.each {|b.meth| } # invokes meth= in object b
sum = 0
var = nil
a.each {|var| sum += var } # uses sum and var from enclosing scope
```

If a local variable (including a block parameter) is first assigned in a block, it is local to the block. If instead a variable of the same name is already established at the time the block executes, the block will inherit that variable.

A block takes on the set of local variables in existence at the time that it is created. This forms part of its binding. Note that although the binding of the variables is fixed at this point, the block will have access to the *current* values of these variables when it executes. The binding preserves these variables even if the original enclosing scope is destroyed.

The bodies of `while`, `until`, and `for` loops are part of the scope that contains them; previously existing locals can be used in the loop, and any new locals created will be available outside the bodies afterward.

## Predefined Variables

The following variables are predefined in the Ruby interpreter. In these descriptions, the notation `[r/o]` indicates that the variables are read-only; an error will be raised if a program attempts to modify a read-only variable. After all, you probably don't want to change the meaning of `true` halfway through your program (except perhaps if you're a politician). Entries marked `[thread]` are thread local.

Many global variables look something like Snoopy swearing: `$_`, `$!`, `$&`, and so on. This is for “historical” reasons, as most of these variable names come from Perl. If you find memorizing all this punctuation difficult, you may want to have a look at the library file called `English`, documented on page 650, which gives the commonly used global variables more descriptive names.

In the tables of variables and constants that follow, we show the variable name, the type of the referenced object, and a description.

## Exception Information

\$!	Exception	The exception object passed to <code>raise</code> . [thread]
\$@	Array	The stack backtrace generated by the last exception. See <code>Kernel#caller</code> on page 497 for details. [thread]

## Pattern Matching Variables

These variables (except `$=`) are set to `nil` after an unsuccessful pattern match.

\$&	String	The string matched (following a successful pattern match). This variable is local to the current scope. [r/o, thread]
\$+	String	The contents of the highest-numbered group matched following a successful pattern match. Thus, in <code>"cat" =~/(c a)(t z)/</code> , <code>\$+</code> will be set to <code>"t"</code> . This variable is local to the current scope. [r/o, thread]
\$`	String	The string preceding the match in a successful pattern match. This variable is local to the current scope. [r/o, thread]
\$'	String	The string following the match in a successful pattern match. This variable is local to the current scope. [r/o, thread]
<u>1.8</u> <code>\$=</code>	Object	Deprecated. If set to any value apart from <code>nil</code> or <code>false</code> , all pattern matches will be case insensitive, string comparisons will ignore case, and string hash values will be case insensitive.
<code>\$1 to \$9</code>	String	The contents of successive groups matched in a successful pattern match. In <code>"cat" =~/(c a)(t z)/</code> , <code>\$1</code> will be set to <code>"a"</code> and <code>\$2</code> to <code>"t"</code> . This variable is local to the current scope. [r/o, thread]
<code>\$~</code>	MatchData	An object that encapsulates the results of a successful pattern match. The variables <code>\$&amp;</code> , <code>\$`</code> , <code>\$'</code> , and <code>\$1 to \$9</code> are all derived from <code>\$~</code> . Assigning to <code>\$~</code> changes the values of these derived variables. This variable is local to the current scope. [thread]

## Input/Output Variables

<code>\$/</code>	String	The input record separator (newline by default). This is the value that routines such as <code>Kernel#gets</code> use to determine record boundaries. If set to <code>nil</code> , <code>gets</code> will read the entire file.
<code>\$-0</code>	String	Synonym for <code>\$/</code> .
<code>\$\</code>	String	The string appended to the output of every call to methods such as <code>Kernel#print</code> and <code>IO#write</code> . The default value is <code>nil</code> .
<code>\$_</code>	String	The separator string output between the parameters to methods such as <code>Kernel#print</code> and <code>Array#join</code> . Defaults to <code>nil</code> , which adds no text.
<code>\$.</code>	Fixnum	The number of the last line read from the current input file.
<code>\$;</code>	String	The default separator pattern used by <code>String#split</code> . May be set from the command line using the <code>-F</code> flag.

	\$<	Object	An object that provides access to the concatenation of the contents of all the files given as command-line arguments or \$stdin (in the case where there are no arguments). \$< supports methods similar to a File object: binmode, close, closed?, each, each_byte, each_line, eof, eof?, file, filename, fileno, getc, gets, lineno, lineno=, path, pos, pos=, read, readchar, readline, readlines, rewind, seek, skip, tell, to_a, to_i, to_io, to_s, along with the methods in Enumerable. The method file returns a File object for the file currently being read. This may change as \$< reads through the files on the command line. [r/o]
	\$>	IO	The destination of output for Kernel#print and Kernel#printf. The default value is \$stdout.
	\$_	String	The last line read by Kernel#gets or Kernel#readline. Many string-related functions in the Kernel module operate on \$_ by default. The variable is local to the current scope. [thread]
<u>1.8</u>	\$defout	IO	Synonym for \$>. Obsolete: use \$stdout.
<u>1.8</u>	\$deferr	IO	Synonym for STDERR. Obsolete: use \$stderr.
	\$_F	String	Synonym for \$;.
	\$stderr	IO	The current standard error output.
	\$stdin	IO	The current standard input.
<u>1.8</u>	\$stdout	IO	The current standard output. Assignment to \$stdout is deprecated: use \$stdout.reopen instead.

## Execution Environment Variables

	\$0	String	The name of the top-level Ruby program being executed. Typically this will be the program's filename. On some operating systems, assigning to this variable will change the name of the process reported (for example) by the ps(1) command.
	\$*	Array	An array of strings containing the command-line options from the invocation of the program. Options used by the Ruby interpreter will have been removed. [r/o]
	\$"	Array	An array containing the filenames of modules loaded by require. [r/o]
	\$\$	Fixnum	The process number of the program being executed. [r/o]
	\$?	Process::Status	The exit status of the last child process to terminate. [r/o, thread]
	\$:	Array	An array of strings, where each string specifies a directory to be searched for Ruby scripts and binary extensions used by the load and require methods. The initial value is the value of the arguments passed via the -I command-line option, followed by an installation-defined standard library location, followed by the current directory (“.”). This variable may be set from within a program to alter the default search path; typically, programs use \$: << dir to append dir to the path. [r/o]
	\$-a	Object	True if the -a option is specified on the command line. [r/o]

<code>\$-d</code>	Object	Synonym for <code>\$DEBUG</code> .
<code>\$DEBUG</code>	Object	Set to <code>true</code> if the <code>-d</code> command-line option is specified.
<code>__FILE__</code>	String	The name of the current source file. [r/o]
<code>\$F</code>	Array	The array that receives the split input line if the <code>-a</code> command-line option is used.
<code>\$FILENAME</code>	String	The name of the current input file. Equivalent to <code>\$&lt;.filename</code> . [r/o]
<code>\$-i</code>	String	If in-place edit mode is enabled (perhaps using the <code>-i</code> command-line option), <code>\$-i</code> holds the extension used when creating the backup file. If you set a value into <code>\$-i</code> , enables in-place edit mode. See page 168.
<code>\$-I</code>	Array	Synonym for <code>\$:</code> . [r/o]
<code>\$-K</code>	String	Sets the multibyte coding system for strings and regular expressions. Equivalent to the <code>-K</code> command-line option. See page 169.
<code>\$-l</code>	Object	Set to <code>true</code> if the <code>-l</code> option (which enables line-end processing) is present on the command line. See page 169. [r/o]
<code>__LINE__</code>	String	The current line number in the source file. [r/o]
<code>\$LOAD_PATH</code>	Array	A synonym for <code>\$:</code> . [r/o]
<code>\$-p</code>	Object	Set to <code>true</code> if the <code>-p</code> option (which puts an implicit <code>while gets ... end</code> loop around your program) is present on the command line. See page 169. [r/o]
<code>\$SAFE</code>	Fixnum	The current safe level (see page 380). This variable's value may never be reduced by assignment. [thread]
<u>1.8</u> <code>\$VERBOSE</code>	Object	Set to <code>true</code> if the <code>-v</code> , <code>--version</code> , <code>-W</code> , or <code>-w</code> option is specified on the command line. Set to <code>false</code> if no option, or <code>-W1</code> is given. Set to <code>nil</code> if <code>-W0</code> was specified. Setting this option to <code>true</code> causes the interpreter and some library routines to report additional information. Setting to <code>nil</code> suppresses all warnings (including the output of <code>Kernel.warn</code> ).
<code>\$-v</code>	Object	Synonym for <code>\$VERBOSE</code> .
<code>\$-w</code>	Object	Synonym for <code>\$VERBOSE</code> .

## Standard Objects

<code>ARGF</code>	Object	A synonym for <code>\$&lt;</code> .
<code>ARGV</code>	Array	A synonym for <code>\$*</code> .
<code>ENV</code>	Object	A hash-like object containing the program's environment variables. An instance of class <code>Object</code> , <code>ENV</code> implements the full set of <code>Hash</code> methods. Used to query and set the value of an environment variable, as in <code>ENV["PATH"]</code> and <code>ENV["term"]="ansi"</code> .
<code>false</code>	<code>FalseClass</code>	Singleton instance of class <code>FalseClass</code> . [r/o]
<code>nil</code>	<code>NilClass</code>	The singleton instance of class <code>NilClass</code> . The value of uninitialized instance and global variables. [r/o]

<code>self</code>	Object	The receiver (object) of the current method. [r/o]
<code>true</code>	TrueClass	Singleton instance of class TrueClass. [r/o]

## Global Constants

The following constants are defined by the Ruby interpreter.

<code>DATA</code>	IO	If the the main program file contains the directive <code>__END__</code> , then the constant <code>DATA</code> will be initialized so that reading from it will return lines following <code>__END__</code> from the source file.
<code>FALSE</code>	FalseClass	Synonym for <code>false</code> .
<code>NIL</code>	NilClass	Synonym for <code>nil</code> .
<code>RUBY_PLATFORM</code>	String	The identifier of the platform running this program. This string is in the same form as the platform identifier used by the GNU configure utility (which is not a coincidence).
<code>RUBY_RELEASE_DATE</code>	String	The date of this release.
<code>RUBY_VERSION</code>	String	The version number of the interpreter.
<code>STDERR</code>	IO	The actual standard error stream for the program. The initial value of <code>\$stderr</code> .
<code>STDIN</code>	IO	The actual standard input stream for the program. The initial value of <code>\$stdin</code> .
<code>STDOUT</code>	IO	The actual standard output stream for the program. The initial value of <code>\$stdout</code> .
<code>SCRIPT_LINES__</code>	Hash	If a constant <code>SCRIPT_LINES__</code> is defined and references a Hash, Ruby will store an entry containing the contents of each file it parses, with the file's name as the key and an array of strings as the value. See <code>Kernel.require</code> on page 507 for an example.
<code>TOPLEVEL_BINDING</code>	Binding	A Binding object representing the binding at Ruby's top level—the level where programs are initially executed.
<code>TRUE</code>	TrueClass	Synonym for <code>true</code> .

The constant `__FILE__` and the variable `$0` are often used together to run code only if it appears in the file run directly by the user. For example, library writers often use this to include tests in their libraries that will be run if the library source is run directly, but not if the source is required into another program.

```
library code
...
if __FILE__ == $0
 # tests...
end
```

# Expressions

Single terms in an expression may be any of the following.

- **Literal.** Ruby literals are numbers, strings, arrays, hashes, ranges, symbols, and regular expressions. There are described starting on page 304.
- **Shell command.** A shell command is a string enclosed in backquotes or in a general delimited string (page 303) starting with %x. The value of the string is the standard output of running the command represented by the string under the host operating system’s standard shell. The execution also sets the \$? variable with the command’s exit status.

```
filter = "*.c"
files = `ls #{filter}`
files = %x{ls #{filter}}
```

1.8

- **Symbol generator.** A Symbol object is created by prefixing an operator, string, variable, constant, method, class, module name with a colon. The symbol object will be unique for each different name but does not refer to a particular instance of the name, so the symbol for (say) :fred will be the same regardless of context. A symbol is similar to the concept of atoms in other high-level languages.
- **Variable reference or constant reference.** A variable is referenced by citing its name. Depending on scope (see page 315), a constant is referenced either by citing its name or by qualifying the name, using the name of the class or module containing the constant and the scope operator (::).

```
barney # variable reference
APP_NAMR # constant reference
Math::PI # qualified constant reference
```

- **Method invocation.** The various ways of invoking a method are described starting on page 333.

## Operator Expressions

Expressions may be combined using operators. Table 22.4 on the next page lists the Ruby operators in precedence order. The operators with a ✓ in the Method column are implemented as methods, and may be overridden.

## More on Assignment

The assignment operator assigns one or more *rvalues* (the *r* stands for “right,” as *rvalues* tend to appear on the right side of assignments) to one or more *lvalues* (“left” values). What is meant by assignment depends on each individual *lvalue*.

Table 22.4. Ruby operators (high to low precedence)

Method	Operator	Description
✓	[ ] [ ]=	Element reference, element set
✓	**	Exponentiation
✓	! ~ + -	Not, complement, unary plus and minus (method names for the last two are +@ and -@)
✓	* / %	Multiply, divide, and modulo
✓	+ -	Plus and minus
✓	>> <<	Right and left shift
✓	&	“And” (bitwise for integers)
✓	^	Exclusive “or” and regular “or” (bitwise for integers)
✓	<= < > >=	Comparison operators
✓	<=> == === != =~ !~	Equality and pattern match operators (!= and !~ may not be defined as methods)
	&&	Logical “and”
		Logical “or”
	.. ...	Range (inclusive and exclusive)
	? :	Ternary if-then-else
	= %= ~= /= -= +=  = &=	Assignment
	>>= <<= *= &&=   = **=	
	defined?	Check if symbol defined
	not	Logical negation
	or and	Logical composition
	if unless while until	Expression modifiers
	begin/end	Block expression

If an lvalue is a variable or constant name, that variable or constant receives a reference to the corresponding rvalue.

```
a = /regexp/
b, c, d = 1, "cat", [3, 4, 5]
```

If the lvalue is an object attribute, the corresponding attribute setting method will be called in the receiver, passing as a parameter the rvalue.

```
obj = A.new
obj.value = "hello" # equivalent to obj.value=("hello")
```

If the lvalue is an array element reference, Ruby calls the element assignment operator ([ ]=) in the receiver, passing as parameters any indices that appear between the brackets followed by the rvalue. This is illustrated in the following table.



Element Reference	Actual Method Call
<code>obj[] = "one"</code>	<code>obj.[]=("one")</code>
<code>obj[1] = "two"</code>	<code>obj.[]=(1, "two")</code>
<code>obj["a", /^cat/] = "three"</code>	<code>obj.[]=("a", /^cat/, "three")</code>

1.8

The value of an assignment expression is its rvalue. This is true even if the assignment is to an attribute method that returns something different.

## Parallel Assignment

An assignment expression may have one or more lvalues and one or more rvalues. This section explains how Ruby handles assignment with different combinations of arguments.

- If the last rvalue is prefixed with an asterisk and implements `to_ary`, the rvalue is replaced with the elements of the array, with each element forming its own rvalue.
- If the assignment contains multiple lvalues and one rvalue, the rvalue is converted into an `Array`, and this array is expanded into a set of rvalues as described in (1).
- Successive rvalues are assigned to the lvalues. This assignment effectively happens in parallel, so that (for example) `a, b=b, a` swaps the values in `a` and `b`.
- If there are more lvalues than rvalues, the excess will have `nil` assigned to them.
- If there are more rvalues than lvalues, the excess will be ignored.
- These rules are modified slightly if the last lvalue is preceded with an asterisk. This lvalue will always receive an array during the assignment. The array will consist of whatever rvalue would normally have been assigned to this lvalue, followed by the excess rvalues (if any).
- If an lvalue contains a parenthesized list, the list is treated as a nested assignment statement, and the it is assigned from the corresponding rvalue as described by these rules.

The tutorial has examples starting on page [85](#).

## Block Expressions

```
begin
 body
end
```

Expressions may be grouped between `begin` and `end`. The value of the block expression is the value of the last expression executed.

Block expressions also play a role in exception handling, which is discussed starting on page [345](#).

## Boolean Expressions

Ruby predefines the globals `false` and `nil`. Both of these values are treated as being false in a boolean context. All other values are treated as being true. The constant `true` is available for when you need an explicit “true” value.

### And, Or, Not, and Defined?

The `and` and `&&` operators evaluate their first operand. If false, the expression returns the value of the first operand; otherwise, the expression returns the value of the second operand.

```
expr1 and expr2
expr1 && expr2
```

The `or` and `||` operators evaluate their first operand. If true, the expression returns the value of their first operand; otherwise, the expression returns the value of the second operand.

```
expr1 or expr2
expr1 || expr2
```

The `not` and `!` operators evaluate their operand. If true, the expression returns false. If false, the expression returns true. For historical reasons, a string, regexp, or range may not appear as the single argument to `not` or `!`.

The word forms of these operators (`and`, `or`, and `not`) have a lower precedence than the corresponding symbol forms (`&&`, `||`, and `!`). See Table 22.4 on page 324 for details.

The `defined?` operator returns `nil` if its argument, which can be an arbitrary expression, is not defined. Otherwise, it returns a description of that argument. For examples, see page 88 in the tutorial.

## Comparison Operators

The Ruby syntax defines the comparison operators `==`, `===`, `<=>`, `<`, `<=`, `>`, `>=`, `=~`. All of these operators are implemented as methods. By convention, the language also uses the standard methods `eq?` and `equal?` (see Table 7.1 on page 89). Although the operators have intuitive meaning, it is up to the classes that implement them to produce meaningful comparison semantics. The library reference starting on page 402 describes the comparison semantics for the built-in classes. The module `Comparable` provides support for implementing the operators `==`, `<`, `<=`, `>`, `>=`, and the method `between?` in terms of `<=>`. The operator `===` is used in case expressions, described on page 328.

Both `==` and `=~` have negated forms, `!=` and `!~`. Ruby converts these during syntax analysis: `a != b` is mapped to `!(a == b)`, and `a !~ b` is mapped to `!(a =~ b)`. No methods correspond to `!=` and `!~`.

Figure 22.1. State transitions for boolean range

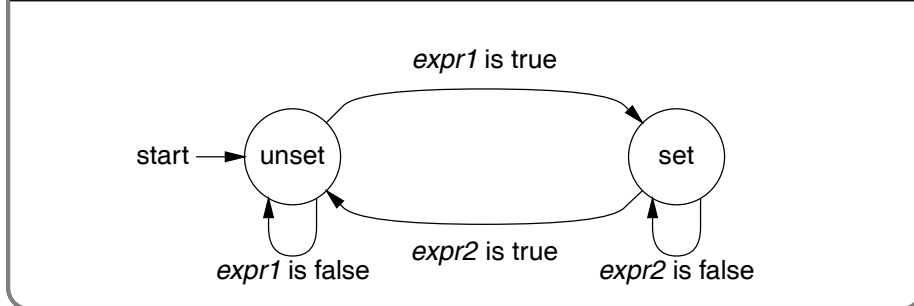

## Ranges in Boolean Expressions

```

if expr1 .. expr2
while expr1 ... expr2

```

A range used in a boolean expression acts as a flip-flop. It has two states, set and unset, and is initially unset. On each call, the range executes a transition in the state machine shown in Figure 22.1. The range expression returns true if the state machine is in the set state at the end of the call, and false otherwise.

The two-dot form of a range behaves slightly differently than the three-dot form. When the two-dot form first makes the transition from unset to set, it immediately evaluates the end condition and makes the transition accordingly. This means that if *expr1* and *expr2* both evaluate to true on the same call, the two-dot form will finish the call in the unset state. However, it still returns true for this call.

The three-dot form does not evaluate the end condition immediately upon entering the set state.

The difference is illustrated by the following code.

```

a = (11..20).collect {|i| (i%4 == 0)..(i%3 == 0) ? i : nil}
a → [nil, 12, nil, nil, nil, 16, 17, 18, nil, 20]

a = (11..20).collect {|i| (i%4 == 0)...(i%3 == 0) ? i : nil}
a → [nil, 12, 13, 14, 15, 16, 17, 18, nil, 20]

```

## Regular Expressions in Boolean Expressions

### 1.8

In versions of Ruby prior to 1.8, a single regular expression in boolean expression was matched against the current value of the variable `$_`. This behavior is now only supported if the condition appears in a command-line `-e` parameter. In regular code, the use of implicit operands and `$_` is being slowly phased out, so it is better to use an explicit match against a variable. If a match against `$_` is required, use

```

if ~/re/ ... or if $_ =~ /re/ ...

```

## if and unless Expressions

```

if boolean-expression [then | :]
 body
[elsif boolean-expression [then | :]
 body , ...]
[else
 body]
end

unless boolean-expression [then | :]
 body
[else
 body]
end

```

The then keyword (or a colon) separates the body from the condition. It is not required if the body starts on a new line. The value of an if or unless expression is the value of the last expression evaluated in whichever body is executed.

## if and unless Modifiers

```

expression if boolean-expression
expression unless boolean-expression

```

evaluates *expression* only if *boolean-expression* is true (for if) or false (for unless).

## Ternary Operator

```

boolean-expression ? expr1 : expr2

```

returns *expr1* if *boolean expression* is true and *expr2* otherwise.

## case Expressions

Ruby has two forms of case statement. The first allows a series of conditions to be evaluated, executing code corresponding to the first condition that is true.

```

case
when condition [, condition].. [then | :]
 body
when condition [, condition].. [then | :]
 body
...
[else
 body]
end

```

The second form of a case expression takes a target expression following the case keyword. It searches for a match by starting at the first (top left) comparison, performing *comparison === target*.

```

case target
when comparison [, comparison]... [then | :]
 body
when comparison [, comparison]... [then | :]
 body
...
[else
 body]
end

```

A comparison can be an array reference preceded by an asterisk, in which case it is expanded into that array's elements before the tests are performed on each. When a comparison returns true, the search stops, and the body associated with the comparison is executed (no `break` is required). `case` then returns the value of the last expression executed. If no *comparison* matches: if an `else` clause is present, its body will be executed; otherwise, `case` silently returns `nil`.

The `then` keyword (or a colon) separates the `when` comparisons from the bodies and is not needed if the body starts on a new line.

## Loops

```

while boolean-expression [do | :]
 body
end

```

executes *body* zero or more times as long as *boolean-expression* is true.

```

until boolean-expression [do | :]
 body
end

```

executes *body* zero or more times as long as *boolean-expression* is false.

In both forms, the `do` or colon separates *boolean-expression* from the *body* and can be omitted when the body starts on a new line.

```

for name [, name]... in expression [do | :]
 body
end

```

The `for` loop is executed as if it were the following each loop, except that local variables defined in the body of the `for` loop will be available outside the loop, and those defined within an iterator block will not.

```

expression.each do | name [, name]... |
 body
end

```

`loop`, which iterates its associated block, is not a language construct—it is a method in module `Kernel`.

*Library*

```

loop do
 print "Input: "
 break unless line = gets
 process(line)
end

```

## while and until Modifiers

```

expression while boolean-expression
expression until boolean-expression

```

If *expression* is anything other than a begin/end block, executes *expression* zero or more times while *boolean-expression* is true (for while) or false (for until).

If *expression* is a begin/end block, the block will always be executed at least one time.

## break, redo, next, and retry

break, redo, next, and retry alter the normal flow through a while, until, for, or iterator controlled loop.

break terminates the immediately enclosing loop—control resumes at the statement following the block. redo repeats the loop from the start, but without reevaluating the condition or fetching the next element (in an iterator). The next keyword skips to the end of the loop, effectively starting the next iteration. retry restarts the loop, reevaluating the condition.

### 1.8

break and next may optionally take one or more arguments. If used within a block, the given argument(s) are returned as the value of the yield. If used within a while, until, or for loop, the value given to break is returned as the value of the statement, and the value given to next is silently ignored. If break is never called, or if it is called with no value, the loop returns nil.

```

match = while line = gets
 next if line =~ /^#/
 break line if line =~ /ruby/
end

match = for line in ARGF.readlines
 next if line =~ /^#/
 break line if line =~ /ruby/
end

```

## Method Definition

```

def defname [([arg [=val], ...] [, *vararg] [, &blockarg])]
 body
end

```

*defname* is both the name of the method and optionally the context in which it is valid.

```

defname ← methodname
 constant.methodname
 (expr).methodname

```

A *methodname* is either a redefinable operator (see Table 22.4 on page 324) or a name. If *methodname* is a name, it should start with a lowercase letter (or underscore) optionally followed by upper- and lowercase letters, underscores, and digits. A *methodname* may optionally end with a question mark (?), exclamation point (!), or equals sign (=). The question mark and exclamation point are simply part of the name. The equals sign is also part of the name but additionally signals that this method may be used as an lvalue (described on page 29).

A method definition using an unadorned method name within a class or module definition creates an instance method. An instance method may be invoked only by sending its name to a receiver that is an instance of the class that defined it (or one of that class's subclasses).

Outside a class or module definition, a definition with an unadorned method name is added as a private method to class Object, and hence may be called in any context without an explicit receiver.

A definition using a method name of the form *constant.methodname* or the more general *(expr).methodname* creates a method associated with the object that is the value of the constant or expression; the method will be callable only by supplying the object referenced by the expression as a receiver. This style of definition creates per object or *singleton methods*.

```

class MyClass
 def MyClass.method # definition
 end
end
MyClass.method # call
obj = Object.new
def obj.method # definition
end
obj.method # call
def (1.class).fred # receiver may be an expression
end
Fixnum.fred # call

```

### 1.8

Method definitions may not contain class or module definitions. They may contain nested instance or singleton method definitions. The internal method is defined when the enclosing method is executed. The internal method does *not* act as a closure in the context of the nested method—it is self contained.

```

def toggle
 def toggle
 "subsequent times"
 end
 "first time"
end

toggle → "first time"
toggle → "subsequent times"
toggle → "subsequent times"

```

The body of a method acts as if it were a `begin/end` block, in that it may contain exception handling statements (`rescue`, `else`, and `ensure`).

## Method Arguments

A method definition may have zero or more regular arguments, an optional array argument, and an optional block argument. Arguments are separated by commas, and the argument list may be enclosed in parentheses.

A regular argument is a local variable name, optionally followed by an equals sign and an expression giving a default value. The expression is evaluated at the time the method is called. The expressions are evaluated from left to right. An expression may reference a parameter that precedes it in the argument list.

```

def options(a=99, b=a+1)
 [a, b]
end

options → [99, 100]
options 1 → [1, 2]
options 2, 4 → [2, 4]

```

The optional array argument must follow any regular arguments and may not have a default. When the method is invoked, Ruby sets the array argument to reference a new object of class `Array`. If the method call specifies any parameters in excess of the regular argument count, all these extra parameters will be collected into this newly created array.

```

def varargs(a, *b)
 [a, b]
end

varargs 1 → [1, []]
varargs 1, 2 → [1, [2]]
varargs 1, 2, 3 → [1, [2, 3]]

```

If an array argument follows arguments with default values, parameters will first be used to override the defaults. The remainder will then be used to populate the array.



```

def mixed(a, b=99, *c)
 [a, b, c]
end
mixed 1 → [1, 99, []]
mixed 1, 2 → [1, 2, []]
mixed 1, 2, 3 → [1, 2, [3]]
mixed 1, 2, 3, 4 → [1, 2, [3, 4]]

```

The optional block argument must be the last in the list. Whenever the method is called, Ruby checks for an associated block. If a block is present, it is converted to an object of class Proc and assigned to the block argument. If no block is present, the argument is set to nil.

```

def example(&block)
 puts block.inspect
end
example
example { "a block" }

```

*produces:*

```

nil
#<Proc:0x001c9940@-:6>

```

## Invoking a Method

```

[receiver.] name [parameters] [block]
[receiver::] name [parameters] [block]

parameters ← ([param, ...] [, hashlist] [*array] [&a_proc])

block ← { blockbody }
 do blockbody end

```

Initial parameters are assigned to the actual arguments of the method. Following these parameters may be a list of *key => value* pairs. These pairs are collected into a single new Hash object and passed as a single parameter.

Following these parameters may be a single parameter prefixed with an asterisk. If this parameter is an array, Ruby replaces it with zero or more parameters corresponding to the elements of the array.

```

def regular(a, b, *c)
 # ..
end
regular 1, 2, 3, 4
regular(1, 2, 3, 4)
regular(1, *[2, 3, 4])

```

A block may be associated with a method call using either a literal block (which must start on the same source line as the last line of the method call) or a parameter containing a reference to a Proc or Method object prefixed with an ampersand character. Regardless of the presence of a block argument, Ruby arranges for the value of the global function `Kernel.block_given?` to reflect the availability of a block associated with the call.

```
a_proc = lambda { 99 }
an_array = [98, 97, 96]
def block
 yield
end
block { }
block do
 end
block(&a_proc)
def all(a, b, c, *d, &e)
 puts "a = #{a.inspect}"
 puts "b = #{b.inspect}"
 puts "c = #{c.inspect}"
 puts "d = #{d.inspect}"
 puts "block = #{yield(e).inspect}"
end
all('test', 1 => 'cat', 2 => 'dog', *an_array, &a_proc)
```

*produces:*

```
a = "test"
b = {1=>"cat", 2=>"dog"}
c = 98
d = [97, 96]
block = 99
```

A method is called by passing its name to a receiver. If no receiver is specified, `self` is assumed. The receiver checks for the method definition in its own class and then sequentially in its ancestor classes. The instance methods of included modules act as if they were in anonymous superclasses of the class that includes them. If the method is not found, Ruby invokes the method `method_missing` in the receiver. The default behavior defined in `Kernel.method_missing` is to report an error and terminate the program.

*Library*

When a receiver is explicitly specified in a method invocation, it may be separated from the method name using either a period “.” or two colons “:”. The only difference between these two forms occurs if the method name starts with an uppercase letter. In this case, Ruby will assume that a `receiver::Thing` method call is actually an attempt to access a constant called `Thing` in the receiver *unless* the method invocation has a parameter list between parentheses.

```

Foo.Bar() # method call
Foo.Bar # method call
Foo::Bar() # method call
Foo::Bar # constant access

```

The return value of a method is the value of the last expression executed.

```
return [expr, ...]
```

A return expression immediately exits a method. The value of a return is `nil` if it is called with no parameters, the value of its parameter if it is called with one parameter, or an array containing all of its parameters if it is called with more than one parameter.

## super

```
super [([param, ...] [*array])] [block]
```

Within the body of a method, a call to `super` acts just like a call to that original method, except that the search for a method body starts in the superclass of the object that was found to contain the original method. If no parameters (and no parentheses) are passed to `super`, the original method's parameters will be passed; otherwise, the parameters to `super` will be passed.

## Operator Methods

```

expr1 operator
operator expr1
expr1 operator expr2

```

If the operator in an operator expression corresponds to a redefinable method (see the Table 22.4 on page 324), Ruby will execute the operator expression as if it had been written

```
(expr1).operator(expr2)
```

## Attribute Assignment

```
receiver.attrname = rvalue
```

1.8

When the form `receiver.attrname` appears as an lvalue, Ruby invokes a method named `attrname=` in the receiver, passing `rvalue` as a single parameter. The value returned by this assignment is always `rvalue`—the return value of the method `attrname=` is discarded. If you want to access the return value (in the unlikely event that it isn't the `rvalue` anyway), send an explicit message to the method.

```

class Demo
 attr_reader :attr
 def attr=(val)
 @attr = val
 "return value"
 end
end

d = Demo.new

In all these cases, @attr is set to 99
d.attr = 99 → 99
d.attr=(99) → 99
d.send(:attr=, 99) → "return value"
d.attr → 99

```

## Element Reference Operator

```

receiver[expr [, expr]...]
receiver[expr [, expr]...] = rvalue

```

When used as an rvalue, element reference invokes the method `[ ]` in the receiver, passing as parameters the expressions between the brackets.

When used as an lvalue, element reference invokes the method `[ ]=` in the receiver, passing as parameters the expressions between the brackets, followed by the *rvalue* being assigned.

## Aliasing

```
alias new_name old_name
```

creates a new name that refers to an existing method, operator, global variable, or regular expression backreference (`$&`, `$``, `$'`, and `$+`). Local variables, instance variables, class variables, and constants may not be aliased. The parameters to `alias` may be names or symbols.

```

class Fixnum
 alias plus +
end
1.plus(3) → 4

alias $prematch `$
"string" =~ /i/ → 3
$prematch → "str"

alias :cmd :`
cmd "date" → "Tue Oct 26 11:32:20 CDT 2004\n"

```

When a method is aliased, the new name refers to a copy of the original method's body. If the method is subsequently redefined, the aliased name will still invoke the original implementation.

```
def meth
 "original method"
end
alias original meth
def meth
 "new and improved"
end
meth → "new and improved"
original → "original method"
```

## Class Definition

```
class [scope::] classname [< superexpr]
 body
end

class << obj
 body
end
```

A Ruby class definition creates or extends an object of class `Class` by executing the code in *body*. In the first form, a named class is created or extended. The resulting `Class` object is assigned to a constant named *classname* (see below for scoping rules). This name should start with an uppercase letter. In the second form, an anonymous (singleton) class is associated with the specific object.

If present, *superexpr* should be an expression that evaluates to a `Class` object that will be the superclass of the class being defined. If omitted, it defaults to `class Object`.

Within *body*, most Ruby expressions are executed as the definition is read. However:

- Method definitions will register the methods in a table in the class object.
- Nested class and module definitions will be stored in constants within the class, not as global constants. These nested classes and modules can be accessed from outside the defining class using “:” to qualify their names.

```
module NameSpace
 class Example
 CONST = 123
 end
end
obj = NameSpace::Example.new
a = NameSpace::Example::CONST
```

- The `Module#include` method will add the named modules as anonymous superclasses of the class being defined.

1.8

The *classname* in a class definition may be prefixed by the names of existing classes or modules using the scope operator (`::`). This syntax inserts the new definition into the namespace of the prefixing module(s) and/or class(es) but does not interpret the definition in the scope of these outer classes. A *classname* with a leading scope operator places that class or module in the top-level scope.

In the following example, class `C` is inserted into module `A`'s namespace but is not interpreted in the context of `A`. As a result, the reference to `CONST` resolves to the top-level constant of that name, not `A`'s version. We also have to fully qualify the singleton method name, as `C` on its own is not a known constant in the context of `A::C`.

```
CONST = "outer"

module A
 CONST = "inner" # This is A::CONST
end

module A
 class B
 def B.get_const
 CONST
 end
 end
end

A::B.get_const → "inner"

class A::C
 def (A::C).get_const
 CONST
 end
end

A::C.get_const → "outer"
```

It is worth emphasizing that a class definition is executable code. Many of the directives used in class definition (such as `attr` and `include`) are actually simply private instance methods of class `Module` (documented starting on page 533).

Chapter 24, which begins on page 362, describes in more detail how Class objects interact with the rest of the environment.

## Creating Objects from Classes

```
obj = classexpr.new [([args, ...])]
```

1.8

Class `Class` defines the instance method `Class#new`, which creates an object of the class of the receiver (*classexpr* in the syntax example). This is done by calling the method *classexpr.allocate*. You can override this method, but your implementation must return an object of the correct class. It then invokes `initialize` in the newly created object, and passes it any arguments originally passed to `new`.

If a class definition overrides the class method `new` without calling `super`, no objects of that class can be created, and calls to `new` will silently return `nil`.

Like any other method, `initialize` should call `super` if it wants to ensure that parent classes have been properly initialized. This is not necessary when the parent is `Object`, as class `Object` does no instance-specific initialization.

## Class Attribute Declarations

Class attribute declarations are not part of the Ruby syntax: they are simply methods defined in class `Module` that create accessor methods automatically.

*Library*

```
class name
 attr attribute [, writable]
 attr_reader attribute [, attribute]...
 attr_writer attribute [, attribute]...
 attr_accessor attribute [, attribute]...
end
```

## Module Definitions

```
module name
 body
end
```

A module is basically a class that cannot be instantiated. Like a class, its body is executed during definition and the resulting `Module` object is stored in a constant. A module may contain class and instance methods and may define constants and class variables. As with classes, module methods are invoked using the `Module` object as a receiver, and constants are accessed using the “`::`” scope resolution operator. The name in a module definition may optionally be preceded by the names of enclosing class(es) and/or module(s).

```
CONST = "outer"
module Mod
 CONST = 1
 def Mod.method1 # module method
 CONST + 1
 end
end
module Mod::Inner
 def (Mod::Inner).method2
 CONST + " scope"
 end
end

Mod::CONST → 1
Mod.method1 → 2
Mod::Inner::method2 → "outer scope"
```

## Mixins—Including Modules

```
class|module name
 include expr
end
```

A module may be included within the definition of another module or class using the `include` method. The module or class definition containing the `include` gains access to the constants, class variables, and instance methods of the module it includes.

*Library*

If a module is included within a class definition, the module’s constants, class variables, and instance methods are effectively bundled into an anonymous (and inaccessible) superclass for that class. Objects of the class will respond to messages sent to the module’s instance methods. Calls to methods not defined in the class will be passed to the module(s) mixed into the class before being passed to any parent class. A module may choose to define an `initialize` method, which will be called upon the creation of an object of a class that mixes in the module if either: (a) the class does not define its own `initialize` method, or (b) the class’s `initialize` method invokes `super`.

A module may also be included at the top level, in which case the module’s constants, class variables, and instance methods become available at the top level.

## Module Functions

Although `include` is useful for providing mixin functionality, it is also a way of bringing the constants, class variables, and instance methods of a module into another namespace. However, functionality defined in an instance method will not be available as a module method.

```
module Math
 def sin(x)
 #
 end
end
Only way to access Math.sin is...
include Math
sin(1)
```

The method `Module#module_function` solves this problem by taking one or more module instance methods and copying their definitions into corresponding module methods.

*Library*

```
module Math
 def sin(x)
 #
 end
 module_function :sin
end
Math.sin(1)
include Math
sin(1)
```



The instance method and module method are two different methods: the method definition is copied by `module_function`, not aliased.

## Access Control

Ruby defines three levels of protection for module and class constants and methods:

- **Public.** Accessible to anyone.
- **Protected.** Can be invoked only by objects of the defining class and its subclasses.
- **Private.** Can be called only in functional form (that is, with an implicit `self` as the receiver). Private methods therefore can be called only in the defining class and by direct descendents within the same object. See discussion starting on page 35 for examples.

```
private [symbol, ...]
protected [symbol, ...]
public [symbol, ...]
```

Each function can be used in two different ways.

*Library*

1. If used with no arguments, the three functions set the default access control of subsequently defined methods.
2. With arguments, the functions set the access control of the named methods and constants.

Access control is enforced when a method is invoked.

## Blocks, Closures, and Proc Objects

A code block is a set of Ruby statements and expressions between braces or a `do/end` pair. The block may start with an argument list between vertical bars. A code block may appear only immediately after a method invocation. The start of the block (the brace or the `do`) must be on the same logical line as the end of the invocation.

```
invocation do | a1, a2, ... |
end

invocation { | a1, a2, ... |
}
```

Braces have a high precedence; `do` has a low precedence. If the method invocation has parameters that are not enclosed in parentheses, the brace form of a block will bind to the last parameter, not to the overall invocation. The `do` form will bind to the invocation.

1.8 Within the body of the invoked method, the code block may be called using the `yield` keyword. Parameters passed to the `yield` will be assigned to arguments in the block. A warning will be generated if `yield` passes multiple parameters to a block that takes just one. The return value of the `yield` is the value of the last expression evaluated in the block or the value passed to a `next` statement executed in the block.

1.8

A block is a *closure*; it remembers the context in which it was defined, and it uses that context whenever it is called. The context includes the value of *self*, the constants, class variables, local variables, and any captured block.

```
class Holder
 CONST = 100
 def call_block
 a = 101
 @a = 102
 @@a = 103
 yield
 end
end

class Creator
 CONST = 0
 def create_block
 a = 1
 @a = 2
 @@a = 3
 proc do
 puts "a = #{a}"
 puts "@a = #@a"
 puts "@@a = #@@a"
 puts yield
 end
 end
end

block = Creator.new.create_block { "original" }
Holder.new.call_block(&block)
```

*produces:*

```
a = 1
@a = 2
@@a = 3
original
```

## Proc Objects, `break`, and `next`

Ruby's blocks are chunks of code attached to a method that operate in the context of the caller. Blocks are not objects, but they can be converted into objects of class `Proc`. There are three ways of converting a block into a `Proc` object.

1. By passing a block to a method whose last parameter is prefixed with an ampersand. That parameter will receive the block as a Proc object.

```
def meth1(p1, p2, &block)
 puts block.inspect
end
meth1(1,2) { "a block" }
meth1(3,4)
```

*produces:*

```
#<Proc:0x001c9940@-:4>
nil
```

2. By calling Proc.new, again associating it with a block.

*Library*

```
block = Proc.new { "a block" }
block → #<Proc:0x001c9ae4@-:1>
```

3. By calling the method Kernel.lambda (or the equivalent, if mildly deprecated, method Kernel.proc), associating a block with the call.

*Library*

```
block = lambda { "a block" }
block → #<Proc:0x001c9b0c@-:1>
```

1.8

The first two styles of Proc object are identical in use. We'll call these objects *raw procs*. The third style, generated by lambda, adds some additional functionality to the Proc object, as we'll see in a minute. We'll call these objects *lambdas*.

Within either kind of block, executing next causes the block to exit. The value of the block is the value (or values) passed to next, or it's nil if no values are passed.

```
def meth
 res = yield
 "The block returns #{res}"
end

meth { next 99 } → "The block returns 99"

pr = Proc.new { next 99 }
pr.call → 99

pr = lambda { next 99 }
pr.call → 99
```

Within a raw proc, a break terminates the method that invoked the block. The return value of the method is any parameters passed to the break.

## Return and Blocks

A return from inside a *block* that's still in scope acts as a return from that scope. A return from a block whose original context is no longer valid raises an exception

(`LocalJumpError` or `ThreadError` depending on the context). The following example illustrates the first case.

```
def meth1
 (1..10).each do |val|
 return val # returns from method
 end
end
meth1 → 1
```

This example shows a return failing because the context of its block no longer exists.

```
def meth2(&b)
 b
end
res = meth2 { return }
res.call
```

*produces:*

```
prog.rb:5: unexpected return (LocalJumpError)
from prog.rb:5:in `call'
from prog.rb:6
```

And here's a return failing because the block is created in one thread and called in another.

```
def meth3
 yield
end
t = Thread.new do
 meth3 { return }
end
t.join
```

*produces:*

```
prog.rb:6: return can't jump across threads (ThreadError)
from prog.rb:9:in `join'
from prog.rb:9
```

The situation with Proc objects is slightly more complicated. If you use `Proc.new` to create a proc from a block, that proc acts like a block, and the previous rules apply.

```
def meth4
 p = Proc.new { return 99 }
 p.call
 puts "Never get here"
end

meth4 → 99
```

If the `Proc` object is created using `Kernel.proc` or `Kernel.lambda`, it behaves more like a free-standing method body: a `return` simply returns from the block to the caller of the block.

```
def meth5
 p = lambda { return 99 }
 res = p.call
 "The block returned #{res}"
end

meth5 → "The block returned 99"
```

Because of this, if you use `Module#define_method`, you'll probably want to pass it a proc created using `lambda`, not `Proc.new`, as `return` will work as expected in the former and will generate a `LocalJumpError` in the latter.

## Exceptions

Ruby exceptions are objects of class `Exception` and its descendents (a full list of the built-in exceptions is given in Figure 27.1 on page 441).

### Raising Exceptions

The `Kernel.raise` method raises an exception.

*Library*

```
raise
raise string
raise thing [, string [stack trace]]
```

The first form reraises the exception in `#!` or a new `RuntimeError` if `#!` is `nil`.

The second form creates a new `RuntimeError` exception, setting its message to the given string.

The third form creates an exception object by invoking the method `exception` on its first argument. It then sets this exception's message and backtrace to its second and third arguments.

Class `Exception` and objects of class `Exception` contain a factory method called `exception`, so an exception class name or instance can be used as the first parameter to `raise`.

When an exception is raised, Ruby places a reference to the `Exception` object in the global variable `#!`.

## Handling Exceptions

Exceptions may be handled

- within the scope of a begin/end block,

```
begin
 code...
 code...
[rescue [parm, ...] [=> var] [then]
 error handling code... , ...]
[else
 no exception code...]
[ensure
 always executed code...]
end
```

- within the body of a method,

```
def method and args
 code...
 code...
[rescue [parm, ...] [=> var] [then]
 error handling code... , ...]
[else
 no exception code...]
[ensure
 always executed code...]
end
```

1.8

- and after the execution of a single statement.

```
statement [rescue statement, ...]
```

A block or method may have multiple rescue clauses, and each rescue clause may specify zero or more exception parameters. A rescue clause with no parameter is treated as if it had a parameter of `StandardError`. This means that some lower-level exceptions will not be caught by a parameterless rescue class. If you want to rescue every exception, use

```
rescue Exception => e
```

1.8

When an exception is raised, Ruby scans up the call stack until it finds an enclosing begin/end block, method body, or statement with a rescue modifier. For each rescue clause in that block, Ruby compares the raised exception against each of the rescue clause's parameters in turn; each parameter is tested using `parameter===$!`. If the raised exception matches a rescue parameter, Ruby executes the body of the rescue and stops looking. If a matching rescue clause ends with `=>` and a variable name, the variable is set to `$!`.

Although the parameters to the `rescue` clause are typically the names of `Exception` classes, they can actually be arbitrary expressions (including method calls) that return an appropriate class.

If no `rescue` clause matches the raised exception, Ruby moves up the stack looking for a higher-level `begin/end` block that matches. If an exception propagates to the top level of the main thread without being rescued, the program terminates with a message.

If an `else` clause is present, its body is executed if no exceptions were raised in *code*. Exceptions raised during the execution of the `else` clause are not captured by `rescue` clauses in the same block as the `else`.

If an `ensure` clause is present, its body is always executed as the block is exited (even if an uncaught exception is in the process of being propagated).

Within a `rescue` clause, `raise` with no parameters will reraise the exception in `#!`.

## Rescue Statement Modifier

A statement may have an optional `rescue` modifier followed by another statement (and by extension another `rescue` modifier, and so on). The `rescue` modifier takes no exception parameter and rescues `StandardError` and its children.

If an exception is raised to the left of a `rescue` modifier, the statement on the left is abandoned, and the value of the overall line is the value of the statement on the right.

```
values = ["1", "2.3", /pattern/]

result = values.map {|v| Integer(v) rescue Float(v) rescue String(v) }

result → [1, 2.3, "(?-mix:pattern)"]
```

## Retrying a Block

The `retry` statement can be used within a `rescue` clause to restart the enclosing `begin/end` block from the beginning.

# Catch and Throw

The method `Kernel.catch` executes its associated block.

*Library*

```
catch (symbol | string) do
 block...
end
```

The method `Kernel.throw` interrupts the normal processing of statements.

*Library*

```
throw(symbol | string [, obj])
```

When a `throw` is executed, Ruby searches up the call stack for the first `catch` block with a matching symbol or string. If it is found, the search stops, and execution resumes past the end of the `catch`'s block. If the `throw` was passed a second parameter, that value is returned as the value of the `catch`. Ruby honors the `ensure` clauses of any block expressions it traverses while looking for a corresponding `catch`.

If no `catch` block matches the `throw`, Ruby raises a `NameError` exception at the location of the `throw`.



# Duck Typing

---

You'll have noticed that in Ruby we don't declare the types of variables or methods—everything is just some kind of object.

Now, it seems like folks react to this in two ways. Some like this kind of flexibility and feel comfortable writing code with dynamically typed variables and methods. If you're one of those people, you might want to skip to the section called “Classes Aren't Types” on the following page. Some, though, get nervous when they think about all those objects floating around unconstrained. If you've come to Ruby from a language such as C# or Java, where you're used to giving all your variables and methods a type, you may feel that Ruby is just too sloppy to use to write “real” applications.

It isn't.

We'd like to spend a couple of paragraphs trying to convince you that the lack of static typing is not a problem when it comes to writing reliable applications. We're not trying to criticize other languages here. Instead, we'd just like to contrast approaches.

The reality is that the static type systems in most mainstream languages don't really help that much in terms of program security. If Java's type system were reliable, for example, it wouldn't need to implement `ClassNotFoundException`. The exception is necessary, though, because there is runtime type uncertainty in Java (as there is in C++, C#, and others). Static typing can be good for optimizing code, and it can help IDEs do clever things with tooltip help, but we haven't seen much evidence that it promotes more reliable code.

On the other hand, once you use Ruby for a while, you realize that dynamically typed variables actually add to your productivity in many ways. You'll also be surprised to discover that your fears about the type chaos were unfounded. Large, long-running, Ruby programs run significant applications and just don't throw any type-related errors. Why is this?

Partly, it's a question of common sense. If you coded in Java (pre Java 1.5), all your containers were effectively untyped: everything in a container was just an `Object`, and

you cast it to the required type when you extracted an element. And yet you probably never saw a `ClassCastException` when you ran these programs. The structure of the code just didn't permit it: you put `Person` objects in, and you later took `Person` objects out. You just don't write programs that would work in another way.

Well, it's the same in Ruby. If you use a variable for some purpose, the chances are very good that you'll be using it for the same purpose when you access it again three lines later. The kind of chaos that *could* happen just doesn't happen.

On top of that, folks who code Ruby a lot tend to adopt a certain style of coding. They write lots of short methods and tend to test as they go along. The short methods mean that the scope of most variables is limited: there just isn't that much time for things to go wrong with their type. And the testing catches the silly errors when they happen: typos and the like just don't get a chance to propagate through the code.

The upshot is that the “safety” in “type safety” is often illusory and that coding in a more dynamic language such as Ruby is both safe and productive. So, if you're nervous about the lack of static typing in Ruby, we suggest you try to put those concerns on the back burner for a little while, and give Ruby a try. We think you'll be surprised at how rarely you see errors because of type issues, and at how much more productive you feel once you start to exploit the power of dynamic typing.

## Classes Aren't Types

The issue of types is actually somewhat deeper than an ongoing debate between strong typing advocates and the hippie-freak dynamic typing crowd. The real issue is the question, what is a type in the first place?

If you've been coding in conventional typed languages, you've probably been taught that the *type* of an object is its *class*—all objects are instances of some class, and that class is the object's type. The class defines the operations (methods) that the object can support, along with the state (instance variables) on which those methods operate. Let's look at some Java code.

```
Customer c;
c = database.findCustomer("dave"); /* Java */
```

This fragment declares the variable `c` to be of type `Customer` and sets it to reference the customer object for Dave that we've created from some database record. So the type of the object in `c` is `Customer`, right?

Maybe. However, even in Java, the issue is slightly deeper. Java supports the concept of *interfaces*, which are a kind of emasculated abstract base class. A Java class can be declared as implementing multiple interfaces. Using this facility, you may have defined your classes as follows.

```

public interface Customer {
 long getID();
 Calendar getDateOfLastContact();
 // ...
}
public class Person
 implements Customer {
 public long getID() { ... }
 public Calendar getDateOfLastContact() { ... }
 // ...
}

```

So even in Java, the class is not always the type—sometimes the type is a subset of the class, and sometimes objects implement multiple types.

In Ruby, the class is never (OK, almost never) the type. Instead, the type of an object is defined more by what that object can do. In Ruby, we call this *duck typing*. If an object walks like a duck and talks like a duck, then the interpreter is happy to treat it as if it were a duck.

Let's look at an example. Perhaps we've written a method to write our customer's name to the end of an open file.

```

class Customer
 def initialize(first_name, last_name)
 @first_name = first_name
 @last_name = last_name
 end
 def append_name_to_file(file)
 file << @first_name << " " << @last_name
 end
end

```

Being good programmers, we'll write a unit test for this. Be warned, though—it's messy (and we'll improve on it shortly).

```

require 'test/unit'
require 'addcust'
class TestAddCustomer < Test::Unit::TestCase
 def test_add
 c = Customer.new("Ima", "Customer")
 f = File.open("tmpfile", "w") do |f|
 c.append_name_to_file(f)
 end
 f = File.open("tmpfile") do |f|
 assert_equal("Ima Customer", f.gets)
 end
 ensure
 File.delete("tmpfile") if File.exist?("tmpfile")
 end
end

```

*produces:*

```
Finished in 0.003207 seconds.
1 tests, 1 assertions, 0 failures, 0 errors
```

We have to do all that work to create a file to write to, then reopen it, and read in the contents to verify the correct string was written. We also have to delete the file when we've finished (but only if it exists).

Instead, though, we could rely on duck typing. All we need is something that walks like a file and talks like a file that we can pass in to the method under test. And all that means *in this circumstance* is that we need an object that responds to the << method by appending something. Do we have something that does this? How about a humble String?

```
require 'test/unit'
require 'addcust'
class TestAddCustomer < Test::Unit::TestCase
 def test_add
 c = Customer.new("Ima", "Customer")
 f = ""
 c.append_name_to_file(f)
 assert_equal("Ima Customer", f)
 end
end
```

*produces:*

```
Finished in 0.001383 seconds.
1 tests, 1 assertions, 0 failures, 0 errors
```

The method under test thinks it's writing to a file, but instead it's just appending to a string. At the end, we can then just test that the content is correct.

We didn't have to use a string—for the object we're testing here, an array would work just as well.

```
require 'test/unit'
require 'addcust'
class TestAddCustomer < Test::Unit::TestCase
 def test_add
 c = Customer.new("Ima", "Customer")
 f = []
 c.append_name_to_file(f)
 assert_equal(["Ima", " ", "Customer"], f)
 end
end
```

*produces:*

```
Finished in 0.001548 seconds.
1 tests, 1 assertions, 0 failures, 0 errors
```

Indeed, this form may be more convenient if we wanted to check that the correct individual things were inserted.

So duck typing is convenient for testing, but what about in the body of applications themselves? Well, it turns out that the same thing that made the tests easy in the previous example also makes it easy to write flexible application code.

If fact, Dave had an interesting experience where duck typing dug him (and a client) out of a hole. He'd written a large Ruby-based Web application that (among other things) kept a database table full of details of participants in a competition. The system provided a comma-separated value (CSV) download capability, allowing administrators to import this information into their local spreadsheets.

Just before competition time, the phone starts ringing. The download, which had been working fine up to this point, was now taking so long that requests were timing out. The pressure was intense, as the administrators had to use this information to build schedules and send out mailings.

A little experimentation showed that the problem was in the routine that took the results of the database query and generated the CSV download. The code looked something like

```
def csv_from_row(op, row)
 res = ""
 until row.empty?
 entry = row.shift.to_s
 if /[,"]/ =~ entry
 entry = entry.gsub(/"/, '""')
 res << '"' << entry << '"'
 else
 res << entry
 end
 res << "," unless row.empty?
 end
 op << res << CRLF
end

result = ""
query.each_row {|row| csv_from_row(result, row)}
http.write result
```

When this code ran against moderate-size data sets, it performed fine. But at a certain input size, it suddenly slowed right down. The culprit? Garbage collection. The approach was generating thousands of intermediate strings and building one big result string, one line at a time. As the big string grew, it needed more space, and garbage collection was invoked, which necessitated scanning and removing all the intermediate strings.

The answer was simple and surprisingly effective. Rather than build the result string as it went along, the code was changed to store each CSV row as an element in an

array. This meant that the intermediate lines were still referenced and hence were no longer garbage. It also meant that we were no longer building an ever-growing string that forced garbage collection. Thanks to duck typing, the change was trivial.

```
def csv_from_row(op, row)
 # as before
end
result = []
query.each_row {|row| csv_from_row(result, row)}
http.write result.join
```

All that changed is that we passed an array into the `csv_from_row` method. Because it (implicitly) used duck typing, the method itself was not modified: it continued to append the data it generated to its parameter, not caring what type that parameter was. After the method returned its result, we joined all those individual lines into one big string. This one change reduced the time to run from more than 3 minutes to a few seconds.

## Coding like a Duck

1.8

If you want to write your programs using the duck typing philosophy, you really only need to remember one thing: an object's type is determined by what it can do, not by its class. (In fact, Ruby 1.8 now deprecates the method `Object#type` in favor of `Object#class` for just this reason: the method returns the class of the receiver, so the name `type` was misleading.)

What does this mean in practice? At one level, it simply means that there's often little value testing the class of an object.

For example, you may be writing a routine to add song information to a string. If you come from a C# or Java background, you may be tempted to write:

```
def append_song(result, song)
 # test we're given the right parameters
 unless result.kind_of?(String)
 fail TypeError.new("String expected")
 end
 unless song.kind_of?(Song)
 fail TypeError.new("Song expected")
 end

 result << song.title << " (" << song.artist << ")"
end

result = ""
append_song(result, song) → "I Got Rhythm (Gene Kelly)"
```

Embrace Ruby's duck typing and you'd write something far simpler.

```
def append_song(result, song)
 result << song.title << " (" << song.artist << ")"
end

result = ""
append_song(result, song) → "I Got Rhythm (Gene Kelly)"
```

You don't need to check the type of the arguments. If they support `<<` (in the case of *result*) or `title` and `artist` (in the case of *song*), everything will just work. If they don't, your method will throw an exception anyway (just as it would have done if you'd checked the types). But without the check, your method is suddenly a lot more flexible: you could pass it an array, a string, a file, or any other object that appends using `<<`, and it would just work.

Now sometimes you may want more than this style of *laissez-faire* programming. You may have good reasons to check that a parameter can do what you need. Will you get thrown out of the duck typing club if you check the parameter against a class? No, you won't.<sup>1</sup> But you may want to consider checking based on the object's capabilities, rather than its class.

```
def append_song(result, song)
 # test we're given the right parameters
 unless result.respond_to?(:<<)
 fail TypeError.new("'result' needs '<<' capability")
 end
 unless song.respond_to?(:artist) && song.respond_to?(:title)
 fail TypeError.new("'song' needs 'artist' and 'title'")
 end

 result << song.title << " (" << song.artist << ")"
end

result = ""
append_song(result, song) → "I Got Rhythm (Gene Kelly)"
```

However, before going down this path, make sure you're getting a real benefit—it's a lot of extra code to write and to maintain.

## Standard Protocols and Coercions

Although not technically part of the language, the interpreter and standard library use various protocols to handle issues that other languages would deal with using types.

Some objects have more than one natural representation. For example, you may be writing a class to represent Roman numbers (I, II, III, IV, V, and so on). This class

---

1. The duck typing club doesn't check to see if you're a member anyway...

is not necessarily a subclass of `Integer`, because its objects are representations of numbers, not numbers in their own right. At the same time they do have an integer-like quality. It would be nice to be able to use objects of our Roman number class wherever Ruby was expecting to see an integer.

To do this, Ruby has the concept of *conversion protocols*—an object may elect to have itself converted to an object of another class. Ruby has three standard ways of doing this.

We've already come across the first. Methods such as `to_s` and `to_i` convert their receiver into strings and integers. These conversion methods are not particularly strict: if an object has some kind of decent representation as a string, for example, it will probably have a `to_s` method. Our Roman class would probably implement `to_s` in order to return the string representation of a number (VII, for instance).

The second form of conversion function uses methods with names such as `to_str` and `to_int`. These are strict conversion functions: you implement them only if your object can naturally be used every place a string or an integer could be used. For example, our Roman number objects have a clear representation as an integer and so should implement `to_int`. When it comes to stringiness, however, we have to think a bit harder.

Roman numbers clearly have a string representation, but are they strings? Should we be able to use them wherever we can use a string itself? No, probably not. Logically, they're a representation of a number. You can represent them as strings, but they aren't plug-compatible with strings. For this reason, a Roman number won't implement `to_str`—it isn't really a string. Just to drive this home: Roman numerals can be converted to strings using `to_s`, but they aren't inherently strings, so they don't implement `to_str`.

To see how this works in practice, let's look at opening a file. The first parameter to `File.new` can be either an existing file descriptor (represented by an integer) or a file name to open. However, Ruby doesn't simply look at the first parameter and check whether its type is `Fixnum` or `String`. Instead, it gives the object passed in the opportunity to represent itself as a number or a string. If it were written in Ruby, it may look something like

```
class File
 def File.new(file, *args)
 if file.respond_to?(:to_int)
 IO.new(file.to_int, *args)
 else
 name = file.to_str
 # call operating system to open file 'name'
 end
 end
end
```



So let's see what happens if we want to pass a file descriptor integer stored as a Roman number into `File.new`. Because our class implements `to_int`, the first `respond_to?` test will succeed. We'll pass an integer representation of our number to `IO.open`, and the file descriptor will be returned, all wrapped up in a new IO object.

A small number of strict conversion functions are built into the standard library.

#### **to\_ary** → **Array**

Used when interpreter needs to convert a object into an array for parameter passing or multiple assignment.

```
class OneTwo
 def to_ary
 [1, 2]
 end
end

ot = OneTwo.new
a, b = ot
puts "a = #{a}, b = #{b}"
printf("%d -- %d\n", *ot)
```

*produces:*

```
a = 1, b = 2
1 -- 2
```

#### **to\_hash** → **Hash**

Used when the interpreter expects to see Hash. (The only known use is the second parameter to `Hash#replace`.)

#### **to\_int** → **Integer**

Used when the interpreter expects to see an integer value (such as a file descriptor or as a parameter to `Kernel.Integer`).

#### **to\_io** → **IO**

Used when the interpreter is expecting IO objects (for example, as parameters to `IO#reopen` or `IO.select`).

#### **to\_proc** → **Proc**

Used to convert an object prefixed with an ampersand in a method call.

```
class OneTwo
 def to_proc
 proc { "one-two" }
 end
end

def silly
 yield
end

ot = OneTwo.new
silly(&ot) → "one-two"
```

**to\_str** → **String**

Used pretty much any place the interpreter is looking for a String value.

```
class OneTwo
 def to_str
 "one-two"
 end
end
ot = OneTwo.new
puts("count: " + ot)
File.open(ot) rescue puts $!.message
```

*produces:*

```
count: one-two
No such file or directory - one-two
```

Note, however, that the use of `to_str` is not universal—some methods that want string arguments do not call `to_str`.

```
File.join("/user", ot) → "/user/#<OneTwo:0x1c974c>"
```

**to\_sym** → **Symbol**

Express the receiver as a symbol. Not used by the interpreter for conversions and probably not useful in user code.

One last point: classes such as `Integer` and `Fixnum` implement the `to_int` method, and `String` implements `to_str`. That way you can call the strict conversion functions polymorphically:

```
it doesn't matter if obj is a Fixnum or a
Roman number, the conversion still succeeds
num = obj.to_int
```

## Numeric Coercion

Back on page 356 we said there were three types of conversion performed by the interpreter. We covered loose and strict conversion. The third is numeric coercion.

Here's the problem. When you write "1+2", Ruby knows to call the `+` on the object 1 (a `Fixnum`), passing it the `Fixnum` 2 as a parameter. However, when you write "1+2.3", the same `+` method now receives a `Float` parameter. How can it know what to do (particularly as checking the classes of your parameters is against the spirit of duck typing)?

The answer lies in Ruby's coercion protocol, based on the method `coerce`. The basic operation of `coerce` is simple. It takes two numbers (one as its receiver, the other as a parameter). It returns a two-element array containing representations of these two numbers (but with the parameter first, followed by the receiver). The `coerce` method

guarantees that these two objects will have the same class and therefore that they can be added (or multiplied, or compared, or whatever).

```
1.coerce(2) → [2, 1]
1.coerce(2.3) → [2.3, 1.0]
(4.5).coerce(2.3) → [2.3, 4.5]
(4.5).coerce(2) → [2.0, 4.5]
```

The trick is that the receiver calls the `coerce` method of its parameter to generate this array. This technique, called *double dispatch*, allows a method to change its behavior based not only on its class but also on the class of its parameter. In this case, we're letting the parameter decide exactly *what* classes of objects should get added (or multiplied, divided, and so on).

Let's say that we're writing a new class that's intended to take part in arithmetic. To participate in coercion, we need to implement a `coerce` method. This takes some other kind of number as a parameter and returns an array containing two objects of the same class, whose values are equivalent to its parameter and itself.

For our Roman number class, it's fairly easy. Internally, each Roman number object holds its real value as a `Fixnum` in an instance variable, `@value`. The `coerce` method checks to see if the class of its parameter is also an `Integer`. If so, it returns its parameter and its internal value. If not, it first converts both to floating point.

```
class Roman
 def initialize(value)
 @value = value
 end

 def coerce(other)
 if Integer === other
 [other, @value]
 else
 [Float(other), Float(@value)]
 end
 end

 # .. other Roman stuff
end

iv = Roman.new(4)
xi = Roman.new(11)

3 * iv → 12
1.1 * xi → 12.1
```

Of course, class `Roman` as implemented doesn't know how to do addition itself: you couldn't have written "`xi + 3`" in the previous example, as `Roman` doesn't have a "plus" method. And that's probably as it should be. But let's go wild and implement addition for Roman numbers.

```

class Roman
 MAX_ROMAN = 4999
 attr_reader :value
 protected :value
 def initialize(value)
 if value <= 0 || value > MAX_ROMAN
 fail "Roman values must be > 0 and <= #{MAX_ROMAN}"
 end
 @value = value
 end
 def coerce(other)
 if Integer === other
 [other, @value]
 else
 [Float(other), Float(@value)]
 end
 end
 def +(other)
 if Roman === other
 other = other.value
 end
 if Fixnum === other && (other + @value) < MAX_ROMAN
 Roman.new(@value + other)
 else
 x, y = other.coerce(@value)
 x + y
 end
 end
 FACTORS = [["m", 1000], ["cm", 900], ["d", 500], ["cd", 400],
 ["c", 100], ["xc", 90], ["l", 50], ["xl", 40],
 ["x", 10], ["ix", 9], ["v", 5], ["iv", 4],
 ["i", 1]]
 def to_s
 value = @value
 roman = ""
 for code, factor in FACTORS
 count, value = value.divmod(factor)
 roman << (code * count)
 end
 roman
 end
end

iv = Roman.new(4)
xi = Roman.new(11)

iv + 3 → vii
iv + 3 + 4 → xi
iv + 3.14159 → 7.14159
xi + 4900 → mmmcmxi
xi + 4990 → 5001

```

Finally, be careful with `coerce`—try always to coerce into a more general type, or you may end up generating coercion loops, where `A` tries to coerce to `B`, and `B` tries to coerce back to `A`.

## Walk the Walk, Talk the Talk

Duck typing can generate controversy. Every now and then a thread flares on the mailing lists, or someone blogs for or against the concept. Many of the contributors to these discussions have some fairly extreme positions.

Ultimately, though, duck typing isn't a set of rules; it's just a style of programming. Design your programs to balance paranoia and flexibility. If you feel the need to constrain the types of objects that the users of a method pass in, ask yourself why. Try to determine what could go wrong if you were expecting a `String` and instead get an `Array`. Sometimes, the difference is crucially important. Often, though, it isn't. Try erring on the more permissive side for a while, and see if bad things happen. If not, perhaps duck typing isn't just for the birds.

# Classes and Objects

---

Classes and objects are obviously central to Ruby, but at first sight they can seem a little confusing. There seem to be a lot of concepts: classes, objects, class objects, instance methods, class methods, singleton classes, and virtual classes. In reality, however, Ruby has just a single underlying class and object structure, which we'll discuss in this chapter. In fact, the basic model is so simple, we can describe it in a single paragraph.

A Ruby object has three components: a set of flags, some instance variables, and an associated class. A Ruby class is an object of class `Class`, which contains all the object things plus a list of methods and a reference to a superclass (which is itself another class). All method calls in Ruby nominate a receiver (which is by default `self`, the current object). Ruby finds the method to invoke by looking at the list of methods in the receiver's class. If it doesn't find the method there, it looks in any included modules, then in its superclass, modules in the superclass, and then in the superclass's superclass, and so on. If the method cannot be found in the receiver's class or any of its ancestors, Ruby invokes the method `method_missing` on the original receiver.

And that's it—the entire explanation. On to the next chapter.

“But wait,” you cry, “I spent good money on this chapter. What about all this other stuff—virtual classes, class methods, and so on. How do they work?” Good question.

## How Classes and Objects Interact

All class/object interactions are explained using the simple model given above: objects reference classes, and classes reference zero or more superclasses. However, the implementation details can get a tad tricky.

We've found that the simplest way of visualizing all this is to draw the actual structures that Ruby implements. So, in the following pages we'll look at all the possible combinations of classes and objects. Note that these are not class diagrams in the UML sense; we're showing structures in memory and pointers between them.

Figure 24.1. A basic object, with its class and superclass

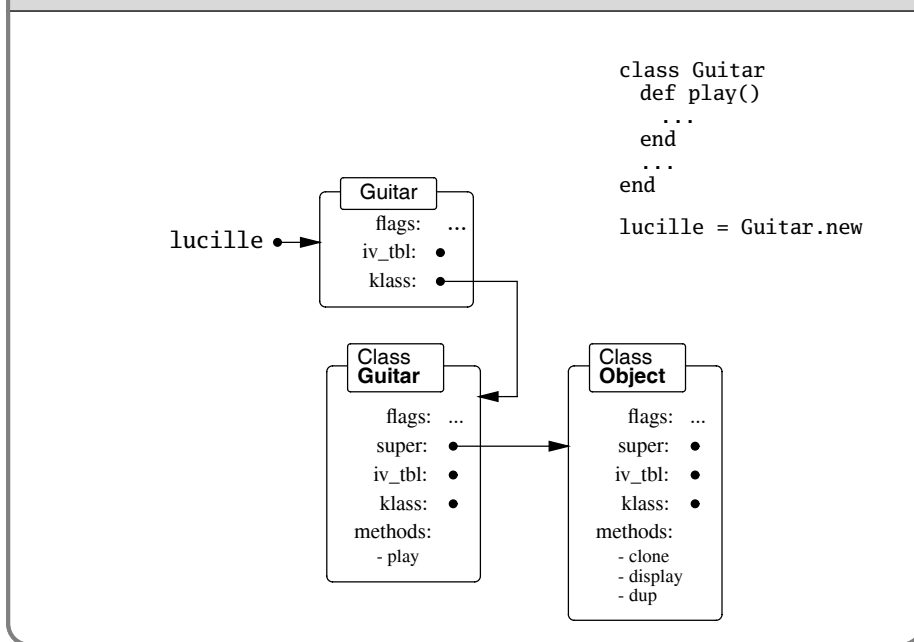

## Your Basic, Everyday Object

Let's start by looking at an object created from a simple class. Figure 24.1 shows an object referenced by a variable, `lucille`; the object's class, `Guitar`; and that class's superclass, `Object`. Notice how the object's class reference, `klass`, points to the class object and how the `super` pointer from that class references the parent class.

If we invoke the method `lucille.play()`, Ruby goes to the receiver, `lucille`, and follows the `klass` reference to the class object for `Guitar`. It searches the method table, finds `play`, and invokes it.

If instead we call `lucille.display()`, Ruby starts off the same way but cannot find `display` in the method table in class `Guitar`. It then follows the `super` reference to `Guitar`'s superclass, `Object`, where it finds and executes the method.

## What's the Meta?

Astute readers (yup, that's all of you) will have noticed that the `klass` members of `Class` objects point to nothing meaningful in Figure 24.1. We now have all the information we need to work out what they *should* reference.

When you say `lucille.play()`, Ruby follows `lucille`'s `klass` pointer to find a class object in which to search for methods. So what happens when you invoke a

Figure 24.2. Adding a metaclass to Guitar

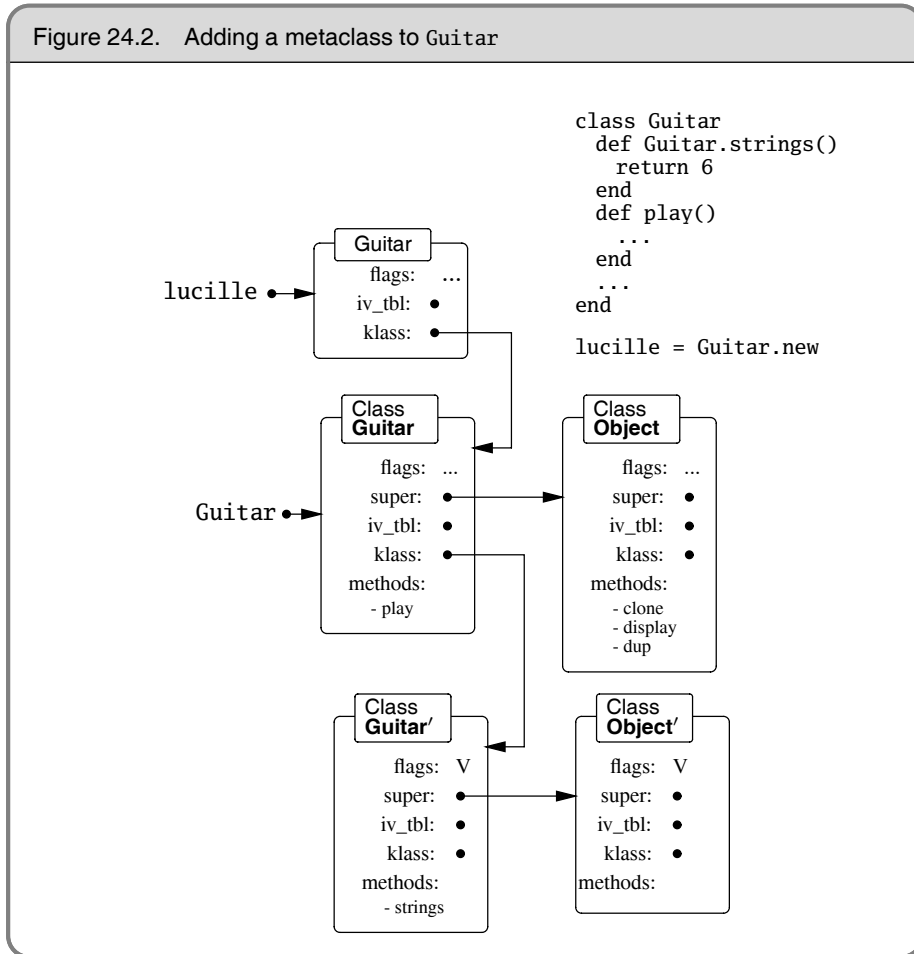

class method, such as `Guitar.strings(...)`? Here the receiver is the class object itself, `Guitar`. So, to be consistent, we need to stick the methods in some other class, referenced from `Guitar`'s `klass` pointer. This new class will contain all of `Guitar`'s class methods. Although the terminology is slightly dubious, we'll call this a *metaclass* (see the sidebar on the next page). We'll denote the metaclass of `Guitar` as `Guitar'`. But that's not the whole story. Because `Guitar` is a subclass of `Object`, its metaclass `Guitar'` will be a subclass of `Object`'s metaclass, `Object'`. In Figure 24.2, we show these additional metaclasses.

When Ruby executes `Guitar.strings()`, it follows the same process as before: it goes to the receiver, class `Guitar`; follows the `klass` reference to class `Guitar'`; and finds the method.

Finally, note that a *V* has crept into the flags in class `Guitar'`. The classes that Ruby creates automatically are marked internally as *virtual classes*. Virtual classes are treated



### Metaclasses and Singleton Classes

During the review of this book, the use of the term *metaclass* generated a fair amount of discussion, as Ruby's metaclasses are different from those in languages such as Smalltalk. Eventually, Matz weighed in with the following

You can call it *metaclass* but, unlike Smalltalk, it's not a class of a class; it's a singleton class of a class.

- Every object in Ruby has its own attributes (methods, constants, and so on) that in other languages are held by classes. It's just like each object having its own class.
- To handle per-object attributes, Ruby provides a classlike *something* for each object that is sometimes called a *singleton class*.
- In the current implementation, singleton classes are specially flagged class objects between objects and their class. These can be “virtual” classes if the language implementer chooses.
- Singleton classes for classes behave just like Smalltalk's metaclasses.

slightly differently within Ruby. The most obvious difference from the outside is that they are effectively invisible: they will never appear in a list of objects returned from methods such as `Module#ancestors` or `ObjectSpace.each_object`, and you cannot create instances of them using `new`.

## Object-Specific Classes

Ruby allows you to create a class tied to a particular object. In the following example, we create two `String` objects. We then associate an anonymous class with one of them, overriding one of the methods in the object's base class and adding a new method.

```
a = "hello"
b = a.dup
class <<a
 def to_s
 "The value is '#{self}'"
 end
 def two_times
 self + self
 end
end
```

```

a.to_s → "The value is 'hello'"
a.two_times → "hellohello"
b.to_s → "hello"

```

This example uses the `class <<obj` notation, which basically says “build me a new class just for object *obj*.” We could also have written it as

```

a = "hello"
b = a.dup
def a.to_s
 "The value is '#{self}'"
end
def a.two_times
 self + self
end

a.to_s → "The value is 'hello'"
a.two_times → "hellohello"
b.to_s → "hello"

```

The effect is the same in both cases: a class is added to the object `a`. This gives us a strong hint about the Ruby implementation: a virtual class is created and inserted as `a`'s direct class. `a`'s original class, `String`, is made this virtual class's superclass. The before and after pictures are shown in Figure 24.3 on the next page.

Remember that in Ruby classes are never closed; you can always open a class and add new methods to it. The same applies to virtual classes. If an object's `klass` reference already points to a virtual class, a new one will not be created. This means that the first of the two method definitions in the previous example will create a virtual class, but the second will simply add a method to it.

The `Object#extend` method adds the methods in its parameter to its receiver, so it also creates a virtual class if needed. `obj.extend(Mod)` is basically equivalent to

```

class <<obj
 include Mod
end

```

## Mixin Modules

When a class includes a module, that module's instance methods become available as instance methods of the class. It's almost as if the module becomes a superclass of the class that uses it. Not surprisingly, that's about how it works. When you include a module, Ruby creates an anonymous proxy class that references that module and inserts that proxy as the direct superclass of the class that did the including. The proxy class contains references to the instance variables and methods of the module. This is important: the same module may be included in many different classes and will appear in many different inheritance chains. However, thanks to the proxy class, there is still

Figure 24.3. Adding a virtual class to an object

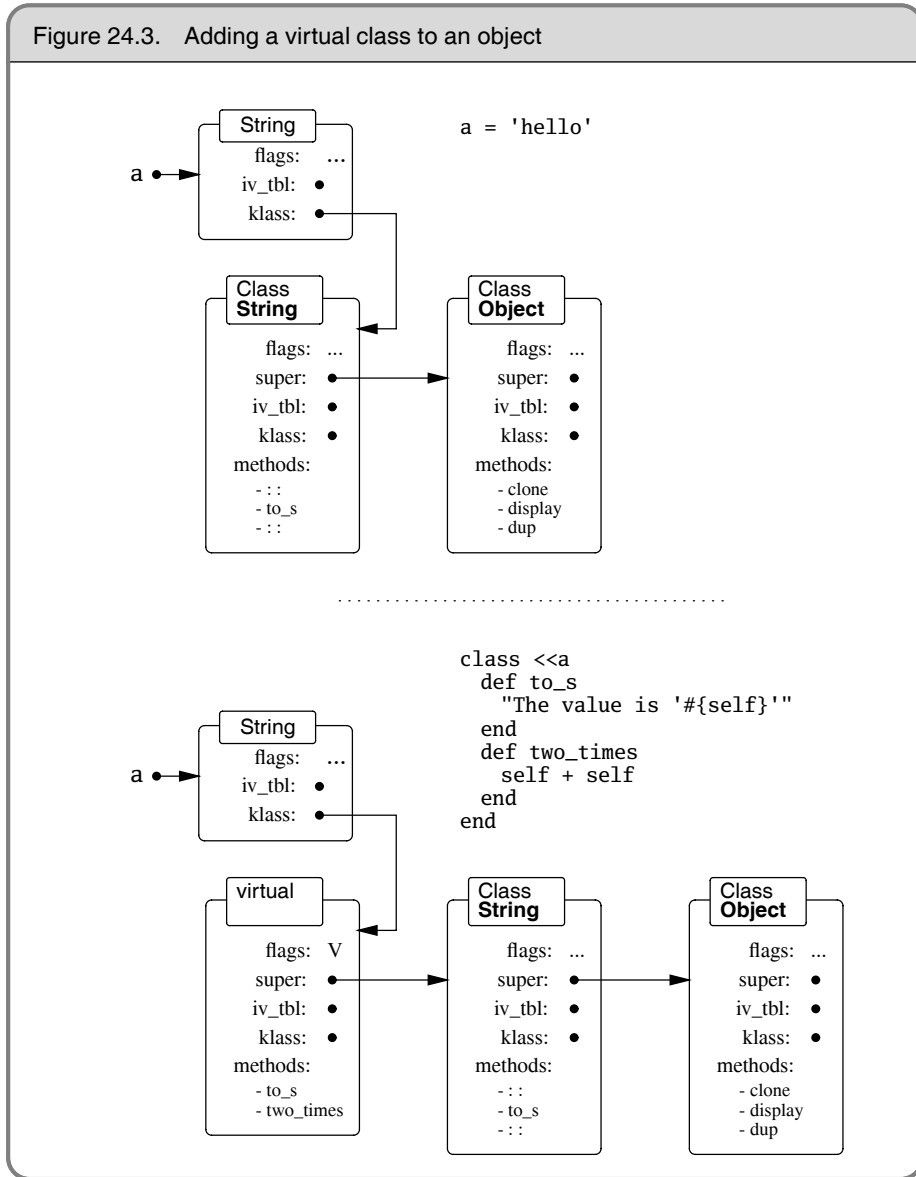

only one underlying module: change a method definition in that module, and it will change in all classes that include that module, both past and future.

```

module SillyModule
 def hello
 "Hello."
 end
end

class SillyClass
 include SillyModule
end

s = SillyClass.new
s.hello → "Hello."

module SillyModule
 def hello
 "Hi, there!"
 end
end

s.hello → "Hi, there!"

```

The relationship between classes and the mixin modules they include is shown in Figure 24.4 on the following page. If multiple modules are included, they are added to the chain in order.

If a module itself includes other modules, a chain of proxy classes will be added to any class that includes that module, one proxy for each module that is directly or indirectly included.

## Extending Objects

Just as you can define an anonymous class for an object using `class <<obj`, you can mix a module into an object using `Object#extend`. For example:

```

module Humor
 def tickle
 "hee, hee!"
 end
end

a = "Grouchy"
a.extend Humor
a.tickle → "hee, hee!"

```

There is an interesting trick with `extend`. If you use it within a class definition, the module's methods become class methods. This is because calling `extend` is equivalent to `self.extend`, so the methods are added to `self`, which in a class definition is the class itself.

Figure 24.4. An included module and its proxy class

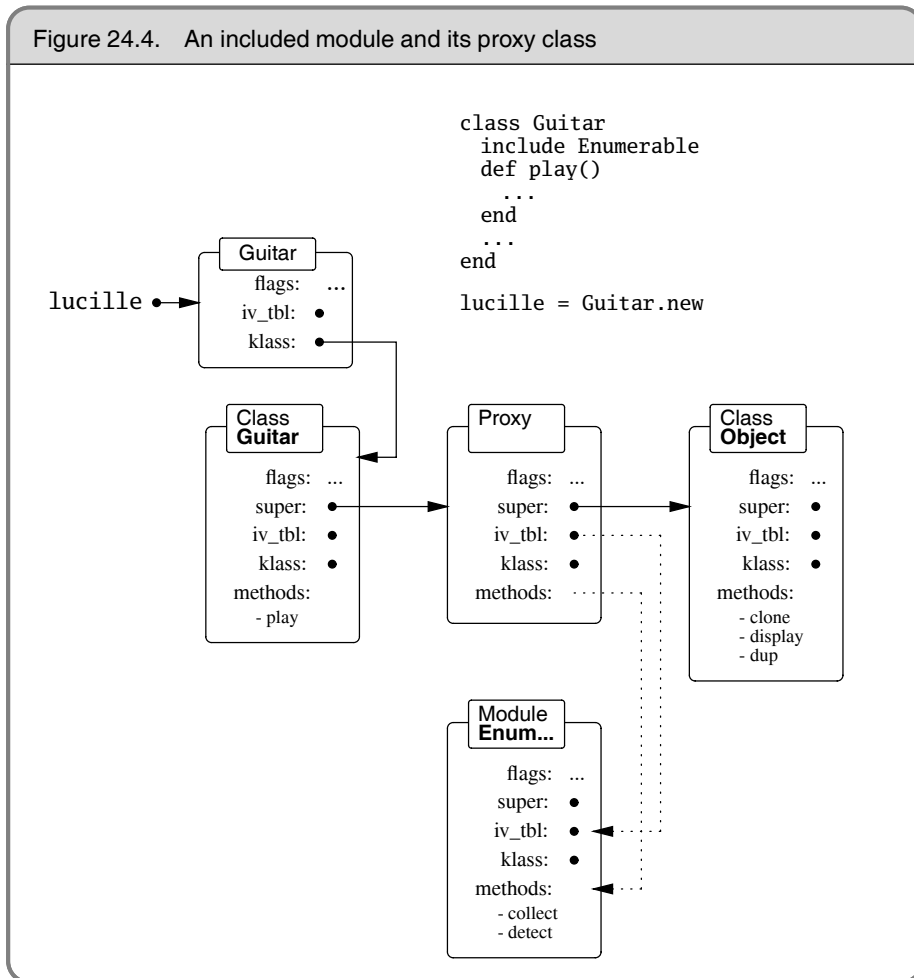

Here's an example of adding a module's methods at the class level.

```

module Humor
 def tickle
 "hee, hee!"
 end
end
class Grouchy
 include Humor
 extend Humor
end

```

```

Grouchy.tickle → "hee, hee!"
a = Grouchy.new
a.tickle → "hee, hee!"

```

## Class and Module Definitions

Having exhausted the combinations of classes and objects, we can (thankfully) get back to programming by looking at the nuts and bolts of class and module definitions.

In languages such as C++ and Java, class definitions are processed at compile time: the compiler creates symbol tables, works out how much storage to allocate, constructs dispatch tables, and does all those other obscure things we'd rather not think too hard about.

Ruby is different. In Ruby, class and module definitions are executable code. Although parsed at compile time, the classes and modules are created at runtime, when the definition is encountered. (The same is also true of method definitions.) This allows you to structure your programs far more dynamically than in most conventional languages. You can make decisions once, when the class is being defined, rather than each time those objects of the class are used. The class in the following example decides as it is being defined what version of a decryption routine to create.

```
module Tracing
 # ...
end
class MediaPlayer
 include Tracing if $DEBUG
 if ::EXPORT_VERSION
 def decrypt(stream)
 raise "Decryption not available"
 end
 else
 def decrypt(stream)
 # ...
 end
 end
end
end
```

If class definitions are executable code, this implies that they execute in the context of some object: `self` must reference *something*. Let's find out what it is.

```
class Test
 puts "Class of self = #{self.class}"
 puts "Name of self = #{self.name}"
end
```

*produces:*

```
Class of self = Class
Name of self = Test
```

This means that a class definition is executed with that class as the current object. Referring back to the section about metaclasses on page 363, we can see that this means

that methods in the metaclass and its superclasses will be available during the execution of the method definition. We can check this out.

```
class Test
 def Test.say_hello
 puts "Hello from #{name}"
 end
 say_hello
end
```

*produces:*

```
Hello from Test
```

In this example we define a class method, `Test.say_hello`, and then call it in the body of the class definition. Within `say_hello`, we call `name`, an instance method of class `Module`. Because `Module` is an ancestor of `Class`, its instance methods can be called without an explicit receiver within a class definition.

## Class Instance Variables

If a class definition is executed in the context of some object, that implies that a class may have instance variables.

```
class Test
 @cls_var = 123
 def Test.inc
 @cls_var += 1
 end
end
```

```
Test.inc → 124
Test.inc → 125
```

If classes have their own instance variables, can we use `attr_reader` and `friends` to access them? We can, but we have to run these methods in the correct place. For regular instance variables, the attribute accessors are defined at the class level. For class instance variables, we have to define the accessors in the metaclass.

```
class Test
 @cls_var = 123
 class <<self
 attr_reader :cls_var
 end
end
```

```
Test.cls_var → 123
```

This leads us to an interesting point. Many of the directives that you use when defining a class or module, things such as `alias_method`, `attr`, and `public`, are simply methods in class `Module`. This creates some intriguing possibilities—you can extend

the functionality of class and module definitions by writing Ruby code. Let's look at a couple of examples.

As a first example, let's look at adding a basic documentation facility to modules and classes. This would allow us to associate a string with modules and classes that we write, a string that is accessible as the program is running. We'll choose a simple syntax.

```
class Example
 doc "This is a sample documentation string"
 # .. rest of class
end
```

We need to make `doc` available to any module or class, so we need to make it an instance method of class `Module`.

```
class Module
 @@docs = {}
 # Invoked during class definitions
 def doc(str)
 @@docs[self.name] = self.name + ":\n" + str.gsub(/\s+/, '')
 end
 # invoked to get documentation
 def Module::doc(aClass)
 # If we're passed a class or module, convert to string
 # ('<=' for classes checks for same class or subtype)
 aClass = aClass.name if aClass.class <= Module
 @@docs[aClass] || "No documentation for #{aClass}"
 end
end

class Example
 doc "This is a sample documentation string"
 # .. rest of class
end

module Another
 doc <<-edoc
 And this is a documentation string
 in a module
 edoc
 # rest of module
end

puts Module::doc(Example)
puts Module::doc("Another")
```

*produces:*

```
Example:
This is a sample documentation string
Another:
And this is a documentation string
in a module
```



The second example is a performance enhancement based on Tadayoshi Funaba's date module (described beginning on page 644). Say we have a class that represents some underlying quantity (in this case, a date). The class may have many attributes that present the same underlying date in different ways: as a Julian day number, as a string, as a [year, month, day] triple, and so on. Each value represents the same date and may involve a fairly complex calculation to derive. We therefore would like to calculate each attribute only once, when it is first accessed.

The manual way would be to add a test to each accessor.

```
class ExampleDate
 def initialize(day_number)
 @day_number = day_number
 end
 def as_day_number
 @day_number
 end
 def as_string
 unless @string
 # complex calculation
 @string = result
 end
 @string
 end
 def as_YMD
 unless @ymd
 # another calculation
 @ymd = [y, m, d]
 end
 @ymd
 end
 # ...
end
```

This is a clunky technique—let's see if we can come up with something sexier.

What we're aiming for is a directive that indicates that the body of a particular method should be invoked only once. The value returned by that first call should be cached. Thereafter, calling that same method should return the cached value without reevaluating the method body again. This is similar to Eiffel's once modifier for routines. We'd like to be able to write something such as

```
class ExampleDate
 def as_day_number
 @day_number
 end
 def as_string
 # complex calculation
 end
end
```

```

def as_YMD
 # another calculation
 [y, m, d]
end
once :as_string, :as_YMD
end

```

We can use `once` as a directive by writing it as a class method of `ExampleDate`, but what should it look like internally? The trick is to have it rewrite the methods whose names it is passed. For each method, it creates an alias for the original code, and then creates a new method with the same name. Here's Tadayoshi Funaba's code, slightly reformatted.

```

def once(*ids) # :nodoc:
 for id in ids
 module_eval <<-"end;"
 alias_method :__#{id.to_i}__, :#{id.to_s}
 private :__#{id.to_i}__
 def #{id.to_s}(*args, &block)
 (@__#{id.to_i}__ ||= [__#{id.to_i}__(*args, &block)])[0]
 end
 end;
 end
end

```

This code uses `module_eval` to execute a block of code in the context of the calling module (or, in this case, the calling class). The original method is renamed `__nnn__`, where the `nnn` part is the integer representation of the method name's symbol ID. The code uses the same name for the caching instance variable. A method with the original name is then defined. If the caching instance variable has a value, that value is returned; otherwise the original method is called, and its return value cached and returned.

Understand this code, and you'll be well on the way to true Ruby mastery.

However, we can take it further. Look in the `date` module, and you'll see method `once` written slightly differently.

```

class Date
 class << self
 def once(*ids)
 # ...
 end
 end
 # ...
end

```

The interesting thing here is the inner class definition, `class << self`. This defines a class based on the object `self`, and `self` happens to be the class object for `Date`. The result? Every method within the inner class definition is automatically a class method of `Date`.

The `once` feature is generally applicable—it should work for any class. If you took `once` and made it a private instance method of class `Module`, it would be available for use in any Ruby class. (And of course you *could* do this, as class `Module` is open, and you are free to add methods to it.)

## Class Names Are Constants

We've said that when you invoke a class method, all you're doing is sending a message to the `Class` object itself. When you say something such as `String.new("gumby")`, you're sending the message `new` to the object that is class `String`. But how does Ruby know to do this? After all, the receiver of a message should be an object reference, which implies that there must be a constant called `String` somewhere containing a reference to the `String` object.<sup>1</sup> And in fact, that's exactly what happens. All the built-in classes, along with the classes you define, have a corresponding global constant with the same name as the class. This is both straightforward and subtle. The subtlety comes from the fact that two things are named (for example) `String` in the system. There's a *constant* that references class `String` (an object of class `Class`), and there's the (class) object itself.

The fact that class names are just constants means that you can treat classes just like any other Ruby object: you can copy them, pass them to methods, and use them in expressions.

```
def factory(klass, *args)
 klass.new(*args)
end

factory(String, "Hello") → "Hello"
factory(Dir, ".") → #<Dir:0x1c90e4>

flag = true
(flag ? Array : Hash)[1, 2, 3, 4] → [1, 2, 3, 4]
flag = false
(flag ? Array : Hash)[1, 2, 3, 4] → {1=>2, 3=>4}
```

This has another facet: if a class with no name is assigned to a constant, Ruby gives the class the name of the constant.

```
var = Class.new
var.name → ""

Wibble = var
var.name → "Wibble"
```

---

1. It will be a constant, not a variable, because *String* starts with an uppercase letter.

## Top-Level Execution Environment

Many times in this book we've claimed that everything in Ruby is an object. However, we've used one thing time and time again that appears to contradict this—the top-level Ruby execution environment.

```
puts "Hello, World"
```

Not an object in sight. We may as well be writing some variant of Fortran or BASIC. But dig deeper, and you'll come across objects and classes lurking in even the simplest code.

We know that the literal "Hello, World" generates a Ruby String, so that's one object. We also know that the bare method call to `puts` is effectively the same as `self.puts`. But what is `self`?

```
self.class → Object
```

At the top level, we're executing code in the context of some predefined object. When we define methods, we're actually creating (private) instance methods for class `Object`. This is fairly subtle; as they are in class `Object`, these methods are available everywhere. And because we're in the context of `Object`, we can use all of `Object`'s methods (including those mixed-in from `Kernel`) in function form. This explains why we can call `Kernel` methods such as `puts` at the top level (and indeed throughout Ruby): these methods are part of every object.

Top-level instance variables also belong to this top-level object.

## Inheritance and Visibility

The one last wrinkle to class inheritance is fairly obscure.

Within a class definition, you can change the visibility of a method in an ancestor class. For example, you can do something like

```
class Base
 def aMethod
 puts "Got here"
 end
 private :aMethod
end

class Derived1 < Base
 public :aMethod
end

class Derived2 < Base
end
```

In this example, you would be able to invoke `aMethod` in instances of class `Derived1` but not via instances of `Base` or `Derived2`.

So how does Ruby pull off this feat of having one method with two different visibilities? Simply put, it cheats.

If a subclass changes the visibility of a method in a parent, Ruby effectively inserts a hidden proxy method in the subclass that invokes the original method using `super`. It then sets the visibility of that proxy to whatever you requested. This means that the code

```
class Derived1 < Base
 public :aMethod
end
```

is effectively the same as

```
class Derived1 < Base
 def aMethod(*args)
 super
 end
 public :aMethod
end
```

The call to `super` can access the parent’s method regardless of its visibility, so the rewrite allows the subclass to override its parent’s visibility rules. Pretty scary, eh?

## Freezing Objects

Sometimes you’ve worked hard to make your object exactly right, and you’ll be damned if you’ll let anyone just change it. Perhaps you need to pass some kind of opaque object between two of your classes via some third-party object, and you want to make sure it arrives unmodified. Perhaps you want to use an object as a hash key and need to make sure that no one modifies it while it’s being used. Perhaps something is corrupting one of your objects, and you’d like Ruby to raise an exception as soon as the change occurs.

Ruby provides a very simple mechanism to help with this. Any object can be *frozen* by invoking `Object#freeze`. A frozen object may not be modified: you can’t change its instance variables (directly or indirectly), you can’t associate singleton methods with it, and, if it is a class or module, you can’t add, delete, or modify its methods. Once frozen, an object stays frozen: there is no `Object#thaw`. You can test to see if an object is frozen using `Object#frozen?`.

What happens when you copy a frozen object? That depends on the method you use. If you call an object’s `clone` method, the entire object state (including whether it is frozen) is copied to the new object. On the other hand, `dup` typically copies only the object’s contents—the new copy will not inherit the frozen status.

```
str1 = "hello"
str1.freeze → "hello"
str1.frozen? → true
str2 = str1.clone
str2.frozen? → true
str3 = str1.dup
str3.frozen? → false
```

Although freezing objects may initially seem like a good idea, you may want to hold off doing it until you come across a real need. Freezing is one of those ideas that looks essential on paper but isn't used much in practice.

# Locking Ruby in the Safe

---

Walter Webcoder has a great idea for a portal site: the Web Arithmetic Page. Surrounded by all sorts of cool mathematical links and banner ads that will make him rich is a simple Web form containing a text field and a button. Users type an arithmetic expression into the field, click the button, and the answer is displayed. All the world's calculators become obsolete overnight; Walter cashes in and retires to devote his life to his collection of car license plate numbers.

Implementing the calculator is easy, thinks Walter. He accesses the contents of the form field using Ruby's CGI library and uses the `eval` method to evaluate the string as an expression.

```
require 'cgi'
cgi = CGI.new("html4")
Fetch the value of the form field "expression"
expr = cgi["expression"].to_s
begin
 result = eval(expr)
rescue Exception => detail
 # handle bad expressions
end
display result back to user...
```

Roughly seven seconds after Walter puts the application online, a twelve-year-old from Waxahachie with glandular problems and no real life types `system("rm *")` into the form and, like his computer's files, Walter's dreams come tumbling down.

Walter learned an important lesson: *All external data is dangerous. Don't let it close to interfaces that can modify your system.* In this case, the content of the form field was the external data, and the call to `eval` was the security breach.

Fortunately, Ruby provides support for reducing this risk. All information from the outside world can be marked as *tainted*. When running in a safe mode, potentially dangerous methods will raise a `SecurityError` if passed a tainted object.

## Safe Levels

The variable `SAFE` determines Ruby’s level of paranoia. Table 25.1 on page 383 gives more details of the checks performed at each safe level.

<code>SAFE</code>	Constraints
0	No checking of the use of externally supplied (tainted) data is performed. This is Ruby’s default mode.
$\geq 1$	Ruby disallows the use of tainted data by potentially dangerous operations.
$\geq 2$	Ruby prohibits the loading of program files from globally writable locations.
$\geq 3$	All newly created objects are considered tainted.
$\geq 4$	Ruby effectively partitions the running program in two. Nontainted objects may not be modified.

The default value of `SAFE` is zero under most circumstances. However, if a Ruby script is run `setuid` or `setgid`,<sup>1</sup> or if it run under `mod_ruby`, its safe level is automatically set to 1. The safe level may also be set by using the `-T` command-line option and by assigning to `SAFE` within the program. It is not possible to lower the value of `SAFE` by assignment.

The current value of `SAFE` is inherited when new threads are created. However, within each thread, the value of `SAFE` may be changed without affecting the value in other threads. This facility may be used to implement secure “sandboxes,” areas where external code may run safely without risk to the rest of your application or system. Do this by wrapping code that you load from a file in its own, anonymous module. This will protect your program’s namespace from any unintended alteration.

```
f=open(filename,"w")
f.print ... # write untrusted program into file.
f.close
Thread.start do
 SAFE = 4
 load(filename, true)
end
```

With a `SAFE` level of 4, you can load *only* wrapped files. See the description of `Kernel.load` on page 503 for details.

This concept is used by Clemens Wyss on Ruby Channel (<http://www.ruby.ch>). On this site, you can run the code from the first edition of this book. You can also type

---

1. A Unix script may be flagged to be run under a different user or group ID than the person running it. This allows the script to have privileges that the user does not have; the script can access resources that the user would otherwise be prohibited from using. These scripts are called `setuid` or `setgid`.



Ruby code into a window and execute it. And yet he doesn't lose sleep at night, as his site runs your code in a sandbox.

You can find a listing of the Ruby source code for this sandbox on the Web at [http://www.approximity.com/cgi-bin/rubybuch\\_wiki/wpage.rb?nd=214](http://www.approximity.com/cgi-bin/rubybuch_wiki/wpage.rb?nd=214).

### 1.8

The safe level in effect when a Proc object is created is stored with that object. A Proc may not be passed to a method if it is tainted and the current safe level is greater than that in effect when the block was created.

## Tainted Objects

Any Ruby object derived from some external source (for example, a string read from a file or an environment variable) is automatically marked as being tainted. If your program uses a tainted object to derive a new object, then that new object will also be tainted, as shown in the code below. Any object with external data somewhere in its past will be tainted. This tainting process is performed regardless of the current safe level. You can see if an object is tainted using `Object#tainted?`.

# internal data		# external data	
# =====		# =====	
<code>x1 = "a string"</code>		<code>y1 = ENV["HOME"]</code>	
<code>x1.tainted?</code>	→ false	<code>y1.tainted?</code>	→ true
<code>x2 = x1[2, 4]</code>		<code>y2 = y1[2, 4]</code>	
<code>x2.tainted?</code>	→ false	<code>y2.tainted?</code>	→ true
<code>x1 =~ /[a-z]/</code>	→ 0	<code>y1 =~ /[a-z]/</code>	→ 2
<code>\$1.tainted?</code>	→ false	<code>\$1.tainted?</code>	→ true

You can force any object to become tainted by invoking its `taint` method. If the safe level is less than 3, you can remove the taint from an object by invoking `untaint`.<sup>2</sup> This is not something to do lightly.

Clearly, Walter should have run his CGI script at a safe level of 1. This would have raised an exception when the program tried to pass form data to `eval`. Once this had happened, Walter would have had a number of choices. He could have chosen to implement a proper expression parser, bypassing the risks inherent in using `eval`. However, being lazy, it's more likely he'd have performed some simple sanity check on the form data and `untaint` it if it looked innocuous.

---

2. You can also use some devious tricks to do this without using `untaint`. We'll leave it up to your darker side to find them.

```
require 'cgi';
$SAFE = 1
cgi = CGI.new("html4")
expr = cgi["expression"].to_s
if expr =~ %r{\A[-+*/\d\seE.()]*\z}
 expr.untaint
 result = eval(expr)
 # display result back to user...
else
 # display error message...
end
```

Personally, we think Walter is still taking undue risks. We'd probably prefer to see a real parser here, but implementing one here has nothing to teach us about tainting, so we'll move onto other topics.

Table 25.1. Definition of the safe levels

1.8**\$\$SAFE >= 1**

- The environment variables RUBYLIB and RUBYOPT are not processed, and the current directory is not added to the path.
- The command-line options `-e`, `-i`, `-I`, `-r`, `-s`, `-S`, and `-x` are not allowed.
- Can't start processes from \$PATH if any directory in it is world-writable.
- Can't manipulate or chroot to a directory whose name is a tainted string.
- Can't glob tainted strings.
- Can't eval tainted strings.
- Can't load or require a file whose name is a tainted string (unless the load is wrapped).
- Can't manipulate or query the status of a file or pipe whose name is a tainted string.
- Can't execute a system command or exec a program from a tainted string.
- Can't pass trap a tainted string.

**\$\$SAFE >= 2**

- Can't change, make, or remove directories, or use chroot.
- Can't load a file from a world-writable directory.
- Can't load a file from a tainted filename starting with `~`.
- Can't use `File#chmod`, `File#chown`, `File#lstat`, `File.stat`, `File#truncate`, `File.umask`, `File#flock`, `IO#ioctl`, `IO#stat`, `Kernel#fork`, `Kernel#syscall`, `Kernel#trap`, `Process.setpgid`, `Process.setsid`, `Process.setpriority`, or `Process.egid=`.
- Can't handle signals using trap.

**\$\$SAFE >= 3**

- All objects are tainted when they are created.
- Can't untaint objects.

**\$\$SAFE >= 4**

- Can't modify a nontainted array, hash, or string.
- Can't modify a global variable.
- Can't access instance variables of nontainted objects.
- Can't change an environment variable.
- Can't close or reopen nontainted files.
- Can't freeze nontainted objects.
- Can't change visibility of methods (`private/public/protected`).
- Can't make an alias in a nontainted class or module.
- Can't get meta-information (such as method or variable lists).
- Can't define, redefine, remove, or undef a method in a nontainted class or module.
- Can't modify Object.
- Can't remove instance variables or constants from nontainted objects.
- Can't manipulate threads, terminate a thread other than the current thread, or set `abort_on_exception`.
- Can't have thread local variables.
- Can't raise an exception in a thread with a lower \$\$SAFE value.
- Can't move threads between ThreadGroups.
- Can't invoke `exit`, `exit!`, or `abort`.
- Can load only wrapped files, and can't include modules in untainted classes and modules.
- Can't convert symbol identifiers to object references.
- Can't write to files or pipes.
- Can't use `autoload`.
- Can't taint objects.

# Reflection, ObjectSpace, and Distributed Ruby

---

One of the many advantages of dynamic languages such as Ruby is the ability to *introspect*—to examine aspects of the program from within the program itself. Java, for one, calls this feature *reflection* but Ruby’s capabilities go beyond Java’s.

The word *reflection* conjures up an image of looking at oneself in the mirror—perhaps investigating the relentless spread of that bald spot on the top of one’s head. That’s a pretty apt analogy: we use reflection to examine parts of our programs that aren’t normally visible from where we stand.

In this deeply introspective mood, while we are contemplating our navels and burning incense (being careful not to swap the two tasks), what can we learn about our program? We might discover

- what objects it contains,
- the class hierarchy,
- the attributes and methods of objects, and
- information on methods.

Armed with this information, we can look at particular objects and decide which of their methods to call at runtime—even if the class of the object didn’t exist when we first wrote the code. We can also start doing clever things, perhaps modifying the program as it’s running.

Sound scary? It needn’t be. In fact, these reflection capabilities let us do some very useful things. Later in this chapter we’ll look at distributed Ruby and marshaling, two reflection-based technologies that let us send objects around the world and through time.

## Looking at Objects

Have you ever craved the ability to traverse *all* the living objects in your program? We have! Ruby lets you perform this trick with `ObjectSpace.each_object`. We can use it to do all sorts of neat tricks.

For example, to iterate over all objects of type `Numeric`, you'd write the following.

```
a = 102.7
b = 95.1
ObjectSpace.each_object(Numeric) {|x| p x }
```

*produces:*

```
95.1
102.7
2.71828182845905
3.14159265358979
2.22044604925031e-16
1.79769313486232e+308
2.2250738585072e-308
```

Hey, where did all those extra numbers come from? We didn't define them in our program. If you look on pages [466](#) and [519](#), you'll see that the `Float` class defines constants for the maximum and minimum float, as well as `epsilon`, the smallest distinguishable difference between two floats. The `Math` module defines constants for  $e$  and  $\pi$ . Since we are examining *all* living objects in the system, these turn up as well.

Let's try the same example with different numbers.

```
a = 102
b = 95
ObjectSpace.each_object(Numeric) {|x| p x }
```

*produces:*

```
2.71828182845905
3.14159265358979
2.22044604925031e-16
1.79769313486232e+308
2.2250738585072e-308
```

Neither of the `Fixnum` objects we created showed up. That's because `ObjectSpace` doesn't know about objects with immediate values: `Fixnum`, `Symbol`, `true`, `false`, and `nil`.

## Looking Inside Objects

Once you've found an interesting object, you may be tempted to find out just what it can do. Unlike static languages, where a variable's type determines its class, and hence the methods it supports, Ruby supports liberated objects. You really cannot tell exactly

what an object can do until you look under its hood.<sup>1</sup> We talk about this in the *Duck Typing* chapter starting on page 349.

For instance, we can get a list of all the methods to which an object will respond.

```
r = 1..10 # Create a Range object
list = r.methods
list.length → 68
list[0..3] → ["collect", "to_a", "instance_eval", "all?"]
```

Or, we can check to see if an object supports a particular method.

```
r.respond_to?("frozen?") → true
r.respond_to?(:has_key?) → false
"me".respond_to?("==") → true
```

We can determine our object's class and its unique object ID and test its relationship to other classes.

```
num = 1
num.id → 3
num.class → Fixnum
num.kind_of? Fixnum → true
num.kind_of? Numeric → true
num.instance_of? Fixnum → true
num.instance_of? Numeric → false
```

## Looking at Classes

Knowing about objects is one part of reflection, but to get the whole picture, you also need to be able to look at classes—the methods and constants that they contain.

Looking at the class hierarchy is easy. You can get the parent of any particular class using `Class#superclass`. For classes *and* modules, `Module#ancestors` lists both superclasses and mixed-in modules.

```
class = Fixnum
begin
 print class
 class = class.superclass
 print " < " if class
end while class
puts
p Fixnum.ancestors
```

*produces:*

```
Fixnum < Integer < Numeric < Object
[Fixnum, Integer, Precision, Numeric, Comparable, Object, Kernel]
```

---

1. Or under its bonnet, for objects created to the east of the Atlantic.

If you want to build a complete class hierarchy, just run that code for every class in the system. We can use `ObjectSpace` to iterate over all `Class` objects.

```
ObjectSpace.each_object(Class) do |klass|
 # ...
end
```

## Looking Inside Classes

We can find out a bit more about the methods and constants in a particular object. Instead of just checking to see whether the object responds to a given message, we can ask for methods by access level, and we can ask for just singleton methods. We can also have a look at the object's constants, local, and instance variables.

1.8

```
class Demo
 @@var = 99
 CONST = 1.23

 private
 def private_method
 end
 protected
 def protected_method
 end
 public
 def public_method
 @inst = 1
 i = 1
 j = 2
 local_variables
 end

 def Demo.class_method
 end
end

Demo.private_instance_methods(false) → ["private_method"]
Demo.protected_instance_methods(false) → ["protected_method"]
Demo.public_instance_methods(false) → ["public_method"]
Demo.singleton_methods(false) → ["class_method"]
Demo.class_variables → ["@@var"]
Demo.constants - Demo.superclass.constants → ["CONST"]

demo = Demo.new
demo.instance_variables → []
Get 'public_method' to return its local variables
and set an instance variable
demo.public_method → ["i", "j"]
demo.instance_variables → ["@inst"]
```

`Module.constants` returns *all* the constants available via a module, including constants from the module's superclasses. We're not interested in those just at the moment, so we'll subtract them from our list.

## 1.8

You may be wondering what all the `false` parameters were in the previous code. As of Ruby 1.8, these reflection methods will by default recurse into parent classes, and their parents, and so on up the ancestor chain. Passing in `false` stops this kind of prying.

Given a list of method names, we may now be tempted to try calling them. Fortunately, that's easy with Ruby.

## Calling Methods Dynamically

C and Java programmers often find themselves writing some kind of dispatch table: functions that are invoked based on a command. Think of a typical C idiom where you have to translate a string to a function pointer.

```
typedef struct {
 char *name;
 void (*fptr)();
} Tuple;

Tuple list[] = {
 { "play", fptr_play },
 { "stop", fptr_stop },
 { "record", fptr_record },
 { 0, 0 },
};

...

void dispatch(char *cmd) {
 int i = 0;
 for (; list[i].name; i++) {
 if (strcmp(list[i].name, cmd, strlen(cmd)) == 0) {
 list[i].fptr();
 return;
 }
 }
 /* not found */
}
```

In Ruby, you can do all this in one line. Stick all your command functions into a class, create an instance of that class (we called it `commands`), and ask that object to execute a method called the same name as the command string.

```
commands.send(command_string)
```

Oh, and by the way, it does much more than the C version—it's dynamic. The Ruby version will find new methods added at runtime just as easily.



You don't have to write special command classes for `send`: it works on any object.

```
"John Coltrane".send(:length) → 13
"Miles Davis".send("sub", /iles/, '.') → "M. Davis"
```

Another way of invoking methods dynamically uses `Method` objects. A `Method` object is like a `Proc` object: it represents a chunk of code and a context in which it executes. In this case, the code is the body of the method, and the context is the object that created the method. Once we have our `Method` object, we can execute it sometime later by sending it the message `call`.

```
trane = "John Coltrane".method(:length)
miles = "Miles Davis".method("sub")

trane.call → 13
miles.call(/iles/, '.') → "M. Davis"
```

You can pass the `Method` object around as you would any other object, and when you invoke `Method#call`, the method is run just as if you had invoked it on the original object. It's like having a C-style function pointer but in a fully object-oriented style.

You can also use `Method` objects with iterators.

```
def double(a)
 2*a
end

mObj = method(:double)

[1, 3, 5, 7].collect(&mObj) → [2, 6, 10, 14]
```

## 1.8

`Method` objects are bound to one particular object. You can create *unbound* methods (of class `UnboundMethod`) and then subsequently bind them to one or more objects. The binding creates a new `Method` object. As with aliases, unbound methods are references to the definition of the method at the time they are created.

```
unbound_length = String.instance_method(:length)
class String
 def length
 99
 end
end
str = "cat"
str.length → 99
bound_length = unbound_length.bind(str)
bound_length.call → 3
```

As good things come in threes, here's yet another way to invoke methods dynamically. The `eval` method (and its variations such as `class_eval`, `module_eval`, and `instance_eval`) will parse and execute an arbitrary string of legal Ruby source code.

```

trane = %q{"John Coltrane".length}
miles = %q{"Miles Davis".sub(/iles/, '.')}

eval trane → 13
eval miles → "M. Davis"

```

When using `eval`, it can be helpful to state explicitly the context in which the expression should be evaluated, rather than using the current context. You can obtain a context by calling `Kernel#binding` at the desired point.

```

def get_a_binding
 val = 123
 binding
end

val = "cat"

the_binding = get_a_binding
eval("val", the_binding) → 123
eval("val") → "cat"

```

The first `eval` evaluates `val` in the context of the binding *as it was* as the method `get_a_binding` was executing. In this binding, the variable `val` had a value of 123. The second `eval` evaluates `val` in the toplevel binding, where it has the value "cat".

## Performance Considerations

As we've seen in this section, Ruby gives us several ways to invoke an arbitrary method of some object: `Object#send`, `Method#call`, and the various flavors of `eval`.

You may prefer to use any one of these techniques depending on your needs, but be aware that `eval` is significantly slower than the others (or, for optimistic readers, `send` and `call` are significantly faster than `eval`).

```

require 'benchmark'
include Benchmark

test = "Stormy Weather"
m = test.method(:length)
n = 100000

bm(12) {|x|
 x.report("call") { n.times { m.call } }
 x.report("send") { n.times { test.send(:length) } }
 x.report("eval") { n.times { eval "test.length" } }
}

```

*produces:*

	user	system	total	real
call	0.250000	0.000000	0.250000	( 0.340967)
send	0.210000	0.000000	0.210000	( 0.254237)
eval	1.410000	0.000000	1.410000	( 1.656809)

## System Hooks

A *hook* is a technique that lets you trap some Ruby event, such as object creation. The simplest hook technique in Ruby is to intercept calls to methods in system classes. Perhaps you want to log all the operating system commands your program executes. Simply rename the method `Kernel.system` and substitute it with one of your own that both logs the command and calls the original `Kernel` method.

```
module Kernel
 alias_method :old_system, :system
 def system(*args)
 result = old_system(*args)
 puts "system(#{args.join(', ')} returned #{result}"
 result
 end
end

system("date")
system("kangaroo", "-hop 10", "skippy")
```

*produces:*

```
Thu Aug 26 22:37:22 CDT 2004
system(date) returned true
system(kangaroo, -hop 10, skippy) returned false
```

A more powerful hook is catching objects as they are created. If you can be present when every object is born, you can do all sorts of interesting things: you can wrap them, add methods to them, remove methods from them, add them to containers to implement persistence, you name it. We'll show a simple example here: we'll add a time stamp to every object as it's created. First, we'll add a `timestamp` attribute to every object in the system. We can do this by hacking class `Object` itself.

```
class Object
 attr_accessor :timestamp
end
```

Then we need to hook object creation to add this time stamp. One way to do this is to do our method renaming trick on `Class#new`, the method that's called to allocate space for a new object. The technique isn't perfect—some built-in objects, such as literal strings, are constructed without calling `new`—but it'll work just fine for objects we write.

```
class Class
 alias_method :old_new, :new
 def new(*args)
 result = old_new(*args)
 result.timestamp = Time.now
 result
 end
end
```

Finally, we can run a test. We'll create a couple of objects a few milliseconds apart and check their time stamps.

```
class Test
end

obj1 = Test.new
sleep(0.002)
obj2 = Test.new

obj1.timestamp.to_f → 1093577843.1312
obj2.timestamp.to_f → 1093577843.14144
```

All this method renaming is fine, and it really does work, but be aware that it can cause problems. If a subclass does the same thing, and renames the methods using the same names, you'll end up with an infinite loop. You can avoid this by aliasing your methods to a unique symbol name or by using a consistent naming convention.

There are other, more refined ways to get inside a running program. Ruby provides several callback methods that let you trap certain events in a controlled way.

## Runtime Callbacks

You can be notified whenever one of the following events occurs.

Event	Callback Method
Adding an instance method	Module#method_added
<u>1.8</u> Removing an instance method	Module#method_removed
<u>1.8</u> Undefined an instance method	Module#method_undefined
Adding a singleton method	Kernel.singleton_method_added
<u>1.8</u> Removing a singleton method	Kernel.singleton_method_removed
<u>1.8</u> Undefined a singleton method	Kernel.singleton_method_undefined
Subclassing a class	Class#inherited
Mixing in a module	Module#extend_object

By default, these methods do nothing. If you define the callback method in your class, it'll be invoked automatically. The actual call sequences are illustrated in the library descriptions for each callback method.

Keeping track of method creation and class and module usage lets you build an accurate picture of the dynamic state of your program. This can be important. For example, you may have written code that wraps all the methods in a class, perhaps to add transactional support or to implement some form of delegation. This is only half the job: the dynamic nature of Ruby means that users of this class could add new methods to it at any time. Using these callbacks, you can write code that wraps these new methods as they are created.

## Tracing Your Program's Execution

While we're having fun reflecting on all the objects and classes in our programs, let's not forget about the humble statements that make our code actually do things. It turns out that Ruby lets us look at these statements, too.

First, you can watch the interpreter as it executes code. `set_trace_func` executes a Proc with all sorts of juicy debugging information whenever a new source line is executed, methods are called, objects are created, and so on. You'll find a full description on page 508, but here's a taste.

```
class Test
 def test
 a = 1
 b = 2
 end
end

set_trace_func proc {|event, file, line, id, binding, classname|
 printf "%8s %s:%-2d %10s %8s\n", event, file, line, id, classname
}
t = Test.new
t.test
```

*produces:*

```
 line prog.rb:11 false
c-call prog.rb:11 new Class
c-call prog.rb:11 initialize Object
c-return prog.rb:11 initialize Object
c-return prog.rb:11 new Class
 line prog.rb:12 false
 call prog.rb:2 test Test
 line prog.rb:3 test Test
 line prog.rb:4 test Test
return prog.rb:4 test Test
```

The method `trace_var` (described on page 511) lets you add a hook to a global variable; whenever an assignment is made to the global, your Proc object is invoked.

## How Did We Get Here?

A fair question, and one we ask ourselves regularly. Mental lapses aside, in Ruby at least you can find out exactly “how you got there” by using the method `caller`, which returns an Array of String objects representing the current call stack.

```
def cat_a
 puts caller.join("\n")
end
def cat_b
 cat_a
end
```

```

def cat_c
 cat_b
end
cat_c

```

*produces:*

```

prog.rb:5:in `cat_b'
prog.rb:8:in `cat_c'
prog.rb:10

```

Once you've figured out how you got there, where you go next is up to you.

## Source Code

Ruby executes programs from plain old files. You can look these files to examine the source code that makes up your program using one of a number of techniques.

The special variable `__FILE__` contains the name of the current source file. This leads to a fairly short (if cheating) Quine—a program that outputs its own source code.

```
print File.read(__FILE__)
```

The method `Kernel.caller` returns the call stack—the list of stack frames in existence at the time the method was called. Each entry in this list starts off with a filename, a colon, and a line number in that file. You can parse this information to display source. In the following example, we have a main program, `main.rb`, that calls a method in a separate file, `sub.rb`. That method in turn invokes a block, where we traverse the call stack and write out the source lines involved. Notice the use of a hash of file contents, indexed by the filename.

Here's the code that dumps out the call stack, including source information.

```

def dump_call_stack
 file_contents = {}
 puts "File Line Source Line"
 puts "-----+-----+-----"
 caller.each do |position|
 next unless position =~ /\A(.?):(\d+)/
 file = $1
 line = Integer($2)
 file_contents[file] ||= File.readlines(file)
 printf("%-25s:%3d - %s", file, line,
 file_contents[file][line-1].lstrip)
 end
end

```

The (trivial) file `sub.rb` contains a single method.

```

def sub_method(v1, v2)
 main_method(v1*3, v2*6)
end

```

And here's the main program, which invokes the stack dumper after being called back by the submethod.

```
require 'sub'
require 'stack_dumper'
def main_method(arg1, arg2)
 dump_call_stack
end
sub_method(123, "cat")
```

*produces:*

File	Line	Source Line
code/caller/main.rb	: 5	- dump_call_stack
./code/caller/sub.rb	: 2	- main_method(v1*3, v2*6)
code/caller/main.rb	: 8	- sub_method(123, "cat")

The `SCRIPT_LINES__` constant is closely related to this technique. If a program initializes a constant called `SCRIPT_LINES__` with a hash, that hash will receive the source code of every file subsequently loaded into the interpreter using `require` or `load`. See `Kernel.require` on page 507 for an example.

## Marshaling and Distributed Ruby

Java features the ability to *serialize* objects, letting you store them somewhere and reconstitute them when needed. You can use this facility, for instance, to save a tree of objects that represent some portion of application state—a document, a CAD drawing, a piece of music, and so on.

Ruby calls this kind of serialization *marshaling* (think of railroad marshaling yards where individual cars are assembled in sequence into a complete train, which is then dispatched somewhere). Saving an object and some or all of its components is done using the method `Marshal.dump`. Typically, you will dump an entire object tree starting with some given object. Later, you can reconstitute the object using `Marshal.load`.

Here's a short example. We have a class `Chord` that holds a collection of musical notes. We'd like to save away a particularly wonderful chord so we can e-mail it to a couple of hundred of our closest friends. They can then load it into their copy of Ruby and savor it too. Let's start with the classes for `Note` and `Chord`.

```
Note = Struct.new(:value)
class Note
 def to_s
 value.to_s
 end
end
```

```

class Chord
 def initialize(arr)
 @arr = arr
 end
 def play
 @arr.join('-')
 end
end

```

Now we'll create our masterpiece and use `Marshal.dump` to save a serialized version of it to disk.

```

c = Chord.new([Note.new("G"),
 Note.new("Bb"),
 Note.new("Db"),
 Note.new("E")])
File.open("posterity", "w+") do |f|
 Marshal.dump(c, f)
end

```

Finally, our grandchildren read it in and are transported by our creation's beauty.

```

File.open("posterity") do |f|
 chord = Marshal.load(f)
end

chord.play → "G-Bb-Db-E"

```

## Custom Serialization Strategy

Not all objects can be dumped: bindings, procedure objects, instances of class IO, and singleton objects cannot be saved outside the running Ruby environment (a `TypeError` will be raised if you try). Even if your object doesn't contain one of these problematic objects, you may want to take control of object serialization yourself.

1.8

`Marshal` provides the hooks you need. In the objects that require custom serialization, simply implement two instance methods: one called `marshal_dump`, which writes the object out to a string, and one called `marshal_load`, which reads a string that you'd previously created and uses it to initialize a newly allocated object. (In earlier Ruby versions you'd use methods called `_dump` and `_load`, but the new versions play better with Ruby 1.8's new allocation scheme.) The instance method `marshal_dump` should return an object representing the state to be dumped. When the object is subsequently reconstituted using `Marshal.load`, the method `marshal_load` will be called with this object and will use it to set the state of its receiver—it will be run in the context of an allocated but not initialized object of the class being loaded.

For instance, here is a sample class that defines its own serialization. For whatever reasons, `Special` doesn't want to save one of its internal data members, `@volatile`. The author has decided to serialize the two other instance variables in an array.



```

class Special
 def initialize(valuable, volatile, precious)
 @valuable = valuable
 @volatile = volatile
 @precious = precious
 end
 def marshal_dump
 [@valuable, @precious]
 end
 def marshal_load(variables)
 @valuable = variables[0]
 @precious = variables[1]
 @volatile = "unknown"
 end
 def to_s
 "#@valuable #@volatile #@precious"
 end
end

obj = Special.new("Hello", "there", "World")
puts "Before: obj = #{obj}"
data = Marshal.dump(obj)
obj = Marshal.load(data)
puts "After: obj = #{obj}"

```

*produces:*

```

Before: obj = Hello there World
After: obj = Hello unknown World

```

For more details, see the reference section on Marshal beginning on page 514.

## 1.8 YAML for Marshaling

The Marshal module is built into the interpreter and uses a binary format to store objects externally. While fast, this binary format has one major disadvantage: if the interpreter changes significantly, the marshal binary format may also change, and old dumped files may no longer be loadable.

An alternative is to use a less fussy external format, preferably one using text rather than binary files. One option, supplied as a standard library as of Ruby 1.8, is YAML.<sup>2</sup>

We can adapt our previous marshal example to use YAML. Rather than implement specific loading and dumping methods to control the marshal process, we simply define the method `to_yaml_properties`, which returns a list of instance variables to be saved.

---

2. <http://www.yaml.org>. YAML stands for YAML Ain't Markup Language, but that hardly seems important.

```

require 'yaml'
class Special
 def initialize(valuable, volatile, precious)
 @valuable = valuable
 @volatile = volatile
 @precious = precious
 end
 def to_yaml_properties
 %w{ @precious @valuable }
 end
 def to_s
 "#@valuable #@volatile #@precious"
 end
end
obj = Special.new("Hello", "there", "World")
puts "Before: obj = #{obj}"
data = YAML.dump(obj)
obj = YAML.load(data)
puts "After: obj = #{obj}"

```

*produces:*

```

Before: obj = Hello there World
After: obj = Hello World

```

We can have a look at what YAML creates as the serialized form of the object—it's pretty simple.

```

obj = Special.new("Hello", "there", "World")
puts YAML.dump(obj)

```

*produces:*

```

--- !ruby/object:Special
precious: World
valuable: Hello

```

## Distributed Ruby

Since we can serialize an object or a set of objects into a form suitable for out-of-process storage, we can use this capability for the *transmission* of objects from one process to another. Couple this capability with the power of networking, and *voilà*: you have a distributed object system. To save you the trouble of having to write the code, we suggest using Masatoshi Seki's Distributed Ruby library (drb), which is now available as a standard Ruby library.

1.8

Using drb, a Ruby process may act as a server, as a client, or as both. A drb server acts as a source of objects, while a client is a user of those objects. To the client, it appears that the objects are local, but in reality the code is still being executed remotely.

A server starts a service by associating an object with a given port. Threads are created internally to handle incoming requests on that port, so remember to join the drb thread before exiting your program.

```
require 'drb'
class TestServer
 def add(*args)
 args.inject {|n,v| n + v}
 end
end
server = TestServer.new
DRb.start_service('druby://localhost:9000', server)
DRb.thread.join # Don't exit just yet!
```

A simple drb client simply creates a local drb object and associates it with the object on the remote server; the local object is a proxy.

```
require 'drb'
DRb.start_service()
obj = DRbObject.new(nil, 'druby://localhost:9000')
Now use obj
puts "Sum is: #{obj.add(1, 2, 3)}"
```

The client connects to the server and calls the method `add`, which uses the magic of `inject` to sum its arguments. It returns the result, which the client prints out.

```
Sum is: 6
```

The initial `nil` argument to `DRbObject` indicates that we want to attach to a new distributed object. We could also use an existing object.

Ho hum, you say. This sounds like Java's RMI, or CORBA, or whatever. Yes, it is a functional distributed object mechanism—but it is written in just a few hundred lines of Ruby code. No C, nothing fancy, just plain old Ruby code. Of course, it has no naming service or trader service, or anything like you'd see in CORBA, but it is simple and reasonably fast. On 1GHz Powerbook system, this sample code runs at about 500 remote message calls per second.

And, if you like the look of Sun's JavaSpaces, the basis of the JINI architecture, you'll be interested to know that drb is distributed with a short module that does the same kind of thing. JavaSpaces is based on a technology called Linda. To prove that its Japanese author has a sense of humor, Ruby's version of Linda is known as *Rinda*.

## 1.8

If you like your remote messaging fat, dumb, and interoperable, you could also look into the SOAP libraries distributed with Ruby.<sup>3</sup>

---

3. This is a comment on SOAP, which long-ago abandoned the *Simple* part of its acronym. The Ruby implementation of SOAP is a wonderful piece of work.

## Compile Time? Runtime? Anytime!

The important thing to remember about Ruby is that there isn't a big difference between "compile time" and "runtime." It's all the same. You can add code to a running process. You can redefine methods on the fly, change their scope from `public` to `private`, and so on. You can even alter basic types, such as `Class` and `Object`.

Once you get used to this flexibility, it is hard to go back to a static language such as C++ or even to a half-static language such as Java.

But then, why would you want to do that?

---

## Part IV

# Ruby Library Reference

---

# Built-in Classes and Modules

---

This chapter documents the classes and modules built into the standard Ruby language. They are available to every Ruby program automatically; no `require` is required. This section does not contain the various predefined variables and constants; these are listed starting on page 318.

In the descriptions starting on page 406, we show sample invocations for each method.

---

**new** `String.new( some_string ) → new_string`

---

This description shows a class method that is called as `String.new`. The italic parameter indicates that a single string is passed in, and the arrow indicates that another string is returned from the method. Because this return value has a different name than that of the parameter, it represents a different object.

When we illustrate instance methods, we show a sample call with a dummy object name in italics as the receiver.

---

**each** `str.each( sep=$/ ) { |record| block } → str`

---

The parameter to `String#each` is shown to have a default value; call `each` with no parameter, and the value of `$/` will be used. This method is an iterator, so the call is followed by a block. `String#each` returns its receiver, so the receiver's name (*str* in this case) appears again after the arrow.

Some methods have optional parameters. We show these parameters between angle brackets, `< xxx >`. (Additionally, we use the notation `< xxx >*` to indicate zero or more occurrences of `xxx` and use `< xxx >+` to indicate one or more occurrences of `xxx`.)

---

**index** `self.index( str < , offset > ) → pos or nil`

---

Finally, for methods that can be called in several different forms, we list each form on a separate line.

# Alphabetical Listing

Standard classes are listed alphabetically, followed by the standard modules. Within each, we list the class (or module) methods, followed by its instance methods.

## Summary of Built-in Classes

**Array** (page 406): *Class:* [], new. *Instance:* &, \*, +, -, <<, <=>, ==, [], []=, |, assoc, at, clear, collect!, compact, compact!, concat, delete, delete\_at, delete\_if, each, each\_index, empty?, eql?, fetch, fill, first, flatten, flatten!, include?, index, indexes, indices, insert, join, last, length, map!, nitens, pack, pop, push, rassoc, reject!, replace, reverse, reverse!, reverse\_each, rindex, shift, size, slice, slice!, sort, sort!, to\_a, to\_ary, to\_s, transpose, uniq, uniq!, unshift, values\_at.

**Bignum** (page 420): *Instance:* Arithmetic operations, Bit operations, <=>, ==, [], abs, div, divmod, eql?, modulo, quo, remainder, size, to\_f, to\_s.

**Binding** (page 423)

**Class** (page 424): *Class:* inherited, new. *Instance:* allocate, new, superclass.

**Continuation** (page 427): *Instance:* call.

**Dir** (page 428): *Class:* [], chdir, chroot, delete, entries, foreach, getwd, glob, mkdir, new, open, pwd, rmdir, unlink. *Instance:* close, each, path, pos, pos=, read, rewind, seek, tell.

**Exception** (page 440): *Class:* exception, new. *Instance:* backtrace, exception, message, set\_backtrace, status, success?, to\_s, to\_str.

**FalseClass** (page 443): *Instance:* &, ^, |.

**File** (page 444): *Class:* atime, basename, blockdev?, chardev?, chmod, chown, ctime, delete, directory?, dirname, executable?, executable\_real?, exist?, exists?, expand\_path, extname, file?, fnmatch, fnmatch?, ftype, grpowned?, join, lchmod, lchown, link, lstat, mtime, new, open, owned?, pipe?, readable?, readable\_real?, readlink, rename, setgid?, setuid?, size, size?, socket?, split, stat, sticky?, symlink, symlink?, truncate, umask, unlink, utime, writable?, writable\_real?, zero?. *Instance:* atime, chmod, chown, ctime, flock, lchmod, lchown, lstat, mtime, path, truncate.

**File::Stat** (page 456): *Instance:* <=>, atime, blksize, blockdev?, blocks, chardev?, ctime, dev, dev\_major, dev\_minor, directory?, executable?, executable\_real?, file?, ftype, gid, grpowned?, ino, mode, mtime, nlink, owned?, pipe?, rdev, rdev\_major, rdev\_minor, readable?, readable\_real?, setgid?, setuid?, size, size?, socket?, sticky?, symlink?, uid, writable?, writable\_real?, zero?.

**Fixnum** (page 463): *Class:* . *Instance:* Arithmetic operations, Bit operations, <=>, [], abs, div, divmod, id2name, modulo, quo, size, to\_f, to\_s, to\_sym, zero?.

**Float** (page 466): *Instance:* Arithmetic operations, <=>, ==, abs, ceil, divmod, eql?, finite?, floor, infinite?, modulo, nan?, round, to\_f, to\_i, to\_int, to\_s, truncate, zero?.

**Hash** (page 471): *Class:* [], new. *Instance:* ==, [], []=, clear, default, default=, default\_proc, delete, delete\_if, each, each\_key, each\_pair, each\_value, empty?, fetch, has\_key?, has\_value?, include?, index, indexes, indices, invert, key?, keys, length, member?, merge, merge!, rehash, reject, reject!, replace, select, shift, size, sort, store, to\_a, to\_hash, to\_s, update, value?, values, values\_at.

**Integer** (page 480): *Instance:* ceil, chr, downto, floor, integer?, next, round, succ, times, to\_i, to\_int, truncate, upto.

**IO** (page 482): *Class:* for\_fd, foreach, new, open, pipe, popen, read, readlines, select, sysopen.  
*Instance:* <<, binmode, clone, close, close\_read, close\_write, closed?, each, each\_byte, each\_line, eof, eof?, fcntl, fileno, flush, fsync, getc, gets, ioctl, isatty, lineno, lineno=, pid, pos, pos=, print, printf, puts, read, readchar, readline, readlines, reopen, rewind, seek, stat, sync, sync=, sysread, sysseek, syswrite, tell, to\_i, to\_io, tty?, ungetc, write.

**MatchData** (page 516): *Instance:* [ ], begin, captures, end, length, offset, post\_match, pre\_match, select, size, string, to\_a, to\_s, values\_at.

**Method** (page 522): *Instance:* [ ], ==, arity, call, eql?, to\_proc, unbind.

**Module** (page 524): *Class:* constants, nesting, new. *Instance:* <, <=, >, >=, <=>, ==, ancestors, autoload, autoload?, class\_eval, class\_variables, clone, const\_defined?, const\_get, const\_missing, const\_set, constants, include?, included\_modules, instance\_method, instance\_methods, method\_defined?, module\_eval, name, private\_class\_method, private\_instance\_methods, private\_method\_defined?, protected\_instance\_methods, protected\_method\_defined?, public\_class\_method, public\_instance\_methods, public\_method\_defined?. *Private:* alias\_method, append\_features, attr, attr\_accessor, attr\_reader, attr\_writer, define\_method, extend\_object, extended, include, included, method\_added, method\_removed, method\_undefined, module\_function, private, protected, public, remove\_class\_variable, remove\_const, remove\_method, undef\_method.

**NilClass** (page 540): *Instance:* &, ^, |, nil?, to\_a, to\_f, to\_i, to\_s.

**Numeric** (page 541): *Instance:* +@, -@, <=>, abs, ceil, coerce, div, divmod, eql?, floor, integer?, modulo, nonzero?, quo, remainder, round, step, to\_int, truncate, zero?.

**Object** (page 546): *Instance:* ==, ===, =~, \_\_id\_\_, \_\_send\_\_, class, clone, display, dup, eql?, equal?, extend, freeze, frozen?, hash, id, initialize\_copy, inspect, instance\_eval, instance\_of?, instance\_variable\_get, instance\_variable\_set, instance\_variables, is\_a?, kind\_of?, method, method\_missing, methods, nil?, object\_id, private\_methods, protected\_methods, public\_methods, respond\_to?, send, singleton\_methods, taint, tainted?, to\_a, to\_s, type, untaint. *Private:* initialize, remove\_instance\_variable, singleton\_method\_added, singleton\_method\_removed, singleton\_method\_undefined.

**Proc** (page 559): *Class:* new. *Instance:* [ ], ==, arity, binding, call, to\_proc, to\_s.

**Process::Status** (page 570): *Instance:* ==, &, >>, coredump?, exited?, exitstatus, pid, signaled?, stopped?, success?, stopsig, termsig, to\_i, to\_int, to\_s.

**Range** (page 576): *Class:* new. *Instance:* ==, ===, begin, each, end, eql?, exclude\_end?, first, include?, last, member?, step.

**Regexp** (page 579): *Class:* compile, escape, last\_match, new, quote. *Instance:* ==, ===, =~, ~, casefold?, inspect, kcode, match, options, source, to\_s.

**String** (page 585): *Class:* new. *Instance:* %, \*, +, <<, <=>, ==, ===, =~, [ ], [ ]=, ~, capitalize, capitalize!, casecmp, center, chomp, chomp!, chop, chop!, concat, count, crypt, delete, delete!, downcase, downcase!, dump, each\_byte, each\_line, empty?, gsub, gsub!, hex, include?, index, insert, intern, length, ljust, lstrip, lstrip!, match, next, next!, oct, replace, reverse, reverse!, rindex, rjust, rstrip, rstrip!, scan, size, slice, slice!, split, squeeze, squeeze!, strip, strip!, sub, sub!, succ, succ!, sum, swapcase, swapcase!, to\_f, to\_i, to\_s, to\_str, to\_sym, tr, tr!, tr\_s, tr\_sl, unpack, upcase, upcase!, upto.

**Struct** (page 605): *Class:* new, new, [ ], members. *Instance:* ==, [ ], [ ]=, each, each\_pair, length, members, size, to\_a, values, values\_at.

**Struct::Tms** (page 609)



**Symbol** (page 610): *Class:* all\_symbols. *Instance:* id2name, inspect, to\_i, to\_int, to\_s, to\_sym.

**Thread** (page 612): *Class:* abort\_on\_exception, abort\_on\_exception=, critical, critical=, current, exit, fork, kill, list, main, new, pass, start, stop. *Instance:* [ ], [ ]=, abort\_on\_exception, abort\_on\_exception=, alive?, exit, group, join, keys, key?, kill, priority, priority=, raise, run, safe\_level, status, stop?, terminate, value, wakeup.

**ThreadGroup** (page 619): *Class:* new. *Instance:* add, enclose, enclosed?, freeze, list.

**Time** (page 621): *Class:* at, gm, local, mktime, new, now, times, utc. *Instance:* +, -, <=>, asctime, ctime, day, dst?, getgm, getlocal, getutc, gmt?, gmtime, gmt\_offset, gmtoff, hour, isdst, localtime, mday, min, mon, month, sec, strftime, to\_a, to\_f, to\_i, to\_s, tv\_sec, tv\_usec, usec, utc, utc?, utc\_offset, wday, yday, year, zone.

**TrueClass** (page 629): *Instance:* &, ^, |.

**UnboundMethod** (page 630): *Instance:* arity, bind.

## Summary of Built-in Modules

**Comparable** (page 426): *Instance:* Comparisons, between?.

**Enumerable** (page 433): *Instance:* all?, any?, collect, detect, each\_with\_index, entries, find, find\_all, grep, include?, inject, map, max, member?, min, partition, reject, select, sort, sort\_by, to\_a, zip.

**Errno** (page 439)

**FileTest** (page 462)

**GC** (page 470): *Class:* disable, enable, start. *Instance:* garbage\_collect.

**Kernel** (page 495): *Class:* Array, Float, Integer, String, ` (backquote), abort, at\_exit, autoload, autoload?, binding, block\_given?, callcc, caller, catch, chomp, chomp!, chop, chop!, eval, exec, exit, exit!, fail, fork, format, gets, global\_variables, gsub, gsub!, iterator?, lambda, load, local\_variables, loop, open, p, print, printf, proc, puts, puts, rand, readln, readlines, require, scan, select, set\_trace\_func, sleep, split, sprintf, srand, sub, sub!, syscall, system, test, throw, trace\_var, trap, untrace\_var, warn.

**Marshal** (page 514): *Class:* dump, load, restore.

**Math** (page 519): *Class:* acos, acosh, asin, asinh, atan, atanh, atan2, cos, cosh, erf, erfc, exp, frexp, hypot, ldexp, log, log10, sin, sinh, sqrt, tan, tanh.

**ObjectSpace** (page 557): *Class:* \_id2ref, define\_finalizer, each\_object, garbage\_collect, undefine\_finalizer.

**Process** (page 562): *Class:* abort, detach, egid, egid=, euid, euid=, exit, exit!, fork, getpgid, getpgrp, getpriority, gid, gid=, groups, groups=, initgroups, kill, maxgroups, maxgroups=, pid, ppid, setpgid, setpgrp, setpriority, setsid, times, uid, uid=, wait, waitall, wait2, waitpid, waitpid2.

**Process::GID** (page 568): *Class:* change\_privilege, eid, eid=, grant\_privilege, re\_exchange, re\_exchangeable?, rid, sid\_available?, switch.

**Process::Sys** (page 573): *Class:* getegid, geteuid, getgid, getuid, issetugid, setegid, seteuid, setgid, setregid, setresgid, setresuid, setreuid, setrgid, setruid, setuid.

**Process::UID** (page 575): *Class:* change\_privilege, eid, eid=, grant\_privilege, re\_exchange, re\_exchangeable?, rid, sid\_available?, switch.

**Signal** (page 583): *Class:* list, trap.

**Class** **Array** < Object

Arrays are ordered, integer-indexed collections of any object. Array indexing starts at 0, as in C or Java. A negative index is assumed to be relative to the end of the array; that is, an index of  $-1$  indicates the last element of the array,  $-2$  is the next to last element in the array, and so on.

**Mixes in****Enumerable:**

all?, any?, collect, detect, each\_with\_index, entries, find, find\_all, grep, include?, inject, map, max, member?, min, partition, reject, select, sort, sort\_by, to\_a, zip

**Class methods**

**[]** Array[ <obj>\* ] → *an\_array*

Returns a new array populated with the given objects. Equivalent to the operator form `Array.[](...)`.

```
Array.[](1, 'a', /^A/) → [1, "a", /^A/]
Array[1, 'a', /^A/] → [1, "a", /^A/]
[1, 'a', /^A/] → [1, "a", /^A/]
```

**new**

Array.new → *an\_array*

Array.new ( size=0, obj=nil ) → *an\_array*

Array.new( array ) → *an\_array*

Array.new( size ) { |i| block } → *an\_array*

1.8

Returns a new array. In the first form, the new array is empty. In the second it is created with *size* copies of *obj* (that is, *size* references to the same *obj*). The third form creates a copy of the array passed as a parameter (the array is generated by calling `to_ary` on the parameter). In the last form, an array of the given size is created. Each element in this array is calculated by passing the element's index to the given block and storing the return value.

1.8

```
Array.new → []
Array.new(2) → [nil, nil]
Array.new(5, "A") → ["A", "A", "A", "A", "A"]
```

# only one instance of the default object is created

```
a = Array.new(2, Hash.new)
a[0]['cat'] = 'feline'
a → [{"cat"=>"feline"}, {"cat"=>"feline"}]
a[1]['cat'] = 'Felix'
a → [{"cat"=>"Felix"}, {"cat"=>"Felix"}]
```

```

a = Array.new(2) { Hash.new } # Multiple instances
a[0]['cat'] = 'feline'
a → [{"cat"=>"feline"}, {}]

squares = Array.new(5) {|i| i*i}
squares → [0, 1, 4, 9, 16]

copy = Array.new(squares) # initialized by copying
squares[5] = 25
squares → [0, 1, 4, 9, 16, 25]
copy → [0, 1, 4, 9, 16]

```

## Instance methods

---

**&** *arr & other\_array → an\_array*

Set Intersection—Returns a new array containing elements common to the two arrays, with no duplicates. The rules for comparing elements are the same as for hash keys. If you need setlike behavior, see the library class `Set` on page 710.

```
[1, 1, 3, 5] & [1, 2, 3] → [1, 3]
```

---

**\*** *arr \* int → an\_array*  
*arr \* str → a\_string*

Repetition—With an argument that responds to `to_str`, equivalent to `arr.join(str)`. Otherwise, returns a new array built by concatenating `int` copies of `arr`.

```
[1, 2, 3] * 3 → [1, 2, 3, 1, 2, 3, 1, 2, 3]
[1, 2, 3] * "--" → "1--2--3"
```

---

**+** *arr + other\_array → an\_array*

Concatenation—Returns a new array built by concatenating the two arrays together to produce a third array.

```
[1, 2, 3] + [4, 5] → [1, 2, 3, 4, 5]
```

---

**-** *arr - other\_array → an\_array*

Array Difference—Returns a new array that is a copy of the original array, removing any items that also appear in `other_array`. If you need setlike behavior, see the library class `Set` on page 710.

```
[1, 1, 2, 2, 3, 3, 4, 5] - [1, 2, 4] → [3, 3, 5]
```

---

**<<** *arr << obj → arr*

Append—Pushes the given object on to the end of this array. This expression returns the array itself, so several appends may be chained together. See also `Array#push`.

```
[1, 2] << "c" << "d" << [3, 4] → [1, 2, "c", "d", [3, 4]]
```

---

`<=>` `arr <=> other_array → -1, 0, +1`

Comparison—Returns an integer `-1`, `0`, or `+1` if this array is less than, equal to, or greater than `other_array`. Each object in each array is compared (using `<=>`). If any value isn't equal, then that inequality is the return value. If all the values found are equal, then the return is based on a comparison of the array lengths. Thus, two arrays are “equal” according to `Array#<=>` if and only if they have the same length and the value of each element is equal to the value of the corresponding element in the other array.

```
["a", "a", "c"] <=> ["a", "b", "c"] → -1
[1, 2, 3, 4, 5, 6] <=> [1, 2] → 1
```

---

`==` `arr == obj → true or false`

Equality—Two arrays are equal if they contain the same number of elements and if each element is equal to (according to `Object#==`) the corresponding element in the other array. If `obj` is not an array, attempt to convert it using `to_ary` and return `obj==arr`.

```
["a", "c"] == ["a", "c", 7] → false
["a", "c", 7] == ["a", "c", 7] → true
["a", "c", 7] == ["a", "d", "f"] → false
```

---

`[]` `arr[int] → obj or nil`  
`arr[start, length] → an_array or nil`  
`arr[range] → an_array or nil`

Element Reference—Returns the element at index `int`, returns a subarray starting at index `start` and continuing for `length` elements, or returns a subarray specified by `range`. Negative indices count backward from the end of the array (`-1` is the last element).

1.8

Returns `nil` if the index of the first element selected is greater than the array size. If the start index equals the array size and a `length` or `range` parameter is given, an empty array is returned. Equivalent to `Array#slice`.

```
a = ["a", "b", "c", "d", "e"]
a[2] + a[0] + a[1] → "cab"
a[6] → nil
a[1, 2] → ["b", "c"]
a[1..3] → ["b", "c", "d"]
a[4..7] → ["e"]
a[6..10] → nil
a[-3, 3] → ["c", "d", "e"]
```

```
special cases
a[5] → nil
a[5, 1] → []
a[5..10] → []
```

---

**[ ]=** *arr[int] = obj* → *obj*  
*arr[start, length] = obj* → *obj*  
*arr[range] = obj* → *obj*

---

Element Assignment—Sets the element at index *int*, replaces a subarray starting at index *start* and continuing for *length* elements, or replaces a subarray specified by *range*. If *int* is greater than the current capacity of the array, the array grows automatically. A negative *int* will count backward from the end of the array. Inserts elements if *length* is zero. If *obj* is `nil`, deletes elements from *arr*. If *obj* is an array, the form with the single index will insert that array into *arr*, and the forms with a length or with a range will replace the given elements in *arr* with the array contents. An `IndexError` is raised if a negative index points past the beginning of the array. See also `Array#push` and `Array#unshift`.

```
a = Array.new → []
a[4] = "4"; a → [nil, nil, nil, nil, "4"]
a[0] = [1, 2, 3]; a → [[1, 2, 3], nil, nil, nil, "4"]
a[0, 3] = ['a', 'b', 'c']; a → ["a", "b", "c", nil, "4"]
a[1..2] = [1, 2]; a → ["a", 1, 2, nil, "4"]
a[0, 2] = "?"; a → ["?", 2, nil, "4"]
a[0..2] = "A"; a → ["A", "4"]
a[-1] = "Z"; a → ["A", "Z"]
a[1..-1] = nil; a → ["A"]
```

---

*arr | other\_array* → *an\_array*

---

Set Union—Returns a new array by joining this array with *other\_array*, removing duplicates. The rules for comparing elements are the same as for hash keys. If you need setlike behavior, see the library class `Set` on page 710.

```
["a", "b", "c"] | ["c", "d", "a"] → ["a", "b", "c", "d"]
```

---

**assoc** *arr.assoc( obj )* → *an\_array* or *nil*

---

Searches through an array whose elements are also arrays comparing *obj* with the first element of each contained array using *obj*.`==`. Returns the first contained array that matches (that is, the first *associated* array) or `nil` if no match is found. See also `Array#rassoc`.

```
s1 = ["colors", "red", "blue", "green"]
s2 = ["letters", "a", "b", "c"]
s3 = "foo"
a = [s1, s2, s3]
a.assoc("letters") → ["letters", "a", "b", "c"]
a.assoc("foo") → nil
```

---

**at** *arr.at( int )* → *obj* or *nil*

---

Returns the element at index *int*. A negative index counts from the end of *arr*. Returns

`nil` if the index is out of range. See also `Array#[ ]`. (`Array#at` is slightly faster than `Array#[ ]`, as it does not accept ranges, and so on.)

```
a = ["a", "b", "c", "d", "e"]
a.at(0) → "a"
a.at(-1) → "e"
```

---

**clear** `arr.clear` → `arr`

---

Removes all elements from `arr`.

```
a = ["a", "b", "c", "d", "e"]
a.clear → []
```

---

**collect!** `arr.collect! { |obj| block }` → `arr`

---

Invokes `block` once for each element of `arr`, replacing the element with the value returned by `block`. See also `Enumerable#collect`.

```
a = ["a", "b", "c", "d"]
a.collect! { |x| x + "!" } → ["a!", "b!", "c!", "d!"]
a → ["a!", "b!", "c!", "d!"]
```

---

**compact** `arr.compact` → `an_array`

---

Returns a copy of `arr` with all `nil` elements removed.

```
["a", nil, "b", nil, "c", nil].compact → ["a", "b", "c"]
```

---

**compact!** `arr.compact!` → `arr` or `nil`

---

Removes `nil` elements from `arr`. Returns `nil` if no changes were made.

```
["a", nil, "b", nil, "c"].compact! → ["a", "b", "c"]
["a", "b", "c"].compact! → nil
```

---

**concat** `arr.concat( other_array )` → `arr`

---

Appends the elements in `other_array` to `arr`.

```
["a", "b"].concat(["c", "d"]) → ["a", "b", "c", "d"]
```

---

**delete** `arr.delete( obj )` → `obj` or `nil`  
`arr.delete( obj ) { block }` → `obj` or `nil`

---

Deletes items from `arr` that are equal to `obj`. If the item is not found, returns `nil`. If the optional code block is given, returns the result of `block` if the item is not found.

```
a = ["a", "b", "b", "b", "c"]
a.delete("b") → "b"
a → ["a", "c"]
a.delete("z") → nil
a.delete("z") { "not found" } → "not found"
```

---

**delete\_at** *arr.delete\_at( index ) → obj or nil*

---

Deletes the element at the specified index, returning that element, or `nil` if the index is out of range. See also `Array#slice!`.

```
a = %w(ant bat cat dog)
a.delete_at(2) → "cat"
a → ["ant", "bat", "dog"]
a.delete_at(99) → nil
```

---

**delete\_if** *arr.delete\_if { |item| block } → arr*

---

Deletes every element of *arr* for which *block* evaluates to true.

```
a = ["a", "b", "c"]
a.delete_if { |x| x >= "b" } → ["a"]
```

---

**each** *arr.each { |item| block } → arr*

---

Calls *block* once for each element in *arr*, passing that element as a parameter.

```
a = ["a", "b", "c"]
a.each { |x| print x, " -- " }
```

*produces:*

```
a -- b -- c --
```

---

**each\_index** *arr.each\_index { |index| block } → arr*

---

Same as `Array#each` but passes the index of the element instead of the element itself.

```
a = ["a", "b", "c"]
a.each_index { |x| print x, " -- " }
```

*produces:*

```
0 -- 1 -- 2 --
```

---

**empty?** *arr.empty? → true or false*

---

Returns true if *arr* array contains no elements.

```
[].empty? → true
[1, 2, 3].empty? → false
```

---

**eql?** *arr.eql?( other ) → true or false*

---

Returns true if *arr* and *other* are the same object or if *other* is an object of class `Array` with the same length and content as *arr*. Elements in the arrays are compared using `Object#eql?`. See also `Array#<=>`.

```
["a", "b", "c"].eql?(["a", "b", "c"]) → true
["a", "b", "c"].eql?(["a", "b"]) → false
["a", "b", "c"].eql?(["b", "c", "d"]) → false
```

**fetch**

*arr.fetch(index) → obj*  
*arr.fetch(index, default) → obj*  
*arr.fetch(index) {|i| block } → obj*

1.8 Tries to return the element at position *index*. If the index lies outside the array, the first form throws an `IndexError` exception, the second form returns *default*, and the third form returns the value of invoking the block, passing in the index. Negative values of *index* count from the end of the array.

```
a = [11, 22, 33, 44]
a.fetch(1) → 22
a.fetch(-1) → 44
a.fetch(-1, 'cat') → 44
a.fetch(4, 'cat') → "cat"
a.fetch(4) {|i| i*i } → 16
```

**fill**

*arr.fill(obj) → arr*  
*arr.fill(obj, start ⟨, length⟩) → arr*  
*arr.fill(obj, range) → arr*  
*arr.fill {|i| block } → arr*  
*arr.fill(start ⟨, length⟩) {|i| block } → arr*  
*arr.fill(range) {|i| block } → arr*

The first three forms set the selected elements of *arr* (which may be the entire array) to *obj*. A *start* of `nil` is equivalent to zero. A *length* of `nil` is equivalent to *arr.length*.

1.8 The last three forms fill the array with the value of the block. The block is passed the absolute index of each element to be filled.

```
a = ["a", "b", "c", "d"]
a.fill("x") → ["x", "x", "x", "x"]
a.fill("z", 2, 2) → ["x", "x", "z", "z"]
a.fill("y", 0..1) → ["y", "y", "z", "z"]
a.fill {|i| i*i} → [0, 1, 4, 9]
a.fill(-3) {|i| i+100} → [0, 101, 102, 103]
```

**first**

*arr.first → obj or nil*  
*arr.first(count) → an\_array*

1.8 Returns the first element, or the first *count* elements, of *arr*. If the array is empty, the first form returns `nil`, and the second returns an empty array.

```
a = ["q", "r", "s", "t"]
a.first → "q"
a.first(1) → ["q"]
a.first(3) → ["q", "r", "s"]
```

**flatten**

*arr.flatten → an\_array*

Returns a new array that is a one-dimensional flattening of this array (recursively). That is, for every element that is an array, extract its elements into the new array.



```
s = [1, 2, 3] → [1, 2, 3]
t = [4, 5, 6, [7, 8]] → [4, 5, 6, [7, 8]]
a = [s, t, 9, 10] → [[1, 2, 3], [4, 5, 6, [7, 8]], 9, 10]
a.flatten → [1, 2, 3, 4, 5, 6, 7, 8, 9, 10]
```

---

**flatten!** *arr.flatten!* → *arr* or *nil*

---

Same as `Array#flatten` but modifies the receiver in place. Returns `nil` if no modifications were made (i.e., *arr* contains no subarrays).

```
a = [1, 2, [3, [4, 5]]]
a.flatten! → [1, 2, 3, 4, 5]
a.flatten! → nil
a → [1, 2, 3, 4, 5]
```

---

**include?** *arr.include?(obj)* → *true* or *false*

---

Returns `true` if the given object is present in *arr* (that is, if any object == *obj*), `false` otherwise.

```
a = ["a", "b", "c"]
a.include?("b") → true
a.include?("z") → false
```

---

**index** *arr.index(obj)* → *int* or *nil*

---

Returns the index of the first object in *arr* that is == to *obj*. Returns `nil` if no match is found.

```
a = ["a", "b", "c"]
a.index("b") → 1
a.index("z") → nil
```

---

**indexes** *arr.indexes(i1, i2, ... iN)* → *an\_array*

---

1.8 Deprecated; use `Array#values_at`.

---

**indices** *arr.indices(i1, i2, ... iN)* → *an\_array*

---

1.8 Deprecated; use `Array#values_at`.

---

**insert** *arr.insert(index, <obj>+)* → *arr*

---

1.8 If *index* is not negative, inserts the given values before the element with the given index. If *index* is `-1`, appends the values to *arr*. Otherwise inserts the values after the element with the given index.

```
a = %w{ a b c d }
a.insert(2, 99) → ["a", "b", 99, "c", "d"]
a.insert(-2, 1, 2, 3) → ["a", "b", 99, "c", 1, 2, 3, "d"]
a.insert(-1, "e") → ["a", "b", 99, "c", 1, 2, 3, "d", "e"]
```

Table 27.1. Template characters for Array#pack

Directive	Meaning
@	Moves to absolute position
A	ASCII string (space padded, count is width)
a	ASCII string (null padded, count is width)
B	Bit string (descending bit order)
b	Bit string (ascending bit order)
C	Unsigned char
c	Char
D, d	Double-precision float, native format
E	Double-precision float, little-endian byte order
e	Single-precision float, little-endian byte order
F, f	Single-precision float, native format
G	Double-precision float, network (big-endian) byte order
g	Single-precision float, network (big-endian) byte order
H	Hex string (high nibble first)
h	Hex string (low nibble first)
I	Unsigned integer
i	Integer
L	Unsigned long
l	Long
M	Quoted printable, MIME encoding (see RFC2045)
m	Base64 encoded string
N	Long, network (big-endian) byte order
n	Short, network (big-endian) byte order
P	Pointer to a structure (fixed-length string)
p	Pointer to a null-terminated string
<u>1.8</u> Q, q	64-bit number
S	Unsigned short
s	Short
U	UTF-8
u	UU-encoded string
V	Long, little-endian byte order
v	Short, little-endian byte order
<u>1.8</u> w	BER-compressed integer <sup>1</sup>
X	Back up a byte
x	Null byte
Z	Same as A

<sup>1</sup> The octets of a BER-compressed integer represent an unsigned integer in base 128, most significant digit first, with as few digits as possible. Bit eight (the high bit) is set on each byte except the last (*Self-Describing Binary Data Representation*, MacLeod)

---

**join** *arr.join( separator=\$, ) → str*

---

Returns a string created by concatenating each element of the array to a string, separating each by *separator*.

```
["a", "b", "c"].join → "abc"
["a", "b", "c"].join("-") → "a-b-c"
```

---

**last** *arr.last → obj or nil*  
*arr.last( count ) → an\_array*

---

1.8 Returns the last element, or last *count* elements, of *arr*. If the array is empty, the first form returns *nil*, the second an empty array.

```
["w", "x", "y", "z"].last → "z"
["w", "x", "y", "z"].last(1) → ["z"]
["w", "x", "y", "z"].last(3) → ["x", "y", "z"]
```

---

**length** *arr.length → int*

---

Returns the number of elements in *arr*. See also `Array#nitems`.

```
[1, nil, 3, nil, 5].length → 5
```

---

**map!** *arr.map! { |obj| block } → arr*

---

Synonym for `Array#collect!`.

---

**nitems** *arr.nitems → int*

---

Returns the number of non-*nil* elements in *arr*. See also `Array#length`.

```
[1, nil, 3, nil, 5].nitems → 3
```

---

**pack** *arr.pack ( template ) → binary\_string*

---

1.8 Packs the contents of *arr* into a binary sequence according to the directives in *template* (see Table 27.1 on the page before). Directives A, a, and Z may be followed by a count, which gives the width of the resulting field. The remaining directives also may take a count, indicating the number of array elements to convert. If the count is an asterisk (\*), all remaining array elements will be converted. Any of the directives “sSiILL” may be followed by an underscore (\_) to use the underlying platform’s native size for the specified type; otherwise, they use a platform-independent size. Spaces are ignored in the template string. Comments starting with # to the next newline or end of string are also ignored. See also `String#unpack` on page 602.

```
a = ["a", "b", "c"]
n = [65, 66, 67]
a.pack("A3A3A3") → "a__b__c__"
a.pack("a3a3a3") → "a\000\000b\000\000c\000\000"
n.pack("ccc") → "ABC"
```

---

**pop** *arr.pop* → *obj* or *nil*

---

Removes the last element from *arr* and returns it or returns *nil* if the array is empty.

```
a = ["a", "m", "z"]
a.pop → "z"
a → ["a", "m"]
```

---

**push** *arr.push( <obj>\* )* → *arr*

---

Appends the given argument(s) to *arr*.

```
a = ["a", "b", "c"]
a.push("d", "e", "f") → ["a", "b", "c", "d", "e", "f"]
```

---

**rassoc** *arr.rassoc( key )* → *an\_array* or *nil*

---

Searches through the array whose elements are also arrays. Compares *key* with the second element of each contained array using `==`. Returns the first contained array that matches. See also `Array#assoc`.

```
a = [[1, "one"], [2, "two"], [3, "three"], ["ii", "two"]]
a.rassoc("two") → [2, "two"]
a.rassoc("four") → nil
```

---

**reject!** *arr.reject! { block } item* → *arr* or *nil*

---

Equivalent to `Array#delete_if`, but returns *nil* if no changes were made. Also see `Enumerable#reject`.

---

**replace** *arr.replace( other\_array )* → *arr*

---

Replaces the contents of *arr* with the contents of *other\_array*, truncating or expanding if necessary.

```
a = ["a", "b", "c", "d", "e"]
a.replace(["x", "y", "z"]) → ["x", "y", "z"]
a → ["x", "y", "z"]
```

---

**reverse** *arr.reverse* → *an\_array*

---

Returns a new array using *arr*'s elements in reverse order.

```
["a", "b", "c"].reverse → ["c", "b", "a"]
[1].reverse → [1]
```

---

**reverse!** *arr.reverse!* → *arr*

---

1.8 Reverses *arr* in place.

```
a = ["a", "b", "c"]
a.reverse! → ["c", "b", "a"]
a → ["c", "b", "a"]
[1].reverse! → [1]
```

---

**reverse\_each** *arr.reverse\_each { |item| block } → arr*

---

Same as `Array#each`, but traverses *arr* in reverse order.

```
a = ["a", "b", "c"]
a.reverse_each { |x| print x, " " }
```

*produces:*

```
c b a
```

---

**rindex** *arr.rindex( obj ) → int or nil*

---

Returns the index of the last object in *arr* such that the object == *obj*. Returns `nil` if no match is found.

```
a = ["a", "b", "b", "b", "c"]
a.rindex("b") → 3
a.rindex("z") → nil
```

---

**shift** *arr.shift → obj or nil*

---

Returns the first element of *arr* and removes it (shifting all other elements down by one). Returns `nil` if the array is empty.

```
args = ["-m", "-q", "filename"]
args.shift → "-m"
args → ["-q", "filename"]
```

---

**size** *arr.size → int*

---

Synonym for `Array#length`.

---

**slice** *arr.slice( int ) → obj*  
*arr.slice( start, length ) → an\_array*  
*arr.slice( range ) → an\_array*

---

Synonym for `Array#[ ]`.

```
a = ["a", "b", "c", "d", "e"]
a.slice(2) + a.slice(0) + a.slice(1) → "cab"
a.slice(6) → nil
a.slice(1, 2) → ["b", "c"]
a.slice(1..3) → ["b", "c", "d"]
a.slice(4..7) → ["e"]
a.slice(6..10) → nil
a.slice(-3, 3) → ["c", "d", "e"]
special cases
a.slice(5) → nil
a.slice(5, 1) → []
a.slice(5..10) → []
```

**slice!**

*arr.slice!( int )* → *obj* or *nil*  
*arr.slice!( start, length )* → *an\_array* or *nil*  
*arr.slice!( range )* → *an\_array* or *nil*

Deletes the element(s) given by an index (optionally with a length) or by a range. Returns the deleted object, subarray, or *nil* if the index is out of range. Equivalent to

```
def slice!(*args)
 result = self[*args]
 self[*args] = nil
 result
end

a = ["a", "b", "c"]
a.slice!(1) → "b"
a → ["a", "c"]
a.slice!(-1) → "c"
a → ["a"]
a.slice!(100) → nil
a → ["a"]
```

**sort**

*arr.sort* → *an\_array*  
*arr.sort { |a,b| block }* → *an\_array*

Returns a new array created by sorting *arr*. Comparisons for the sort will be done using the `<=>` operator or using an optional code block. The block implements a comparison between *a* and *b*, returning `-1`, `0`, or `+1`. See also `Enumerable#sort_by`.

```
a = ["d", "a", "e", "c", "b"]
a.sort → ["a", "b", "c", "d", "e"]
a.sort { |x,y| y <=> x } → ["e", "d", "c", "b", "a"]
```

**sort!**

*arr.sort!* → *arr*  
*arr.sort! { |a,b| block }* → *arr*

Sorts *arr* in place (see `Array#sort`). *arr* is effectively frozen while a sort is in progress.

```
a = ["d", "a", "e", "c", "b"]
a.sort! → ["a", "b", "c", "d", "e"]
a → ["a", "b", "c", "d", "e"]
```

**to\_a**

*arr.to\_a* → *arr*  
*array\_subclass.to\_a* → *array*

If *arr* is an array, returns *arr*. If *arr* is a subclass of `Array`, invokes `to_ary`, and uses the result to create a new array object.

**to\_ary**

*arr.to\_ary* → *arr*

Returns *arr*.

---

**to\_s** *arr.to\_s* → *str*

---

Returns *arr.join*.

```
["a", "e", "i", "o"].to_s → "aeio"
```

---

**transpose** *arr.transpose* → *an\_array*

---

1.8 Assumes that *arr* is an array of arrays and transposes the rows and columns.

```
a = [[1,2], [3,4], [5,6]]
a.transpose → [[1, 3, 5], [2, 4, 6]]
```

---

**uniq** *arr.uniq* → *an\_array*

---

Returns a new array by removing duplicate values in *arr*, where duplicates are detected by comparing using *eql?*.

```
a = ["a", "a", "b", "b", "c"]
a.uniq → ["a", "b", "c"]
```

---

**uniq!** *arr.uniq!* → *arr* or *nil*

---

Same as *Array#uniq*, but modifies the receiver in place. Returns *nil* if no changes are made (that is, no duplicates are found).

```
a = ["a", "a", "b", "b", "c"]
a.uniq! → ["a", "b", "c"]
b = ["a", "b", "c"]
b.uniq! → nil
```

---

**unshift** *arr.unshift( <obj>+ )* → *arr*

---

Prepends object(s) to *arr*.

```
a = ["b", "c", "d"]
a.unshift("a") → ["a", "b", "c", "d"]
a.unshift(1, 2) → [1, 2, "a", "b", "c", "d"]
```

---

**values\_at** *arr.values\_at( <selector>\* )* → *an\_array*

---

1.8 Returns an array containing the elements in *arr* corresponding to the given selector(s). The selectors may be either integer indices or ranges.

```
a = %w{ a b c d e f }
a.values_at(1, 3, 5) → ["b", "d", "f"]
a.values_at(1, 3, 5, 7) → ["b", "d", "f", nil]
a.values_at(-1, -3, -5, -7) → ["f", "d", "b", nil]
a.values_at(1..3, 2...5) → ["b", "c", "d", "c", "d", "e"]
```

**Class** **Bignum** < Integer

Bignum objects hold integers outside the range of Fixnum. Bignum objects are created automatically when integer calculations would otherwise overflow a Fixnum. When a calculation involving Bignum objects returns a result that will fit in a Fixnum, the result is automatically converted.

For the purposes of the bitwise operations and [ ], a Bignum is treated as if it were an infinite-length bitstring with 2's complement representation.

While Fixnum values are immediate, Bignum objects are not—assignment and parameter passing work with references to objects, not the objects themselves.

**Instance methods****Arithmetic operations**

Performs various arithmetic operations on *big*.

<i>big</i>	+	<i>number</i>	Addition
<i>big</i>	-	<i>number</i>	Subtraction
<i>big</i>	*	<i>number</i>	Multiplication
<i>big</i>	/	<i>number</i>	Division
<i>big</i>	%	<i>number</i>	Modulo
<i>big</i>	**	<i>number</i>	Exponentiation
<i>big</i>	-@		Unary minus

**Bit operations**

Performs various operations on the binary representations of the Bignum.

<i>~ big</i>			Invert bits
<i>big</i>		<i>number</i>	Bitwise OR
<i>big</i>	&	<i>number</i>	Bitwise AND
<i>big</i>	^	<i>number</i>	Bitwise EXCLUSIVE OR
<i>big</i>	<<	<i>number</i>	Left-shift <i>number</i> bits
<i>big</i>	>>	<i>number</i>	Right-shift <i>number</i> bits (with sign extension)

**<=>** *big* <=> *number* → -1, 0, +1

Comparison—Returns -1, 0, or +1 depending on whether *big* is less than, equal to, or greater than *number*. This is the basis for the tests in Comparable.

**==** *big* == *obj* → true or false

Returns true only if *obj* has the same value as *big*. Contrast this with Bignum#eq1?, which requires *obj* to be a Bignum.

68719476736 == 68719476736.0 → true



---

**[ ]** *big[ n ]* → 0, 1

Bit Reference—Returns the *n*th bit in the (assumed) binary representation of *big*, where *big*[0] is the least significant bit.

```
a = 9**15
50.downto(0) do |n|
 print a[n]
end
```

*produces:*

```
000101110110100000111000011110010100111100010111001
```

---

**abs** *big.abs* → *bignum*

Returns the absolute value of *big*.

```
1234567890987654321.abs → 1234567890987654321
-1234567890987654321.abs → 1234567890987654321
```

---

**div** *big.div(number)* → *other\_number*

1.8 Synonym for `Bignum#/.`

```
-1234567890987654321.div(13731) → -89910996357706
-1234567890987654321.div(13731.0) → -89910996357705.5
-1234567890987654321.div(-987654321) → 1249999989
```

---

**divmod** *big.divmod(number)* → *array*

See `Numeric#divmod` on page 544.

---

**eql?** *big.eql?(obj)* → true or false

Returns true only if *obj* is a `Bignum` with the same value as *big*. Contrast this with `Bignum#==`, which performs type conversions.

```
68719476736.eql? 68719476736 → true
68719476736 == 68719476736 → true
68719476736.eql? 68719476736.0 → false
68719476736 == 68719476736.0 → true
```

---

**modulo** *big.modulo(number)* → *number*

1.8 Synonym for `Bignum#%`.

---

**quo** *big.quo(number)* → *float*

1.8 Returns the floating-point result of dividing *big* by *number*.

```
-1234567890987654321.quo(13731) → -89910996357705.5
-1234567890987654321.quo(13731.0) → -89910996357705.5
-1234567890987654321.div(-987654321) → 1249999989
```

---

**remainder** *big.remainder(number) → other\_number*

---

1.8 Returns the remainder after dividing *big* by *number*.

```
-1234567890987654321.remainder(13731) → -6966
-1234567890987654321.remainder(13731.24) → -9906.22531493148
```

---

**size** *big.size → integer*

---

Returns the number of bytes in the machine representation of *big*.

```
(256**10 - 1).size → 12
(256**20 - 1).size → 20
(256**40 - 1).size → 40
```

---

**to\_f** *big.to\_f → float*

---

Converts *big* to a Float. If *big* doesn't fit in a Float, the result is infinity.

---

**to\_s** *big.to\_s(base=10) → str*

---

1.8 Returns a string containing the representation of *big* radix *base* (2 to 36).

```
12345654321.to_s → "12345654321"
12345654321.to_s(2) → "1011011111110110111011110000110001"
12345654321.to_s(8) → "133766736061"
12345654321.to_s(16) → "2dfdbbc31"
12345654321.to_s(26) → "1dp1pc6d"
78546939656932.to_s(36) → "rubyrules"
```

**Class** **Binding** < Object

Objects of class `Binding` encapsulate the execution context at some particular place in the code and retain this context for future use. The variables, methods, value of `self`, and possibly an iterator block that can be accessed in this context are all retained. `Binding` objects can be created using `Kernel#binding` and are made available to the callback of `Kernel#set_trace_func`.

These binding objects can be passed as the second argument of the `Kernel#eval` method, establishing an environment for the evaluation.

```
class Demo
 def initialize(n)
 @secret = n
 end
 def get_binding
 return binding()
 end
end

k1 = Demo.new(99)
b1 = k1.get_binding
k2 = Demo.new(-3)
b2 = k2.get_binding

eval("@secret", b1) → 99
eval("@secret", b2) → -3
eval("@secret") → nil
```

`Binding` objects have no class-specific methods.

Class

**Class** < Module

Classes in Ruby are first-class objects—each is an instance of class `Class`.

When a new class is defined (typically using `class Name ... end`), an object of type `Class` is created and assigned to a constant (*Name*, in this case). When `Name.new` is called to create a new object, the new instance method in `Class` is run by default, which in turn invokes `allocate` to allocate memory for the object, before finally calling the new object's `initialize` method.

1.8**Class methods****inherited***cls.inherited(sub\_class)*

Invoked by Ruby when a subclass of *cls* is created. The new subclass is passed as a parameter.

```
class Top
 def Top.inherited(sub)
 puts "New subclass: #{sub}"
 end
end

class Middle < Top
end

class Bottom < Middle
end
```

*produces:*

```
New subclass: Middle
New subclass: Bottom
```

**new***Class.new(super\_class=Object) { { block } } → cls*1.8

Creates a new anonymous (unnamed) class with the given superclass (or `Object` if no parameter is given). If passed a block, that block is used as the body of the class.

```
p = lambda do
 def hello
 "Hello, Dave"
 end
end

FriendlyClass = Class.new(&p)
f = FriendlyClass.new
f.hello → "Hello, Dave"
```

## Instance methods

---

**allocate** *cls.allocate* → *obj*

---

1.8 Allocates space for a new object of *cls*'s class. The returned object must be an instance of *cls*. Calling `new` is basically the same as calling the class method `allocate` to create an object, followed by calling `initialize` on that new object. You cannot override `allocate` in normal programs; Ruby invokes it without going through conventional method dispatch.

```
class MyClass
 def MyClass.another_new(*args)
 o = allocate
 o.send(:initialize, *args)
 o
 end
 def initialize(a, b, c)
 @a, @b, @c = a, b, c
 end
end
```

```
mc = MyClass.another_new(4, 5, 6)
mc.inspect → "#<MyClass:0x1c9378 @c=6, @b=5, @a=4>"
```

---

**new** *cls.new( <args>\* )* → *obj*

---

Calls `allocate` to create a new object of *cls*'s class and then invokes the newly created object's `initialize` method, passing it *args*.

---

**superclass** *cls.superclass* → *super\_class* or *nil*

---

Returns the superclass of *cls* or returns `nil`.

```
Class.superclass → Module
Object.superclass → nil
```

**Module Comparable**

Relies on: <=>

The Comparable mixin is used by classes whose objects may be ordered. The class must define the <=> operator, which compares the receiver against another object, returning -1, 0, or +1 depending on whether the receiver is less than, equal to, or greater than the other object. Comparable uses <=> to implement the conventional comparison operators (<, <=, ==, >=, and >) and the method between?.

```
class CompareOnSize
 include Comparable
 attr :str
 def <=>(other)
 str.length <=> other.str.length
 end
 def initialize(str)
 @str = str
 end
end
```

```
s1 = CompareOnSize.new("Z")
s2 = CompareOnSize.new([1,2])
s3 = CompareOnSize.new("XXX")
```

```
s1 < s2 → true
s2.between?(s1, s3) → true
s3.between?(s1, s2) → false
[s3, s2, s1].sort → ["Z", [1, 2], "XXX"]
```

**Instance methods****Comparisons**

*obj* < *other\_object* → true or false  
*obj* <= *other\_object* → true or false  
*obj* == *other\_object* → true or false  
*obj* >= *other\_object* → true or false  
*obj* > *other\_object* → true or false

Compares two objects based on the receiver's <=> method.

**between?**

*obj*.between?(*min*, *max*) → true or false

Returns false if *obj* <=> *min* is less than zero or if *obj* <=> *max* is greater than zero, true otherwise.

```
3.between?(1, 5) → true
6.between?(1, 5) → false
'cat'.between?('ant', 'dog') → true
'gnu'.between?('ant', 'dog') → false
```

**Continuation** < Object

Continuation objects are generated by `Kernel#callcc`. They hold a return address and execution context, allowing a nonlocal return to the end of the `callcc` block from anywhere within a program. Continuations are somewhat analogous to a structured version of C's `setjmp/longjmp` (although they contain more state, so you may consider them closer to threads).

This (somewhat contrived) example allows the inner loop to abandon processing early.

```
callcc do |cont|
 for i in 0..4
 print "\n#{i}: "
 for j in i*5...(i+1)*5
 cont.call() if j == 7
 printf "%3d", j
 end
 end
end
print "\n"
```

*produces:*

```
0: 0 1 2 3 4
1: 5 6
```

This example shows that the call stack for methods is preserved in continuations.

```
def strange
 callcc {|continuation| return continuation}
 print "Back in method, "
end
print "Before method. "
continuation = strange()
print "After method. "
continuation.call if continuation
```

*produces:*

```
Before method. After method. Back in method, After method.
```

**Instance methods****call**

*cont.call( < args >\*)*

Invokes the continuation. The program continues from the end of the `callcc` block. If no arguments are given, the original `callcc` returns `nil`. If one argument is given, `callcc` returns it. Otherwise, an array containing *args* is returned.

```
callcc {|cont| cont.call } → nil
callcc {|cont| cont.call 1 } → 1
callcc {|cont| cont.call 1, 2, 3 } → [1, 2, 3]
```

**Class** **Dir** < Object

Objects of class `Dir` are directory streams representing directories in the underlying filesystem. They provide a variety of ways to list directories and their contents. See also `File`, page 444.

The directory used in these examples contains the two regular files (`config.h` and `main.rb`), the parent directory (`..`), and the directory itself (`.`).

**Mixes in****Enumerable:**

`all?`, `any?`, `collect`, `detect`, `each_with_index`, `entries`, `find`, `find_all`, `grep`, `include?`, `inject`, `map`, `max`, `member?`, `min`, `partition`, `reject`, `select`, `sort`, `sort_by`, `to_a`, `zip`

**Class methods**

**[ ]** `Dir[ glob_pattern ] → array`

1.8 Equivalent to calling `Dir.glob(glob_pattern, 0)`.

**chdir** `Dir.chdir( < dir > ) → 0`  
`Dir.chdir( < dir > ) { |path| block } → obj`

Changes the current working directory of the process to the given string. When called without an argument, changes the directory to the value of the environment variable `HOME` or `LOGDIR`. Raises a `SystemCallError` (probably `Errno::ENOENT`) if the target directory does not exist.

1.8 If a block is given, it is passed the name of the new current directory, and the block is executed with that as the current directory. The original working directory is restored when the block exits. The return value of `chdir` is the value of the block. `chdir` blocks can be nested, but in a multithreaded program an error will be raised if a thread attempts to open a `chdir` block while another thread has one open. This is because the underlying operating system only understands the concept of a single current working directory at any one time.

```
Dir.chdir("/var/log")
puts Dir.pwd
Dir.chdir("/tmp") do
 puts Dir.pwd
 Dir.chdir("/usr") do
 puts Dir.pwd
 end
 puts Dir.pwd
end
puts Dir.pwd
```



*produces:*

```
/var/log
/tmp
/usr
/tmp
/var/log
```

---

**chroot** Dir.chroot(*dirname*) → 0

---

Changes this process's idea of the file system root. Only a privileged process may make this call. Not available on all platforms. On Unix systems, see `chroot(2)` for more information.

```
Dir.chdir("/production/secure/root")
Dir.chroot("/production/secure/root") → 0
Dir.pwd → "/"
```

---

**delete** Dir.delete(*dirname*) → 0

---

Deletes the named directory. Raises a subclass of `SystemCallError` if the directory isn't empty.

---

**entries** Dir.entries(*dirname*) → array

---

Returns an array containing all of the filenames in the given directory. Will raise a `SystemCallError` if the named directory doesn't exist.

```
Dir.entries("testdir") → [".", "..", "config.h", "main.rb"]
```

---

**foreach** Dir.foreach(*dirname*) {|filename| block } → nil

---

Calls the block once for each entry in the named directory, passing the filename of each entry as a parameter to the block.

```
Dir.foreach("testdir") {|x| puts "Got #{x}" }
```

*produces:*

```
Got .
Got ..
Got config.h
Got main.rb
```

---

**getwd** Dir.getwd → *dirname*

---

Returns a string containing the canonical path to the current working directory of this process. Note that on some operating systems this name may not be the name you gave to `Dir.chdir`. On OS X, for example, `/tmp` is a symlink.

```
Dir.chdir("/tmp") → 0
Dir.getwd → "/private/tmp"
```

**glob**Dir.glob( *glob\_pattern*, ⟨ *flags* ⟩ ) → *array*Dir.glob( *glob\_pattern*, ⟨ *flags* ⟩ ) { |*filename*| *block* } → *false*1.8

Returns the filenames found by expanding the pattern given in *glob\_pattern*, either as elements in *array* or as parameters to the block. Note that this pattern is not a regexp (it's closer to a shell glob). See `File.fnmatch` on page 447 for the meaning of the *flags* parameter. Case sensitivity depends on your system (so `File::FNM_CASEFOLD` is ignored). Metacharacters in the pattern are

- \* Any sequence of characters in a filename: "\*" will match all files, "c\*" will match all files beginning with "c", "\*c" will match all files ending with "c", and "\*c\*" will match all files that have "c" in their name.
- \*\* Matches zero or more directories (so "\*\*\*/fred") matches a file named "fred" in or below the current directory).
- ? Matches any one character in a filename.
- [ *chars* ] Matches any one of *chars*. If the first character in *chars* is ^, matches any character not in the remaining set.
- { *patt*, ... } Matches one of the patterns specified between braces. These patterns may contain other metacharacters.
- \ Removes any special significance in the next character.

```
Dir.chdir("testdir") → 0
Dir["config.?"] → ["config.h"]
Dir.glob("config.?") → ["config.h"]
Dir.glob("*. [a-z][a-z]") → ["main.rb"]
Dir.glob("*. [^r]*") → ["config.h"]
Dir.glob("*. {rb,h}") → ["main.rb", "config.h"]
Dir.glob("*") → ["config.h", "main.rb"]
Dir.glob("*", File::FNM_DOTMATCH) → [".", "..", "config.h", "main.rb"]

Dir.chdir("..") → 0
Dir.glob("code/**/fib*.rb") → ["code/fib_up_to.rb", "code/rdoc/fib_example.rb"]
Dir.glob("**/rdoc/fib*.rb") → ["code/rdoc/fib_example.rb"]
```

**mkdir**Dir.mkdir( *dirname* ⟨ *permissions* ⟩ ) → 0

Makes a new directory named *dirname*, with permissions specified by the optional parameter *permissions*. The permissions may be modified by the value of `File.umask` and are ignored on Windows. Raises a `SystemCallError` if the directory cannot be created. See also the discussion of permissions on page 444.

**new**Dir.new( *dirname* ) → *dir*

Returns a new directory object for the named directory.

---

**open** Dir.open( *dirname* ) → *dir*  
Dir.open( *dirname* ) { |*dir*| *block* } → *obj*

---

1.8

With no block, open is a synonym for Dir.new. If a block is present, it is passed *dir* as a parameter. The directory is closed at the end of the block, and Dir.open returns the value of the block.

---

**pwd** Dir.pwd → *dirname*

---

Synonym for Dir.getwd.

---

**rmdir** Dir.rmdir( *dirname* ) → 0

---

Synonym for Dir.delete.

---

**unlink** Dir.unlink( *dirname* ) → 0

---

Synonym for Dir.delete.

## Instance methods

---

**close** *dir*.close → nil

---

Closes the directory stream. Any further attempts to access *dir* will raise an IOError.

```
d = Dir.new("testdir")
d.close → nil
```

---

**each** *dir*.each { |*filename*| *block* } → *dir*

---

Calls the block once for each entry in this directory, passing the filename of each entry as a parameter to the block.

```
d = Dir.new("testdir")
d.each { |name| puts "Got #{name}" }
```

*produces:*

```
Got .
Got ..
Got config.h
Got main.rb
```

---

**path** *dir*.path → *dirname*

---

1.8

Returns the path parameter passed to *dir*'s constructor.

```
d = Dir.new("../")
d.path → "../"
```

---

**pos** *dir*.pos → *int*

---

1.8

Synonym for Dir#tell.

---

**pos=** *dir.pos( int ) → int*

---

1.8 Synonym for Dir#seek, but returns the position parameter.

```
d = Dir.new("testdir") → #<Dir:0x1c9378>
d.read → "."
i = d.pos → 1
d.read → ".."
d.pos = i → 1
d.read → ".."
```

---

**read** *dir.read → filename or nil*

---

Reads the next entry from *dir* and returns it as a string. Returns nil at the end of the stream.

```
d = Dir.new("testdir")
d.read → "."
d.read → ".."
d.read → "config.h"
```

---

**rewind** *dir.rewind → dir*

---

Repositions *dir* to the first entry.

```
d = Dir.new("testdir")
d.read → "."
d.rewind → #<Dir:0x1c96e8>
d.read → "."
```

---

**seek** *dir.seek( int ) → dir*

---

Seeks to a particular location in *dir*. *int* must be a value returned by Dir#tell (it is not necessarily a simple index into the entries).

```
d = Dir.new("testdir") → #<Dir:0x1c9378>
d.read → "."
i = d.tell → 1
d.read → ".."
d.seek(i) → #<Dir:0x1c9378>
d.read → ".."
```

---

**tell** *dir.tell → int*

---

Returns the current position in *dir*. See also Dir#seek.

```
d = Dir.new("testdir")
d.tell → 1
d.read → "."
d.tell → 2
```

**Module**

# Enumerable

Relies on: each, <=>

The Enumerable mixin provides collection classes with several traversal and searching methods and with the ability to sort. The class must provide a method each, which yields successive members of the collection. If Enumerable#max, #min, #sort, or #sort\_by is used, the objects in the collection must also implement a meaningful <=> operator, as these methods rely on an ordering between members of the collection.

## Instance methods

---

**all?** *enum.all?* <{|obj| block }> → true or false

---

1.8 Passes each element of the collection to the given block. The method returns true if the block never returns false or nil. If the block is not given, Ruby adds an implicit block of {|obj| obj} (that is all? will return true only if none of the collection members is false or nil.)

```
%w{ ant bear cat }.all? {|word| word.length >= 3} → true
%w{ ant bear cat }.all? {|word| word.length >= 4} → false
[nil, true, 99].all? → false
```

---

**any?** *enum.any?* <{|obj| block }> → true or false

---

1.8 Passes each element of the collection to the given block. The method returns true if the block ever returns a value other than false or nil. If the block is not given, Ruby adds an implicit block of {|obj| obj} (that is, any? will return true if at least one of the collection members is not false or nil).

```
%w{ ant bear cat }.any? {|word| word.length >= 3} → true
%w{ ant bear cat }.any? {|word| word.length >= 4} → true
[nil, true, 99].any? → true
```

---

**collect** *enum.collect* {|obj| block } → array

---

Returns a new array containing the results of running *block* once for every element in *enum*.

```
(1..4).collect {|i| i*i } → [1, 4, 9, 16]
(1..4).collect { "cat" } → ["cat", "cat", "cat", "cat"]
```

---

**detect** *enum.detect*( ifnone = nil ) {|obj| block } → obj or nil

---

1.8 Passes each entry in *enum* to *block*. Returns the first for which *block* is not false. Returns nil if no object matches unless the proc *ifnone* is given, in which case it is called and its result returned.

```
(1..10).detect {|i| i % 5 == 0 and i % 7 == 0 } → nil
(1..100).detect {|i| i % 5 == 0 and i % 7 == 0 } → 35
sorry = lambda { "not found" }
(1..10).detect(sorry) {|i| i > 50} → "not found"
```

---

**each\_with\_index** *enum.each\_with\_index* { |obj, i| block } → *enum*

---

Calls *block* with two arguments, the item and its index, for each item in *enum*.

```
hash = Hash.new
%w(cat dog wombat).each_with_index do |item, index|
 hash[item] = index
end
hash → {"cat"=>0, "wombat"=>2, "dog"=>1}
```

---

**entries** *enum.entries* → *array*

---

Synonym for `Enumerable#to_a`.

---

**find** *enum.find*( ifnone = nil ) { |obj| block } → *obj* or *nil*

---

Synonym for `Enumerable#detect`.

---

**find\_all** *enum.find\_all* { |obj| block } → *array*

---

Returns an array containing all elements of *enum* for which *block* is not false (see also `Enumerable#reject`).

```
(1..10).find_all {|i| i % 3 == 0 } → [3, 6, 9]
```

---

**grep** *enum.grep*( pattern ) → *array*  
*enum.grep*( pattern ) { |obj| block } → *array*

---

Returns an array of every element in *enum* for which `pattern === element`. If the optional *block* is supplied, each matching element is passed to it, and the block's result is stored in the output array.

```
(1..100).grep 38..44 → [38, 39, 40, 41, 42, 43, 44]
c = IO.constants
c.grep(/SEEK/) → ["SEEK_CUR", "SEEK_SET", "SEEK_END"]
res = c.grep(/SEEK/) {|v| IO.const_get(v) }
res → [1, 0, 2]
```

---

**include?** *enum.include?*( obj ) → true or false

---

Returns true if any member of *enum* equals *obj*. Equality is tested using `==`.

```
IO.constants.include? "SEEK_SET" → true
IO.constants.include? "SEEK_NO_FURTHER" → false
```

---

**inject** *enum.inject(initial) {|memo, obj| block } → obj*  
*enum.inject {|memo, obj| block } → obj*

---

1.8 Combines the elements of *enum* by applying the block to an accumulator value (*memo*) and each element in turn. At each step, *memo* is set to the value returned by the block. The first form lets you supply an initial value for *memo*. The second form uses the first element of the collection as the initial value (and skips that element while iterating).

```
Sum some numbers
(5..10).inject { |sum, n| sum + n } → 45
Multiply some numbers
(5..10).inject(1) {|product, n| product * n } → 151200

find the longest word
longest = %w{ cat sheep bear }.inject do |memo, word|
 memo.length > word.length ? memo : word
end
longest → "sheep"

find the length of the longest word
longest = %w{ cat sheep bear }.inject(0) do |memo, word|
 memo >= word.length ? memo : word.length
end
longest → 5
```

---

**map** *enum.map {|obj| block } → array*

---

Synonym for `Enumerable#collect`.

---

**max** *enum.max → obj*  
*enum.max {|a,b| block } → obj*

---

Returns the object in *enum* with the maximum value. The first form assumes all objects implement `<=>`; the second uses the block to return  $a <=> b$ .

```
a = %w(albatross dog horse)
a.max → "horse"
a.max {|a,b| a.length <=> b.length } → "albatross"
```

---

**member?** *enum.member?(obj) → true or false*

---

Synonym for `Enumerable#include?`.

---

**min** *enum.min → obj*  
*enum.min {|a,b| block } → obj*

---

Returns the object in *enum* with the minimum value. The first form assumes all objects implement `Comparable`; the second uses the block to return  $a <=> b$ .

```
a = %w(albatross dog horse)
a.min → "albatross"
a.min {|a,b| a.length <=> b.length } → "dog"
```

---

**partition** *enum.partition* { |obj| block } → [ true\_array, false\_array ]

---

1.8 Returns two arrays, the first containing the elements of *enum* for which the block evaluates to true, the second containing the rest.

```
(1..6).partition {|i| (i&1).zero?} → [[2, 4, 6], [1, 3, 5]]
```

---

**reject** *enum.reject* { |obj| block } → array

---

Returns an array containing the elements of *enum* for which *block* is false (see also `Enumerable#find_all`).

```
(1..10).reject {|i| i % 3 == 0} → [1, 2, 4, 5, 7, 8, 10]
```

---

**select** *enum.select* { |obj| block } → array

---

Synonym for `Enumerable#find_all`.

---

**sort** *enum.sort* → array  
*enum.sort* { |a, b| block } → array

---

Returns an array containing the items in *enum* sorted, either according to their own `<=>` method or by using the results of the supplied block. The block should return `-1`, `0`, or `+1` depending on the comparison between *a* and *b*. As of Ruby 1.8, the method `Enumerable#sort_by` implements a built-in Schwartzian Transform, useful when key computation or comparison is expensive.

```
%w(rhea kea flea).sort → ["flea", "kea", "rhea"]
```

```
(1..10).sort {|a,b| b <=> a} → [10, 9, 8, 7, 6, 5, 4, 3, 2, 1]
```

---

**sort\_by** *enum.sort\_by* { |obj| block } → array

---

1.8 Sorts *enum* using keys generated by mapping the values in *enum* through the given block, using the result of that block for element comparison.

```
sorted = %w{ apple pear fig }.sort_by {|word| word.length}
```

```
sorted → ["fig", "pear", "apple"]
```

Internally, `sort_by` generates an array of tuples containing the original collection element and the mapped value. This makes `sort_by` fairly expensive when the keysets are simple.

```
require 'benchmark'
include Benchmark
a = (1..100000).map {rand(100000)}
bm(10) do |b|
 b.report("Sort") { a.sort }
 b.report("Sort by") { a.sort_by {|a| a} }
end
```



*produces:*

```

 user system total real
Sort 0.070000 0.010000 0.080000 (0.085860)
Sort by 1.580000 0.010000 1.590000 (1.811626)

```

However, consider the case where comparing the keys is a nontrivial operation. The following code sorts some files on modification time using the basic `sort` method.

```

files = Dir["*"]

sorted = files.sort {|a,b| File.new(a).mtime <=> File.new(b).mtime}

sorted → ["mon", "tues", "wed", "thurs"]

```

This sort is inefficient: it generates two new `File` objects during every comparison. A slightly better technique is to use the `Kernel#test` method to generate the modification times directly.

```

files = Dir["*"]

sorted = files.sort do |a,b|
 test(?M, a) <=> test(?M, b)
end

sorted → ["mon", "tues", "wed", "thurs"]

```

This still generates many unnecessary `Time` objects. A more efficient technique is to cache the sort keys (modification times in this case) before the sort. Perl users often call this approach a Schwartzian Transform, named after Randal Schwartz. We construct a temporary array, where each element is an array containing our sort key along with the filename. We sort this array and then extract the filename from the result.

```

sorted = Dir["*"].collect {|f|
 [test(?M, f), f]
}.sort.collect {|f| f[1] }

sorted → ["mon", "tues", "wed", "thurs"]

```

This is exactly what `sort_by` does internally.

```

sorted = Dir["*"].sort_by {|f| test(?M, f)}

sorted → ["mon", "tues", "wed", "thurs"]

```

`sort_by` can also be useful for multilevel sorts. One trick, which relies on the fact that arrays are compared element by element, is to have the block return an array of each of the comparison keys. For example, to sort a list of words first on their length and then alphabetically, you could write.

```

words = %w{ puma cat bass ant aardvark gnu fish }
sorted = words.sort_by {|w| [w.length, w] }
sorted → ["ant", "cat", "gnu", "bass", "fish", "puma", "aardvark"]

```

---

**to\_a** *enum.to\_a* → *array*

---

Returns an array containing the items in *enum*.

```
(1..7).to_a → [1, 2, 3, 4, 5, 6, 7]
{ 'a'=>1, 'b'=>2, 'c'=>3 }.to_a → [{"a", 1}, {"b", 2}, {"c", 3}]
```

---

**zip** *enum.zip*( < *arg* >+ ) → *array*  
*enum.zip*( < *arg* >+ ) { |*arr*| *block* } → *nil*

---

1.8

Converts any arguments to arrays and then merges elements of *enum* with corresponding elements from each argument. The result is an array containing the same number of elements as *enum*. Each element is a *n*-element array, where *n* is one more than the count of arguments. If the size of any argument is less than the number of elements in *enum*, *nil* values are supplied. If a block given, it is invoked for each output array, otherwise an array of arrays is returned.

```
a = [4, 5, 6]
b = [7, 8, 9]

(1..3).zip(a, b) → [[1, 4, 7], [2, 5, 8], [3, 6, 9]]
"cat\ndog".zip([1]) → [{"cat\n", 1}, {"dog", nil}]
(1..3).zip → [[1], [2], [3]]
```

## Module Errno

Ruby exception objects are subclasses of `Exception`. However, operating systems typically report errors using plain integers. Module `Errno` is created dynamically to map these operating system errors to Ruby classes, with each error number generating its own subclass of `SystemCallError`. As the subclass is created in module `Errno`, its name will start `Errno::`.

```
Exception
 StandardError
 SystemCallError
 Errno::xxx
```

The names of the `Errno::` classes depend on the environment in which Ruby runs. On a typical Unix or Windows platform, you'll find Ruby has `Errno` classes such as `Errno::EACCES`, `Errno::EAGAIN`, `Errno::EINTR`, and so on.

The integer operating system error number corresponding to a particular error is available as the class constant `Errno::error::Errno`.

```
Errno::EACCES::Errno → 13
Errno::EAGAIN::Errno → 35
Errno::EINTR::Errno → 4
```

The full list of operating system errors on your particular platform is available as the constants of `Errno`. Any user-defined exceptions in this module (including subclasses of existing exceptions) must also define an `Errno` constant.

```
Errno.constants → E2BIG, EACCES, EADDRINUSE, EADDRNOTAVAIL,
 EAFNOSUPPORT, EAGAIN, EALREADY, ...
```

### 1.8

As of Ruby 1.8, exceptions are matched in `rescue` clauses using `Module#===`. The `===` method is overridden for class `SystemCallError` to compare based on the `Errno` value. Thus if two distinct `Errno` classes have the same underlying `Errno` value, they will be treated as the same exception by a `rescue` clause.

**Class** **Exception** < Object

Descendents of class `Exception` are used to communicate between `raise` methods and `rescue` statements in `begin/end` blocks. `Exception` objects carry information about the exception—its type (the exception’s class name), an optional descriptive string, and optional traceback information.

The standard library defines the exceptions shown in Figure 27.1 on the following page. See also the description of `Errno` on the page before.

**Class methods**

---

**exception** `Exception.exception( < message > ) → exc`

---

Creates and returns a new exception object, optionally setting the message to *message*.

---

**new** `Exception.new( < message > ) → exc`

---

Creates and returns a new exception object, optionally setting the message to *message*.

**Instance methods**

---

**backtrace** `exc.backtrace → array`

---

Returns any backtrace associated with the exception. The backtrace is an array of strings, each containing either *filename:line: in 'method'* or *filename:line*.

```
def a
 raise "boom"
end
def b
 a()
end
begin
 b()
rescue => detail
 print detail.backtrace.join("\n")
end
```

*produces:*

```
prog.rb:2:in `a'
prog.rb:6:in `b'
prog.rb:10
```

---

**exception** `exc.exception( < message > ) → exc or exception`

---

With no argument, returns the receiver. Otherwise, creates a new exception object of the same class as the receiver but with a different message.

Figure 27.1. Standard exception hierarchy

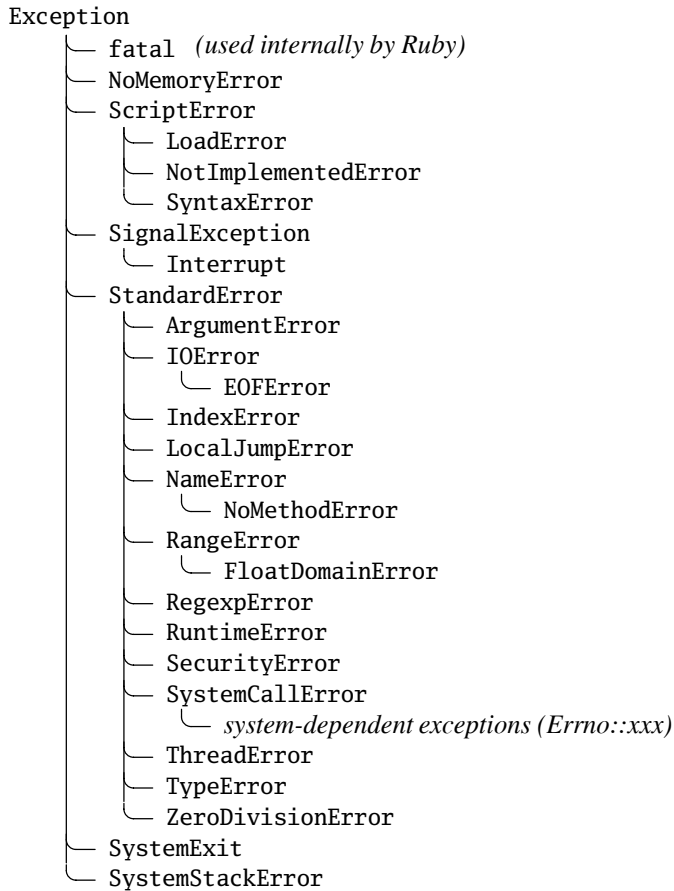

---

**message** *exc.message* → *msg*

Returns the message associated with this exception.

---

**set\_backtrace** *exc.set\_backtrace( array )* → *array*

Sets the backtrace information associated with *exc*. The argument must be an array of String objects in the format described in `Exception#backtrace`.

---

**status** *exc.status* → *status*

1.8 (SystemExit only) Returns the exit status associated with this SystemExit exception. Normally this status is set using the `Kernel#exit`.

```
begin
 exit(99)
rescue SystemExit => e
 puts "Exit status is: #{e.status}"
end

produces:
Exit status is: 99
```

---

**success?** *exc.success?* → true or false

---

1.8 (SystemExit only) Returns true if the exit status is nil or zero.

```
begin
 exit(99)
rescue SystemExit => e
 print "This program "
 if e.success?
 print "did"
 else
 print "did not"
 end
 puts " succeed"
end
```

*produces:*  
This program did not succeed

---

**to\_s** *exc.to\_s* → msg

---

Returns the message associated with this exception (or the name of the exception if no message is set).

```
begin
 raise "The message"
rescue Exception => e
 puts e.to_s
end
```

*produces:*  
The message

---

**to\_str** *exc.to\_str* → msg

---

Returns the message associated with this exception (or the name of the exception if no message is set). Implementing `to_str` gives exceptions a stringlike behavior.

**Class FalseClass** < Object

The global value `false` is the only instance of class `FalseClass` and represents a logically false value in boolean expressions. The class provides operators allowing `false` to participate correctly in logical expressions.

**Instance methods**

---

**&** `false & obj → false`

---

And—Returns `false`. *obj* is always evaluated as it is the argument to a method call—no short-circuit evaluation is performed in this case. In other words, the following code, which uses `&&`, will not invoke the `lookup` method.

```
def lookup(val)
 puts "Looking up #{val}"
 return true
end
false && lookup("cat")
```

However, this code, using `&`, will:

```
false & lookup("cat")
```

*produces:*

```
Looking up cat
```

---

**^** `false ^ obj → true or false`

---

Exclusive Or—If *obj* is `nil` or `false`, returns `false`; otherwise, returns `true`.

---

**|** `false | obj → true or false`

---

Or—Returns `false` if *obj* is `nil` or `false`; `true` otherwise.

## Class

**File** < IO

A `File` is an abstraction of any file object accessible by the program and is closely associated with class `IO`, page 482. `File` includes the methods of module `FileTest` as class methods, allowing you to write (for example) `File.exist?("foo")`.

In this section, *permission bits* are a platform-specific set of bits that indicate permissions of a file. On Unix-based systems, permissions are viewed as a set of three octets, for the owner, the group, and the rest of the world. For each of these entities, permissions may be set to read, write, or execute the file.

Owner			Group			Other		
r	w	x	r	w	x	r	w	x
4	2	1	4	2	1	4	2	1

The permission bits 0644 (in octal) would thus be interpreted as read/write for owner and read-only for group and other. Higher-order bits may also be used to indicate the type of file (plain, directory, pipe, socket, and so on) and various other special features. If the permissions are for a directory, the meaning of the execute bit changes; when set, the directory can be searched.

Each file has three associated times. The *atime* is the time the file was last accessed. The *ctime* is the time that the file status (not necessarily the file contents) were last changed. Finally, the *mtime* is the time the file's data was last modified. In Ruby, all these times are returned as `Time` objects.

On non-POSIX operating systems, there may be only the ability to make a file read-only or read/write. In this case, the remaining permission bits will be synthesized to resemble typical values. For instance, on Windows the default permission bits are 0644, which means read/write for owner, read-only for all others. The only change that can be made is to make the file read-only, which is reported as 0444.

See also `Pathname` on page 693.

**Class methods****atime**

---

`File.atime(filename) → time`

Returns a `Time` object containing the last access time for the named file, or returns epoch if the file has not been accessed.

```
File.atime("testfile") → Thu Aug 26 22:36:07 CDT 2004
```

**basename**

---

`File.basename(filename [, suffix]) → string`

Returns the last component of the filename given in *filename*. If *suffix* is given and present at the end of *filename*, it is removed. Any extension can be removed by giving an extension of `".*"`.

1.8





```
File.basename("/home/gumby/work/ruby.rb") → "ruby.rb"
File.basename("/home/gumby/work/ruby.rb", ".rb") → "ruby"
File.basename("/home/gumby/work/ruby.rb", ".*") → "ruby"
```

---

**blockdev?** File.blockdev?(*filename*) → true or false

---

Returns true if the named file is a block device, and returns false if it isn't or if the operating system doesn't support this feature.

```
File.blockdev?("testfile") → false
```

---

**chardev?** File.chardev?(*filename*) → true or false

---

Returns true if the named file is a character device, and returns false if it isn't or if the operating system doesn't support this feature.

```
File.chardev?("/dev/tty") → true
```

---

**chmod** File.chmod(*permission* < , *filename* )<sup>+</sup> → int

---

Changes permission bits on the named file(s) to the bit pattern represented by *permission*. Actual effects are operating system dependent (see the beginning of this section). On Unix systems, see `chmod(2)` for details. Returns the number of files processed.

```
File.chmod(0644, "testfile", "out") → 2
```

---

**chown** File.chown(*owner*, *group* < , *filename* )<sup>+</sup> → int

---

Changes the owner and/or group of the named file(s) to the given numeric owner and group IDs. Only a process with superuser privileges may change the owner of a file. The current owner of a file may change the file's group to any group to which the owner belongs. A nil or -1 owner or group ID is ignored. Returns the number of files processed.

```
File.chown(nil, 100, "testfile")
```

---

**ctime** File.ctime(*filename*) → time

---

Returns a Time object containing the time that the file status associated with the named file was changed.

```
File.ctime("testfile") → Thu Aug 26 22:37:31 CDT 2004
```

---

**delete** File.delete( < *filename* )<sup>+</sup> → int

---

Deletes the named file(s). Returns the number of files processed. See also `Dir.rmdir`.

```
File.open("testrm", "w+") {}
File.delete("testrm") → 1
```

---

**directory?** File.directory?(*path*) → true or false

---

Returns true if the named file is a directory, false otherwise.

```
File.directory?(".") → true
```

---

**dirname** File.dirname(*filename*) → *filename*

---

Returns all components of the filename given in *filename* except the last one.

```
File.dirname("/home/gumby/work/ruby.rb") → "/home/gumby/work"
File.dirname("ruby.rb") → "."
```

---

**executable?** File.executable?(*filename*) → true or false

---

Returns true if the named file is executable. The tests are made using the effective owner of the process.

```
File.executable?("testfile") → false
```

---

**executable\_real?** File.executable\_real?(*filename*) → true or false

---

Same as File#executable?, but tests using the real owner of the process.

---

**exist?** File.exist?(*filename*) → true or false

---

Returns true if the named file or directory exists.

```
File.exist?("testfile") → true
```

---

**exists?** File.exists?(*filename*) → true or false

---

Synonym for File.exist?.

---

**expand\_path** File.expand\_path(*filename* [, *dirstring*]) → *filename*

---

Converts a pathname to an absolute pathname. Relative paths are referenced from the current working directory of the process unless *dirstring* is given, in which case it will be used as the starting point. The given pathname may start with a ~, which expands to the process owner's home directory (the environment variable HOME must be set correctly). ~*user* expands to the named user's home directory.

```
File.expand_path("~/testuser/bin") → "/Users/testuser/bin"
File.expand_path(".././bin", "/tmp/x") → "/bin"
```

---

**extname** File.extname(*path*) → *string*

---

1.8 Returns the extension (the portion of filename in *path* after the period).

```
File.extname("test.rb") → ".rb"
File.extname("a/b/d/test.rb") → ".rb"
File.extname("test") → ""
```

Table 27.2. Match-mode constants

FNM_NOESCAPE	Backslash does not escape special characters in globs, and a backslash in the pattern must match a backslash in the filename.
FNM_PATHNAME	Forward slashes in the filename are treated as separating parts of a path and so must be explicitly matched in the pattern.
FNM_DOTMATCH	If this option is not specified, filenames containing leading periods must be matched by an explicit period in the pattern. A leading period is one at the start of the filename or (if FNM_PATHNAME is specified) following a slash.
FNM_CASEFOLD	Filename matches are case insensitive

---

**file?** File.file?( *filename* ) → true or false

---

Returns true if the named file is a regular file (not a device file, directory, pipe, socket, and so on).

```
File.file?("testfile") → true
File.file?(".") → false
```

---

**fnmatch** File.fnmatch( *glob\_pattern*, *path*, { *flags* } ) → true or false

---

1.8

Returns true if *path* matches against *glob\_pattern*. The pattern is not a regular expression; instead it follows rules similar to shell filename globbing. Because `fnmatch` is implemented by the underlying operating system, it may have different semantics to `Dir.glob`. A *glob\_pattern* may contain the following metacharacters.

---

**	Matches subdirectories recursively.
*	Matches zero or more characters.
?	Matches any single character.
[ <i>charset</i> ]	Matches any character from the given set of characters. A range of characters is written as <i>from-to</i> . The set may be negated with an initial caret (^).
\	Escapes any special meaning of the next character.

---

*flags* is a bitwise OR of the FNM\_xxx parameters listed on the current page. See also `Dir.glob` on page 430.

```
File.fnmatch('cat', 'cat') → true
File.fnmatch('cat', 'category') → false
File.fnmatch('c{at,ub}s', 'cats') → false
File.fnmatch('c{at,ub}s', 'cubs') → false
File.fnmatch('c{at,ub}s', 'cat') → false
File.fnmatch('c?t', 'cat') → true
File.fnmatch('c\?t', 'cat') → false
```

```

File.fnmatch('c??t', 'cat') → false
File.fnmatch('c*', 'cats') → true
File.fnmatch('c**/t', 'c/a/b/c/t') → true
File.fnmatch('c*t', 'cat') → true
File.fnmatch('c\at', 'cat') → true
File.fnmatch('c\at', 'cat', File::FNM_NOESCAPE) → false
File.fnmatch('a?b', 'a/b') → true
File.fnmatch('a?b', 'a/b', File::FNM_PATHNAME) → false

File.fnmatch('*', '.profile') → false
File.fnmatch('*', '.profile', File::FNM_DOTMATCH) → true
File.fnmatch('*', 'dave/.profile') → true
File.fnmatch('*', 'dave/.profile', File::FNM_DOTMATCH) → true
File.fnmatch('*', 'dave/.profile', File::FNM_PATHNAME) → false
File.fnmatch('*/*', 'dave/.profile', File::FNM_PATHNAME) → false
STRICT = File::FNM_PATHNAME | File::FNM_DOTMATCH
File.fnmatch('*/*', 'dave/.profile', STRICT) → true

```

---

**fnmatch?** `File.fnmatch?(glob_pattern, path, <flags>)` → (true or false)

---

1.8    Synonym for `File#fnmatch`.

---

**ftype** `File.ftype(filename)` → *filetype*

---

Identifies the type of the named file. The return string is one of `file`, `directory`, `characterSpecial`, `blockSpecial`, `fifo`, `link`, `socket`, or `unknown`.

```

File.ftype("testfile") → "file"
File.ftype("/dev/tty") → "characterSpecial"
system("mkfifo wibble") → true
File.ftype("wibble") → "fifo"

```

---

**grpowned?** `File.grpowned?(filename)` → true or false

---

Returns true if the effective group ID of the process is the same as the group ID of the named file. On Windows, returns false.

```
File.grpowned?("/etc/passwd") → false
```

---

**join** `File.join(<string>+)` → *filename*

---

Returns a new string formed by joining the strings using `File::SEPARATOR`. The various separators are listed in Table 27.3 on the next page.

```
File.join("usr", "mail", "gumby") → "usr/mail/gumby"
```

---

**lchmod** `File.lchmod(permission, <filename>+)` → 0

---

1.8    Equivalent to `File.chmod`, but does not follow symbolic links (so it will change the permissions associated with the link, not the file referenced by the link). Often not available.

Table 27.3. Path separator constants (platform specific)

ALT_SEPARATOR	Alternate path separator.
PATH_SEPARATOR	Separator for filenames in a search path (such as : or ;).
SEPARATOR	Separator for directory components in a filename (such as \ or /).
Separator	Alias for SEPARATOR.

---

**lchown** File.lchown(*owner*, *group*,  $\langle filename \rangle^+$ ) → 0

---

1.8 Equivalent to File.chown, but does not follow symbolic links (so it will change the owner associated with the link, not the file referenced by the link). Often not available.

---

**link** File.link(*oldname*, *newname*) → 0

---

Creates a new name for an existing file using a hard link. Will not overwrite *newname* if it already exists (in which case link raises a subclass of SystemCallError). Not available on all platforms.

```
File.link("testfile", "testfile.lnk") → 0
f = File.open("testfile.lnk")
f.gets → "This is line one\n"
File.delete("testfile.lnk")
```

---

**lstat** File.lstat(*filename*) → stat

---

Returns status information for *file* as an object of type File::Stat. Same as IO#stat (see page 492), but does not follow the last symbolic link. Instead, reports on the link itself.

```
File.symlink("testfile", "link2test") → 0
File.stat("testfile").size → 66
File.lstat("link2test").size → 8
File.stat("link2test").size → 66
```

---

**mtime** File.mtime(*filename*) → time

---

Returns a Time object containing the modification time for the named file.

```
File.mtime("testfile") → Thu Aug 26 12:33:23 CDT 2004
File.mtime("/tmp") → Thu Aug 26 22:36:41 CDT 2004
```

---

**new** File.new(*filename*, *modestring*="r") → file  
File.new(*filename*  $\langle$ , *modenum*  $\langle$ , *permission*  $\rangle$ ) → file  
File.new(*fd*  $\langle$ , *modenum*  $\langle$ , *permission*  $\rangle$ ) → file

---

Opens the file named by *filename* (or associates the already-open file given by *fd*) according to *modestring* (the default is r) and returns a new File object. The *modestring* is described in Table 27.6 on page 483. The file mode may optionally be specified as a Fixnum by *or*-ing together the flags described in Table 27.4 on page 451. Optional

permission bits may be given in *permission*. These mode and permission bits are platform dependent; on Unix systems, see `open(2)` for details.

```
f = File.new("testfile", "r")
f = File.new("newfile", "w+")
f = File.new("newfile", File::CREAT|File::TRUNC|File::RDWR, 0644)
```

---

<b>open</b>	<code>File.open(<i>filename</i>, <i>modestring</i>="r")</code> → <i>file</i>
	<code>File.open(<i>filename</i> ⟨, <i>modenum</i> ⟨, <i>permission</i>⟩)⟩</code> → <i>file</i>
	<code>File.open(<i>fd</i> ⟨, <i>modenum</i> ⟨, <i>permission</i>⟩)⟩</code> → <i>file</i>
	<code>File.open(<i>filename</i>, <i>modestring</i>="r")</code> {   <i>file</i>   <i>block</i> } → <i>obj</i>
	<code>File.open(<i>filename</i> ⟨, <i>modenum</i> ⟨, <i>permission</i>⟩)⟩</code> {   <i>file</i>   <i>block</i> } → <i>obj</i>
	<code>File.open(<i>fd</i> ⟨, <i>modenum</i> ⟨, <i>permission</i>⟩)⟩</code> {   <i>file</i>   <i>block</i> } → <i>obj</i>

---

With no associated block, `open` is a synonym for `File.new`. If the optional code block is given, it will be passed *file* as an argument, and the file will automatically be closed when the block terminates. In this instance, `File.open` returns the value of the block.

---

<b>owned?</b>	<code>File.owned?(<i>filename</i>)</code> → true or false
---------------	-----------------------------------------------------------

---

Returns true if the effective user ID of the process is the same as the owner of the named file.

```
File.owned?("/etc/passwd") → false
```

---

<b>pipe?</b>	<code>File.pipe?(<i>filename</i>)</code> → true or false
--------------	----------------------------------------------------------

---

Returns true if the operating system supports pipes and the named file is a pipe, false otherwise.

```
File.pipe?("testfile") → false
```

---

<b>readable?</b>	<code>File.readable?(<i>filename</i>)</code> → true or false
------------------	--------------------------------------------------------------

---

Returns true if the named file is readable by the effective user ID of this process.

```
File.readable?("testfile") → true
```

---

<b>readable_real?</b>	<code>File.readable_real?(<i>filename</i>)</code> → true or false
-----------------------	-------------------------------------------------------------------

---

Returns true if the named file is readable by the real user ID of this process.

```
File.readable_real?("testfile") → true
```

---

<b>readlink</b>	<code>File.readlink(<i>filename</i>)</code> → <i>filename</i>
-----------------	---------------------------------------------------------------

---

Returns the given symbolic link as a string. Not available on all platforms.

```
File.symlink("testfile", "link2test") → 0
File.readlink("link2test") → "testfile"
```

Table 27.4. Open-mode constants

APPEND	Open the file in append mode; all writes will occur at end of file.
CREAT	Create the file on open if it does not exist.
EXCL	When used with CREAT, open will fail if the file exists.
NOCTTY	When opening a terminal device (see <code>IO#isatty</code> on page 489), do not allow it to become the controlling terminal.
NONBLOCK	Open the file in nonblocking mode.
RONLY	Open for reading only.
RDWR	Open for reading and writing.
TRUNC	Open the file and truncate it to zero length if the file exists.
WRONLY	Open for writing only.

---

**rename** `File.rename(oldname, newname)` → 0

---

Renames the given file or directory to the new name. Raises a `SystemCallError` if the file cannot be renamed.

```
File.rename("afile", "afile.bak") → 0
```

---

**setgid?** `File.setgid?(filename)` → true or false

---

Returns true if the named file's set-group-id permission bit is set, and returns false if it isn't or if the operating system doesn't support this feature.

```
File.setgid?("/usr/sbin/lpc") → false
```

---

**setuid?** `File.setuid?(filename)` → true or false

---

Returns true if the named file's set-user-id permission bit is set, and returns false if it isn't or if the operating system doesn't support this feature.

```
File.setuid?("/bin/su") → false
```

---

**size** `File.size(filename)` → int

---

Returns the size of the file in bytes.

```
File.size("testfile") → 66
```

---

**size?** `File.size?(filename)` → int or nil

---

Returns nil if the named file is of zero length; otherwise, returns the size. Usable as a condition in tests.

```
File.size?("testfile") → 66
```

```
File.size?("/dev/zero") → nil
```

---

**socket?** File.socket?(*filename*) → true or false

---

Returns true if the named file is a socket, and returns false if it isn't or if the operating system doesn't support this feature.

---

**split** File.split(*filename*) → array

---

Splits the given string into a directory and a file component and returns them in a two-element array. See also `File.dirname` and `File.basename`.

```
File.split("/home/gumby/.profile") → ["/home/gumby", ".profile"]
File.split("ruby.rb") → [".", "ruby.rb"]
```

---

**stat** File.stat(*filename*) → stat

---

Returns a `File::Stat` object for the named file (see `File::Stat`, page 456).

```
stat = File.stat("testfile")
stat.mtime → Thu Aug 26 12:33:23 CDT 2004
stat.blockdev? → false
stat.ftype → "file"
```

---

**sticky?** File.sticky?(*filename*) → true or false

---

Returns true if the named file has its sticky bit set, and returns false if it doesn't or if the operating system doesn't support this feature.

---

**symlink** File.symlink(*oldname*, *newname*) → 0 or nil

---

Creates a symbolic link called *newname* for the file *oldname*. Returns nil on all platforms that do not support symbolic links.

```
File.symlink("testfile", "link2test") → 0
```

---

**symlink?** File.symlink?(*filename*) → true or false

---

Returns true if the named file is a symbolic link, and returns false if it isn't or if the operating system doesn't support this feature.

```
File.symlink("testfile", "link2test") → 0
File.symlink?("link2test") → true
```

---

**truncate** File.truncate(*filename*, *int*) → 0

---

Truncates the file *filename* to be at most *int* bytes long. Not available on all platforms.

```
f = File.new("out", "w")
f.write("1234567890") → 10
f.close → nil
File.truncate("out", 5) → 0
File.size("out") → 5
```



---

**umask** File.umask( *< int >* ) → *int*

---

Returns the current umask value for this process. If the optional argument is given, set the umask to that value and return the previous value. Umask values are *excluded* from the default permissions; so a umask of 0222 would make a file read-only for everyone. See also the discussion of permissions on page 444.

```
File.umask(0006) → 18
File.umask → 6
```

---

**unlink** File.unlink( *< filename >*<sup>+</sup> ) → *int*

---

Synonym for File.delete. See also Dir.rmdir.

```
File.open("testrm", "w+") {} → nil
File.unlink("testrm") → 1
```

---

**utime** File.utime( *accesstime, modtime <, filename >*<sup>+</sup> ) → *int*

---

Changes the access and modification times on a number of files. The times must be instances of class Time or integers representing the number of seconds since epoch. Returns the number of files processed. Not available on all platforms.

```
File.utime(0, 0, "testfile") → 1
File.mtime("testfile") → Wed Dec 31 18:00:00 CST 1969
File.utime(0, Time.now, "testfile") → 1
File.mtime("testfile") → Thu Aug 26 22:37:33 CDT 2004
```

---

**writable?** File.writable?( *filename* ) → true or false

---

Returns true if the named file is writable by the effective user ID of this process.

```
File.writable?("/etc/passwd") → false
File.writable?("testfile") → true
```

---

**writable\_real?** File.writable\_real?( *filename* ) → true or false

---

Returns true if the named file is writable by the real user ID of this process.

---

**zero?** File.zero?( *filename* ) → true or false

---

Returns true if the named file is of zero length, and returns false otherwise.

```
File.zero?("testfile") → false
File.open("zerosize", "w") {}
File.zero?("zerosize") → true
```

## Instance methods

---

**atime** *file.atime* → *time*

Returns a Time object containing the last access time for *file*, or returns epoch if the file has not been accessed.

```
File.new("testfile").atime → Wed Dec 31 18:00:00 CST 1969
```

---

**chmod** *file.chmod( permission )* → 0

Changes permission bits on *file* to the bit pattern represented by *permission*. Actual effects are platform dependent; on Unix systems, see `chmod(2)` for details. Follows symbolic links. See the discussion of permissions on page 444. Also see `File#lchmod`.

```
f = File.new("out", "w");
f.chmod(0644) → 0
```

---

**chown** *file.chown( owner, group )* → 0

Changes the owner and group of *file* to the given numeric owner and group IDs. Only a process with superuser privileges may change the owner of a file. The current owner of a file may change the file's group to any group to which the owner belongs. A nil or -1 owner or group id is ignored. Follows symbolic links. See also `File#lchown`.

```
File.new("testfile").chown(502, 1000)
```

---

**ctime** *file.ctime* → *time*

Returns a Time object containing the time that the file status associated with *file* was changed.

```
File.new("testfile").ctime → Thu Aug 26 22:37:33 CDT 2004
```

---

**flock** *file.flock( locking\_constant )* → 0 or false

Locks or unlocks a file according to *locking\_constant* (a logical *or* of the values in Table 27.5 on the next page). Returns false if `File::LOCK_NB` is specified and the operation would otherwise have blocked. Not available on all platforms.

```
File.new("testfile").flock(File::LOCK_UN) → 0
```

---

**lchmod** *file.lchmod( permission )* → 0

1.8

Equivalent to `File#chmod`, but does not follow symbolic links (so it will change the permissions associated with the link, not the file referenced by the link). Often not available.

---

**lchown** *file.lchown( owner, group )* → 0

1.8

Equivalent to `File#chown`, but does not follow symbolic links (so it will change the owner associated with the link, not the file referenced by the link). Often not available.

Table 27.5. Lock-mode constants

LOCK_EX	Exclusive lock. Only one process may hold an exclusive lock for a given file at a time.
LOCK_NB	Don't block when locking. May be combined with other lock options using logical <i>or</i> .
LOCK_SH	Shared lock. Multiple processes may each hold a shared lock for a given file at the same time.
LOCK_UN	Unlock.

---

**lstat** *file.lstat* → *stat*

---

Same as `IO#stat`, but does not follow the last symbolic link. Instead, reports on the link itself.

```
File.symlink("testfile", "link2test") → 0
File.stat("testfile").size → 66
f = File.new("link2test")
f.lstat.size → 8
f.stat.size → 66
```

---

**mtime** *file.mtime* → *time*

---

Returns a `Time` object containing the modification time for *file*.

```
File.new("testfile").mtime → Thu Aug 26 22:37:33 CDT 2004
```

---

**path** *file.path* → *filename*

---

Returns the pathname used to create *file* as a string. Does not normalize the name.

```
File.new("testfile").path → "testfile"
File.new("/tmp/./tmp/xxx", "w").path → "/tmp/./tmp/xxx"
```

---

**truncate** *file.truncate(int)* → 0

---

Truncates *file* to at most *int* bytes. The file must be opened for writing. Not available on all platforms.

```
f = File.new("out", "w")
f.syswrite("1234567890") → 10
f.truncate(5) → 0
f.close() → nil
File.size("out") → 5
```

**Class** **File::Stat** < Object

Objects of class `File::Stat` encapsulate common status information for `File` objects. The information is recorded at the moment the `File::Stat` object is created; changes made to the file after that point will not be reflected. `File::Stat` objects are returned by `IO#stat`, `File.stat`, `File#lstat`, and `File.lstat`. Many of these methods may return platform-specific values, and not all values are meaningful on all systems. See also `Kernel#test` on page 510.

**Mixes in****Comparable:**

<, <=, ==, >=, >, between?

**Instance methods**

**<=>** *statfile <=> other\_stat* → -1, 0, 1

Compares `File::Stat` objects by comparing their respective modification times.

```
f1 = File.new("f1", "w")
sleep 1
f2 = File.new("f2", "w")
f1.stat <=> f2.stat → -1
Methods in Comparable are also available
f1.stat > f2.stat → false
f1.stat < f2.stat → true
```

**atime** *statfile.atime* → *time*

Returns a `Time` object containing the last access time for *statfile*, or returns epoch if the file has not been accessed.

```
File.stat("testfile").atime → Wed Dec 31 18:00:00 CST 1969
File.stat("testfile").atime.to_i → 0
```

**blksize** *statfile.blksize* → *int*

Returns the native file system's block size. Will return `nil` on platforms that don't support this information.

```
File.stat("testfile").blksize → 4096
```

**blockdev?** *statfile.blockdev?* → *true* or *false*

Returns `true` if the file is a block device, and returns `false` if it isn't or if the operating system doesn't support this feature.

```
File.stat("testfile").blockdev? → false
File.stat("/dev/disk0").blockdev? → true
```

---

**blocks** *statfile.blocks* → *int*

---

Returns the number of native file system blocks allocated for this file, or returns nil if the operating system doesn't support this feature.

```
File.stat("testfile").blocks → 8
```

---

**chardev?** *statfile.chardev?* → true or false

---

Returns true if the file is a character device, and returns false if it isn't or if the operating system doesn't support this feature.

```
File.stat("/dev/tty").chardev? → true
File.stat("testfile").chardev? → false
```

---

**ctime** *statfile.ctime* → *time*

---

Returns a Time object containing the time that the file status associated with *statfile* was changed.

```
File.stat("testfile").ctime → Thu Aug 26 22:37:33 CDT 2004
```

---

**dev** *statfile.dev* → *int*

---

Returns an integer representing the device on which *statfile* resides. The bits in the device integer will often encode major and minor device information.

```
File.stat("testfile").dev → 234881033
"%x" % File.stat("testfile").dev → "e000009"
```

---

**dev\_major** *statfile.dev\_major* → *int*

---

1.8 Returns the major part of `File::Stat#dev` or nil if the operating system doesn't support this feature.

```
File.stat("testfile").dev_major → 14
```

---

**dev\_minor** *statfile.dev\_minor* → *int*

---

1.8 Returns the minor part of `File::Stat#dev` or nil if the operating system doesn't support this feature.

```
File.stat("testfile").dev_minor → 9
```

---

**directory?** *statfile.directory?* → true or false

---

Returns true if *statfile* is a directory, and returns false otherwise.

```
File.stat("testfile").directory? → false
File.stat(".").directory? → true
```

---

**executable?** *statfile.executable?* → true or false

Returns true if *statfile* is executable or if the operating system doesn't distinguish executable files from nonexecutable files. The tests are made using the effective owner of the process.

```
File.stat("testfile").executable? → false
```

---

**executable\_real?** *statfile.executable\_real?* → true or false

Same as *executable?*, but tests using the real owner of the process.

---

**file?** *statfile.file?* → true or false

Returns true if *statfile* is a regular file (not a device file, pipe, socket, and so on).

```
File.stat("testfile").file? → true
```

---

**ftype** *statfile.ftype* → *type\_string*

Identifies the type of *statfile*. The return string is one of: file, directory, characterSpecial, blockSpecial, fifo, link, socket, or unknown.

```
File.stat("/dev/tty").ftype → "characterSpecial"
```

---

**gid** *statfile.gid* → *int*

Returns the numeric group ID of the owner of *statfile*.

```
File.stat("testfile").gid → 502
```

---

**grpowned?** *statfile.grpowned?* → true or false

Returns true if the effective group ID of the process is the same as the group ID of *statfile*. On Windows, returns false.

```
File.stat("testfile").grpowned? → true
File.stat("/etc/passwd").grpowned? → false
```

---

**ino** *statfile.ino* → *int*

Returns the inode number for *statfile*.

```
File.stat("testfile").ino → 422829
```

---

**mode** *statfile.mode* → *int*

Returns an integer representing the permission bits of *statfile*. The meaning of the bits is platform dependent; on Unix systems, see *stat(2)*.

```
File.chmod(0644, "testfile") → 1
File.stat("testfile").mode.to_s(8) → "100644"
```

---

**mtime** *statfile.mtime* → *time*

---

Returns a Time object containing the modification time for *statfile*.

```
File.stat("testfile").mtime → Thu Aug 26 22:37:33 CDT 2004
```

---

**nlink** *statfile.nlink* → *int*

---

Returns the number of hard links to *statfile*.

```
File.stat("testfile").nlink → 1
File.link("testfile", "testfile.bak") → 0
File.stat("testfile").nlink → 2
```

---

**owned?** *statfile.owned?* → *true* or *false*

---

Returns true if the effective user ID of the process is the same as the owner of *statfile*.

```
File.stat("testfile").owned? → true
File.stat("/etc/passwd").owned? → false
```

---

**pipe?** *statfile.pipe?* → *true* or *false*

---

Returns true if the operating system supports pipes and *statfile* is a pipe.

---

**rdev** *statfile.rdev* → *int*

---

Returns an integer representing the device type on which *statfile* (which should be a special file) resides. Returns nil if the operating system doesn't support this feature.

```
File.stat("/dev/disk0s1").rdev → 234881025
File.stat("/dev/tty").rdev → 33554432
```

---

**rdev\_major** *statfile.rdev\_major* → *int*

---

1.8 Returns the major part of `File::Stat#rdev` or nil if the operating system doesn't support this feature.

```
File.stat("/dev/disk0s1").rdev_major → 14
File.stat("/dev/tty").rdev_major → 2
```

---

**rdev\_minor** *statfile.rdev\_minor* → *int*

---

1.8 Returns the minor part of `File::Stat#rdev` or nil if the operating system doesn't support this feature.

```
File.stat("/dev/disk0s1").rdev_minor → 1
File.stat("/dev/tty").rdev_minor → 0
```

---

**readable?** *statfile.readable?* → *true* or *false*

---

Returns true if *statfile* is readable by the effective user ID of this process.

```
File.stat("testfile").readable? → true
```

---

**readable\_real?** *statfile.readable\_real?* → true or false

---

Returns true if *statfile* is readable by the real user ID of this process.

```
File.stat("testfile").readable_real? → true
File.stat("/etc/passwd").readable_real? → true
```

---

**setgid?** *statfile.setgid?* → true or false

---

Returns true if *statfile* has the set-group-id permission bit set, and returns false if it doesn't or if the operating system doesn't support this feature.

```
File.stat("testfile").setgid? → false
File.stat("/usr/sbin/postdrop").setgid? → true
```

---

**setuid?** *statfile.setuid?* → true or false

---

Returns true if *statfile* has the set-user-id permission bit set, and returns false if it doesn't or if the operating system doesn't support this feature.

```
File.stat("testfile").setuid? → false
File.stat("/usr/bin/su").setuid? → true
```

---

**size** *statfile.size* → int

---

Returns the size of *statfile* in bytes.

```
File.stat("/dev/zero").size → 0
File.stat("testfile").size → 66
```

---

**size?** *statfile.size?* → int or nil

---

Returns nil if *statfile* is a zero-length file; otherwise, returns the file size. Usable as a condition in tests.

```
File.stat("/dev/zero").size? → nil
File.stat("testfile").size? → 66
```

---

**socket?** *statfile.socket?* → true or false

---

Returns true if *statfile* is a socket, and returns false if it isn't or if the operating system doesn't support this feature.

```
File.stat("testfile").socket? → false
```

---

**sticky?** *statfile.sticky?* → true or false

---

Returns true if *statfile* has its sticky bit set, and returns false if it doesn't or if the operating system doesn't support this feature.

```
File.stat("testfile").sticky? → false
```



---

**symlink?** *statfile.symlink?* → true or false

---

Returns true if *statfile* is a symbolic link, false if it isn't or if the operating system doesn't support this feature. As `File.stat` automatically follows symbolic links, `symlink?` will always be false for an object returned by `File.stat`.

```
File.symlink("testfile", "alink") → 0
File.stat("alink").symlink? → false
File.lstat("alink").symlink? → true
```

---

**uid** *statfile.uid* → int

---

Returns the numeric user ID of the owner of *statfile*.

```
File.stat("testfile").uid → 502
```

---

**writable?** *statfile.writable?* → true or false

---

Returns true if *statfile* is writable by the effective user ID of this process.

```
File.stat("testfile").writable? → true
```

---

**writable\_real?** *statfile.writable\_real?* → true or false

---

Returns true if *statfile* is writable by the real user ID of this process.

```
File.stat("testfile").writable_real? → true
```

---

**zero?** *statfile.zero?* → true or false

---

Returns true if *statfile* is a zero-length file; false otherwise.

```
File.stat("testfile").zero? → false
```

**Module** **FileTest**

FileTest implements file test operations similar to those used in `File::Stat`. The methods in FileTest are duplicated in class `File`. Rather than repeat the documentation here, we list the names of the methods and refer you to the documentation for `File` starting on page 444. FileTest appears to a somewhat vestigial module.

The FileTest methods are

1.8 `blockdev?`, `chardev?`, `directory?`, `executable?`, `executable_real?`, `exist?`, `exists?`, `file?`, `grpowned?`, `owned?`, `pipe?`, `readable?`, `readable_real?`, `setgid?`, `setuid?`, `size`, `size?`, `socket?`, `sticky?`, `symlink?`, `world_readable?`, `world_writable?`, `writable?`, `writable_real?`, and `zero?`

**Class** **Fixnum** < Integer

A `Fixnum` holds `Integer` values that can be represented in a native machine word (minus 1 bit). If any operation on a `Fixnum` exceeds this range, the value is automatically converted to a `Bignum`.

`Fixnum` objects have immediate value. This means that when they are assigned or passed as parameters, the actual object is passed, rather than a reference to that object. Assignment does not alias `Fixnum` objects. As there is effectively only one `Fixnum` object instance for any given integer value, you cannot, for example, add a singleton method to a `Fixnum`.

**Instance methods****Arithmetic operations**

Performs various arithmetic operations on *fix*.

<i>fix</i>	+	<i>numeric</i>	Addition
<i>fix</i>	-	<i>numeric</i>	Subtraction
<i>fix</i>	*	<i>numeric</i>	Multiplication
<i>fix</i>	/	<i>numeric</i>	Division
<i>fix</i>	%	<i>numeric</i>	Modulo
<i>fix</i>	**	<i>numeric</i>	Exponentiation
<i>fix</i>	-@		Unary minus

**Bit operations**

Performs various operations on the binary representations of the `Fixnum`.

$\sim$ <i>fix</i>			Invert bits
<i>fix</i>		<i>numeric</i>	Bitwise OR
<i>fix</i>	&	<i>numeric</i>	Bitwise AND
<i>fix</i>	^	<i>numeric</i>	Bitwise EXCLUSIVE OR
<i>fix</i>	<<	<i>numeric</i>	Left-shift <i>numeric</i> bits
<i>fix</i>	>>	<i>numeric</i>	Right-shift <i>numeric</i> bits (with sign extension)

**<=>** *fix* <=> *numeric* → -1, 0, +1

Comparison—Returns -1, 0, or +1 depending on whether *fix* is less than, equal to, or greater than *numeric*. This is the basis for the tests in `Comparable`.

```
42 <=> 13 → 1
13 <=> 42 → -1
-1 <=> -1 → 0
```

---

**[ ]** *fix[ n ]* → 0, 1

Bit Reference—Returns the *n*th bit in the binary representation of *fix*, where *fix*[0] is the least significant bit.

```
a = 0b11001100101010
30.downto(0) { |n| print a[n] }
```

*produces:*

```
000000000000000000011001100101010
```

---

**abs** *fix.abs* → *int*

Returns the absolute value of *fix*.

```
-12345.abs → 12345
12345.abs → 12345
```

---

**div** *fix.div( numeric )* → *integer*

1.8

Synonym for Fixnum#/. Integer division always yields an integral result.

```
654321.div(13731) → 47
654321.div(13731.34) → 47
```

---

**divmod** *fix.divmod( numeric )* → *array*

See Numeric#divmod on page 544.

---

**id2name** *fix.id2name* → *string* or *nil*

Returns the name of the object whose symbol ID is *fix*. If there is no symbol in the symbol table with this value, returns *nil*. *id2name* has nothing to do with the Object.*id* method. See also Fixnum#to\_sym, String#intern on page 594, and class Symbol on page 610.

```
symbol = :@inst_var → :@inst_var
id = symbol.to_i → 9866
id.id2name → "@inst_var"
```

---

**modulo** *fix.modulo( numeric )* → *numeric*

1.8

Synonym for Fixnum#%.

```
654321.modulo(13731) → 8964
654321.modulo(13731.24) → 8952.72000000001
```

---

**quo** *fix.quo( numeric )* → *float*

1.8

Returns the floating-point result of dividing *fix* by *numeric*.

```
654321.quo(13731) → 47.6528293642124
654321.quo(13731.24) → 47.6519964693647
```

---

**size** *fix.size* → *int*

---

Returns the number of *bytes* in the machine representation of a Fixnum.

```
1.size → 4
-1.size → 4
2147483647.size → 4
```

---

**to\_f** *fix.to\_f* → *float*

---

Converts *fix* to a Float.

---

**to\_s** *fix.to\_s( base=10 )* → *string*

---

1.8 Returns a string containing the representation of *fix* radix *base* (2 to 36).

```
12345.to_s → "12345"
12345.to_s(2) → "11000000111001"
12345.to_s(8) → "30071"
12345.to_s(10) → "12345"
12345.to_s(16) → "3039"
12345.to_s(36) → "9ix"
84823723233035811745497171.to_s(36) → "anotherrubyhacker"
```

---

**to\_sym** *fix.to\_sym* → *symbol*

---

1.8 Returns the symbol whose integer value is *fix*. See also Fixnum#id2name.

```
fred = :fred.to_i
fred.id2name → "fred"
fred.to_sym → :fred
```

---

**zero?** *fix.zero?* → true or false

---

Returns true if *fix* is zero.

```
42.zero? → false
0.zero? → true
```

**Class** **Float** < Numeric

Float objects represent real numbers using the native architecture's double-precision floating-point representation.

**Class constants**

DIG	Precision of Float (in decimal digits)
EPSILON	The smallest Float such that $1.0 + \text{EPSILON} \neq 1.0$
MANT_DIG	The number of mantissa digits (base RADIX)
MAX	The largest Float
MAX_10_EXP	The maximum integer $x$ such that $10^x$ is a finite Float
MAX_EXP	The maximum integer $x$ such that $\text{FLT\_RADIX}^{(x-1)}$ is a finite Float
MIN	The smallest Float
MIN_10_EXP	The minimum integer $x$ such that $10^x$ is a finite Float
MIN_EXP	The minimum integer $x$ such that $\text{FLT\_RADIX}^{(x-1)}$ is a finite Float
RADIX	The radix of floating-point representations
ROUNDS	The rounding mode for floating-point operations. Possible values include <ul style="list-style-type: none"> <li>-1 if the mode is indeterminate</li> <li>0 if rounding is toward zero</li> <li>1 if rounding is to nearest representable value</li> <li>2 if rounding is toward <math>+\infty</math></li> <li>3 if rounding is toward <math>-\infty</math></li> </ul>

**Instance methods****Arithmetic operations**

Performs various arithmetic operations on *flt*.

<i>flt</i>	+	<i>numeric</i>	Addition
<i>flt</i>	-	<i>numeric</i>	Subtraction
<i>flt</i>	*	<i>numeric</i>	Multiplication
<i>flt</i>	/	<i>numeric</i>	Division
<i>flt</i>	%	<i>numeric</i>	Modulo
<i>flt</i>	**	<i>numeric</i>	Exponentiation
<i>flt</i>	-@		Unary minus

**<=>** *flt* <=> *numeric* → -1, 0, +1

Returns -1, 0, or +1 depending on whether *flt* is less than, equal to, or greater than *numeric*. This is the basis for the tests in Comparable.

---

**==** *flt == obj* → true or false

Returns true only if *obj* has the same value as *flt*. Contrast this with `Float#eql?`, which requires *obj* to be a Float.

```
1.0 == 1.0 → true
(1.0).eql?(1.0) → true
1.0 == 1 → true
(1.0).eql?(1) → false
```

---

**abs** *flt.abs* → numeric

Returns the absolute value of *flt*.

```
(-34.56).abs → 34.56
-34.56.abs → 34.56
```

---

**ceil** *flt.ceil* → int

Returns the smallest Integer greater than or equal to *flt*.

```
1.2.ceil → 2
2.0.ceil → 2
(-1.2).ceil → -1
(-2.0).ceil → -2
```

---

**divmod** *flt.divmod(numeric)* → array

See `Numeric#divmod` on page 544.

---

**eql?** *flt.eql?(obj)* → true or false

Returns true only if *obj* is a Float with the same value as *flt*. Contrast this with `Float#==`, which performs type conversions.

```
1.0.eql?(1) → false
1.0 == 1 → true
```

---

**finite?** *flt.finite?* → true or false

Returns true if *flt* is a valid IEEE floating-point number (it is not infinite, and `nan?` is false).

```
(42.0).finite? → true
(1.0/0.0).finite? → false
```

---

**floor** *flt.floor* → int

Returns the largest integer less than or equal to *flt*.

```
1.2.floor → 1
2.0.floor → 2
(-1.2).floor → -2
(-2.0).floor → -2
```

---

**infinite?** *flt.infinite?* → nil, -1, +1

---

Returns nil, -1, or +1 depending on whether *flt* is finite,  $-\infty$ , or  $+\infty$ .

```
(0.0).infinite? → nil
(-1.0/0.0).infinite? → -1
(+1.0/0.0).infinite? → 1
```

---

**modulo** *flt.modulo( numeric )* → numeric

---

1.8 Synonym for Float#%.

```
6543.21.modulo(137) → 104.21
6543.21.modulo(137.24) → 92.92999999999996
```

---

**nan?** *flt.nan?* → true or false

---

Returns true if *flt* is an invalid IEEE floating-point number.

```
(-1.0).nan? → false
(0.0/0.0).nan? → true
```

---

**round** *flt.round* → int

---

Rounds *flt* to the nearest integer. Equivalent to

```
def round
 case
 when self > 0.0 then (self+0.5).floor
 when self < 0.0 then return (self-0.5).ceil
 else 0
 end
end
```

```
1.5.round → 2
(-1.5).round → -2
```

---

**to\_f** *flt.to\_f* → *flt*

---

Returns *flt*.

---

**to\_i** *flt.to\_i* → int

---

Returns *flt* truncated to an Integer.

```
1.5.to_i → 1
(-1.5).to_i → -1
```

---

**to\_int** *flt.to\_int* → int

---

Synonym for Float#to\_i.



---

**to\_s** *flt.to\_s* → *string*

---

Returns a string containing a representation of self. As well as a fixed or exponential form of the number, the call may return NaN, Infinity, and -Infinity.

---

**truncate** *flt.truncate* → *int*

---

1.8    Synonym for Float#to\_i.

---

**zero?** *flt.zero?* → true or false

---

Returns true if *flt* is 0.0.

**Module GC**

The GC module provides an interface to Ruby's mark and sweep garbage collection mechanism. Some of the underlying methods are also available via the ObjectSpace module, described beginning on page [557](#).

**Module methods**

---

**disable** GC.disable → true or false

Disables garbage collection, returning true if garbage collection was already disabled.

```
GC.disable → false
GC.disable → true
```

---

**enable** GC.enable → true or false

Enables garbage collection, returning true if garbage collection was disabled.

```
GC.disable → false
GC.enable → true
GC.enable → false
```

---

**start** GC.start → nil

Initiates garbage collection, unless manually disabled.

```
GC.start → nil
```

**Instance methods**

---

**garbage\_collect** garbage\_collect → nil

Equivalent to GC.start.

```
include GC
garbage_collect → nil
```

**Class** Hash < Object

A Hash is a collection of key/value pairs. It is similar to an Array, except that indexing is done via arbitrary keys of any object type, not an integer index. The order in which keys and/or values are returned by the various iterators over hash contents may seem arbitrary and will generally not be in insertion order.

Hashes have a *default value*. This value is returned when an attempt is made to access keys that do not exist in the hash. By default, this value is `nil`.

**Mixes in****Enumerable:**

`all?`, `any?`, `collect`, `detect`, `each_with_index`, `entries`, `find`, `find_all`,  
`grep`, `include?`, `inject`, `map`, `max`, `member?`, `min`, `partition`, `reject`,  
`select`, `sort`, `sort_by`, `to_a`, `zip`

**Class methods**

**[ ]** Hash[ < key => value >\* ] → *hsh*

Creates a new hash populated with the given objects. Equivalent to creating a hash using the literal { *key=>value*, ... }. Keys and values occur in pairs, so there must be an even number of arguments.

```
Hash["a", 100, "b", 200] → {"a"=>100, "b"=>200}
Hash["a" => 100, "b" => 200] → {"a"=>100, "b"=>200}
{"a" => 100, "b" => 200 } → {"a"=>100, "b"=>200}
```

**new** Hash.new → *hsh*  
 Hash.new( *obj* ) → *hsh*  
 Hash.new { |*hash*, *key* | *block* } → *hsh*

1.8

Returns a new, empty hash. If this hash is subsequently accessed by a key that doesn't correspond to a hash entry, the value returned depends on the style of `new` used to create the hash. In the first form, the access returns `nil`. If *obj* is specified, this single object will be used for all *default values*. If a block is specified, it will be called with the hash object and the key, and it should return the default value. It is the block's responsibility to store the value in the hash if required.

```
h = Hash.new("Go Fish")
h["a"] = 100
h["b"] = 200
h["a"] → 100
h["c"] → "Go Fish"
The following alters the single default object
h["c"].upcase! → "GO FISH"
h["d"] → "GO FISH"
h.keys → ["a", "b"]
```

```
While this creates a new default object each time
h = Hash.new {|hash, key| hash[key] = "Go Fish: #{key}"}
h["c"] → "Go Fish: c"
h["c"].upcase! → "GO FISH: C"
h["d"] → "Go Fish: d"
h.keys → ["c", "d"]
```

## Instance methods

**==** *hsh == obj* → true or false

Equality—Two hashes are equal if they have the same default value, they contain the same number of keys, and the value corresponding to each key in the first hash is equal (using ==) to the value for the same key in the second. If *obj* is not a hash, attempt to convert it using `to_hash` and return `obj == hsh`.

```
h1 = { "a" => 1, "c" => 2 }
h2 = { 7 => 35, "c" => 2, "a" => 1 }
h3 = { "a" => 1, "c" => 2, 7 => 35 }
h4 = { "a" => 1, "d" => 2, "f" => 35 }
h1 == h2 → false
h2 == h3 → true
h3 == h4 → false
```

**[]** *hsh[ key ]* → value

Element Reference—Retrieves the *value* stored for *key*. If not found, returns the default value (see `Hash.new` for details).

```
h = { "a" => 100, "b" => 200 }
h["a"] → 100
h["c"] → nil
```

**[]=** *hsh[ key ] = value* → value

Element Assignment—Associates the value given by *value* with the key given by *key*. *key* should not have its value changed while it is in use as a key (a String passed as a key will be duplicated and frozen).

```
h = { "a" => 100, "b" => 200 }
h["a"] = 9
h["c"] = 4
h → {"a"=>9, "b"=>200, "c"=>4}
```

**clear** *hsh.clear* → hsh

Removes all key/value pairs from *hsh*.

```
h = { "a" => 100, "b" => 200 } → {"a"=>100, "b"=>200}
h.clear → {}
```

---

**default** *hsh.default( key=nil ) → obj*

---

1.8 Returns the default value, the value that would be returned by *hsh[key]* if *key* did not exist in *hsh*. See also `Hash.new` and `Hash#default=`.

```

h = Hash.new → {}
h.default → nil
h.default(2) → nil

h = Hash.new("cat") → {}
h.default → "cat"
h.default(2) → "cat"

h = Hash.new {|h,k| h[k] = k.to_i*10} → {}
h.default → 0
h.default(2) → 20

```

---

**default=** *hsh.default = obj → hsh*

---

Sets the default value, the value returned for a key that does not exist in the hash. It is not possible to set the a default to a Proc that will be executed on each key lookup.

```

h = { "a" => 100, "b" => 200 }
h.default = "Go fish"
h["a"] → 100
h["z"] → "Go fish"
This doesn't do what you might hope...
h.default = proc do |hash, key|
 hash[key] = key + key
end
h[2] → #<Proc:0x001c94e0@-:6>
h["cat"] → #<Proc:0x001c94e0@-:6>

```

---

**default\_proc** *hsh.default\_proc → obj or nil*

---

1.8 If `Hash.new` was invoked with a block, return that block; otherwise return `nil`.

```

h = Hash.new {|h,k| h[k] = k*k } → {}
p = h.default_proc → #<Proc:0x001c997c@-:1>
a = [] → []
p.call(a, 2) → [nil, nil, 4]
a → [nil, nil, 4]

```

---

**delete** *hsh.delete( key ) → value*  
*hsh.delete( key ) { |key| block } → value*

---

1.8 Deletes from *hsh* the entry whose key is to *key*, returning the corresponding value. If the key is not found, returns `nil`. If the optional code block is given and the key is not found, pass it the key and return the result of *block*.

```

h = { "a" => 100, "b" => 200 }
h.delete("a") → 100
h.delete("z") → nil
h.delete("z") {|e| "#{e} not found" } → "z not found"

```

---

**delete\_if** *hsh.delete\_if {|key, value| block } → hsh*

---

Deletes every key/value pair from *hsh* for which *block* is true.

```

h = { "a" => 100, "b" => 200, "c" => 300 }
h.delete_if {|key, value| key >= "b" } → {"a"=>100}

```

---

**each** *hsh.each {|key, value| block } → hsh*

---

Calls *block* once for each key in *hsh*, passing the key and value as parameters.

```

h = { "a" => 100, "b" => 200 }
h.each {|key, value| puts "#{key} is #{value}" }

```

*produces:*

```

a is 100
b is 200

```

---

**each\_key** *hsh.each\_key {|key| block } → hsh*

---

Calls *block* once for each key in *hsh*, passing the key as a parameter.

```

h = { "a" => 100, "b" => 200 }
h.each_key {|key| puts key }

```

*produces:*

```

a
b

```

---

**each\_pair** *hsh.each\_pair {|key, value| block } → hsh*

---

Synonym for Hash#each.

---

**each\_value** *hsh.each\_value {|value| block } → hsh*

---

Calls *block* once for each key in *hsh*, passing the value as a parameter.

```

h = { "a" => 100, "b" => 200 }
h.each_value {|value| puts value }

```

*produces:*

```

100
200

```

---

**empty?** *hsh.empty? → true or false*

---

Returns true if *hsh* contains no key/value pairs.

```

{}.empty? → true

```

**fetch**

*hsh.fetch( key <, default > ) → obj*  
*hsh.fetch( key ) { |key| block } → obj*

Returns a value from the hash for the given key. If the key can't be found, several options exist: With no other arguments, it will raise an `IndexError` exception; if *default* is given, then that will be returned; if the optional code block is specified, then that will be run and its result returned. `fetch` does not evaluate any default values supplied when the hash was created—it only looks for keys in the hash.

```
h = { "a" => 100, "b" => 200 }
h.fetch("a") → 100
h.fetch("z", "go fish") → "go fish"
h.fetch("z") {|el| "go fish, #{el}"} → "go fish, z"
```

The following example shows that an exception is raised if the key is not found and a default value is not supplied.

```
h = { "a" => 100, "b" => 200 }
h.fetch("z")

produces:

prog.rb:2:in `fetch': key not found (IndexError)
from prog.rb:2
```

**has\_key?**

*hsh.has\_key?( key ) → true or false*

Returns true if the given key is present in *hsh*.

```
h = { "a" => 100, "b" => 200 }
h.has_key?("a") → true
h.has_key?("z") → false
```

**has\_value?**

*hsh.has\_value?( value ) → true or false*

Returns true if the given value is present for some key in *hsh*.

```
h = { "a" => 100, "b" => 200 }
h.has_value?(100) → true
h.has_value?(999) → false
```

**include?**

*hsh.include?( key ) → true or false*

Synonym for `Hash#has_key?`.

**index**

*hsh.index( value ) → key*

Searches the hash for an entry whose value == *value*, returning the corresponding key. If multiple entries has this value, the key returned will be that on one of the entries. If not found, returns `nil`.

```
h = { "a" => 100, "b" => 200 }
h.index(200) → "b"
h.index(999) → nil
```

---

**indexes** *hsh.indexes( <key>+ ) → array*

---

1.8 Deprecated in favor of Hash#values\_at.

---

**indices** *hsh.indices( <key>+ ) → array*

---

1.8 Deprecated in favor of Hash#values\_at.

---

**invert** *hsh.invert → other\_hash*

---

Returns a new hash created by using *hsh*'s values as keys, and the keys as values. If *hsh* has duplicate values, the result will contain only one of them as a key—which one is not predictable.

```
h = { "n" => 100, "m" => 100, "y" => 300, "d" => 200, "a" => 0 }
h.invert → {0=>"a", 100=>"n", 200=>"d", 300=>"y"}
```

---

**key?** *hsh.key?(key) → true or false*

---

Synonym for Hash#has\_key?.

---

**keys** *hsh.keys → array*

---

Returns a new array populated with the keys from this hash. See also Hash#values.

```
h = { "a" => 100, "b" => 200, "c" => 300, "d" => 400 }
h.keys → ["a", "b", "c", "d"]
```

---

**length** *hsh.length → fixnum*

---

Returns the number of key/value pairs in the hash.

```
h = { "d" => 100, "a" => 200, "v" => 300, "e" => 400 }
h.length → 4
h.delete("a") → 200
h.length → 3
```

---

**member?** *hsh.member?(key) → true or false*

---

Synonym for Hash#has\_key?.

---

**merge** *hsh.merge(other\_hash) → result\_hash*

---

*hsh.merge(other\_hash) {|key, old\_val, new\_val| block } → result\_hash*

1.8 Returns a new hash containing the contents of *other\_hash* and the contents of *hsh*. With no block parameter, overwrites entries in *hsh* with duplicate keys with those from *other\_hash*. If a block is specified, it is called with each duplicate key and the values from the two hashes. The value returned by the block is stored in the new hash. ▶▶▶



```

h1 = { "a" => 100, "b" => 200 }
h2 = { "b" => 254, "c" => 300 }
h1.merge(h2) → {"a"=>100, "b"=>254, "c"=>300}
h1.merge(h2) {|k,o,n| o} → {"a"=>100, "b"=>200, "c"=>300}
h1 → {"a"=>100, "b"=>200}

```

---

**merge!** *hsh.merge!( other\_hash ) → hsh*  
*hsh.merge!( other\_hash ) {|key, old\_val, new\_val| block } → hsh*

---

1.8 Adds the contents of *other\_hash* to *hsh*, overwriting entries with duplicate keys with those from *other\_hash*.

```

h1 = { "a" => 100, "b" => 200 }
h2 = { "b" => 254, "c" => 300 }
h1.merge!(h2) → {"a"=>100, "b"=>254, "c"=>300}
h1 = { "a" => 100, "b" => 200 }
h1.merge!(h2) {|k,o,n| o} → {"a"=>100, "b"=>200, "c"=>300}
h1 → {"a"=>100, "b"=>200, "c"=>300}

```

---

**rehash** *hsh.rehash → hsh*

---

Rebuilds the hash based on the current hash values for each key. If values of key objects have changed since they were inserted, this method will reindex *hsh*. If `Hash#rehash` is called while an iterator is traversing the hash, an `IndexError` will be raised in the iterator.

```

a = ["a", "b"]
c = ["c", "d"]
h = { a => 100, c => 300 }
h[a] → 100
a[0] = "z"
h[a] → nil
h.rehash → [{"z", "b"}=>100, [{"c", "d"}=>300}
h[a] → 100

```

---

**reject** *hsh.reject {|key, value| block } → hash*

---

Same as `Hash#delete_if`, but works on (and returns) a copy of *hsh*. Equivalent to *hsh.dup.delete\_if*.

---

**reject!** *hsh.reject! {|key, value| block } → hsh or nil*

---

Equivalent to `Hash#delete_if`, but returns `nil` if no changes were made.

---

**replace** *hsh.replace( other\_hash ) → hsh*

---

Replaces the contents of *hsh* with the contents of *other\_hash*.

```

h = { "a" => 100, "b" => 200 }
h.replace({ "c" => 300, "d" => 400 }) → {"c"=>300, "d"=>400}

```

---

**select** *hsh.select { |key, value| block } → array*

---

Returns a new array consisting of [key, value] pairs for which the block returns true. Also see Hash#values\_at.

```
h = { "a" => 100, "b" => 200, "c" => 300 }
h.select {|k,v| k > "a"} → [{"b", 200}, {"c", 300}]
h.select {|k,v| v < 200} → [{"a", 100}]
```

---

**shift** *hsh.shift → array or nil*

---

1.9

Removes a key/value pair from *hsh* and returns it as the two-item array [ key, value ]. If the hash is empty, returns the default value, calls the default proc (with a key value of nil), or returns nil.

```
h = { 1 => "a", 2 => "b", 3 => "c" }
h.shift → [1, "a"]
h → {2=>"b", 3=>"c"}
```

---

**size** *hsh.size → fixnum*

---

Synonym for Hash#length.

---

**sort** *hsh.sort → array*  
*hsh.sort { |a, b| block } → array*

---

Converts *hsh* to a nested array of [ key, value ] arrays and sorts it, using Array#sort.

```
h = { "a" => 20, "b" => 30, "c" => 10 }
h.sort → [{"a", 20}, {"b", 30}, {"c", 10}]
h.sort { |a,b| a[1]<=>b[1]} → [{"c", 10}, {"a", 20}, {"b", 30}]
```

---

**store** *hsh.store( key, value ) → value*

---

Synonym for Element Assignment (Hash#[ ]=).

---

**to\_a** *hsh.to\_a → array*

---

Converts *hsh* to a nested array of [ key, value ] arrays.

```
h = { "c" => 300, "a" => 100, "d" => 400, "c" => 300 }
h.to_a → [{"a", 100}, {"c", 300}, {"d", 400}]
```

---

**to\_hash** *hsh.to\_hash → hsh*

---

See page [356](#).

---

**to\_s** *hsh.to\_s → string*

---

Converts *hsh* to a string by converting the hash to an array of [ key, value ] pairs and then converting that array to a string using Array#join with the default separator.

```
h = { "c" => 300, "a" => 100, "d" => 400, "c" => 300 }
h.to_s → "a100c300d400"
```

---

**update** *hsh.update( other\_hash ) → hsh*  
*hsh.update( other\_hash ) { |key, old\_val, new\_val| block } → hsh*

---

1.8 ⚡ Synonym for Hash#merge!.

---

**value?** *hsh.value?( value ) → true or false*

---

Synonym for Hash#has\_value?.

---

**values** *hsh.values → array*

---

Returns an array populated with the values from *hsh*. See also Hash#keys.

```
h = { "a" => 100, "b" => 200, "c" => 300 }
h.values → [100, 200, 300]
```

---

**values\_at** *hsh.values\_at( <key>+ ) → array*

---

1.8 ⚡ Returns an array consisting of values for the given key(s). Will insert the *default value* for keys that are not found.

```
h = { "a" => 100, "b" => 200, "c" => 300 }
h.values_at("a", "c") → [100, 300]
h.values_at("a", "c", "z") → [100, 300, nil]
h.default = "cat"
h.values_at("a", "c", "z") → [100, 300, "cat"]
```

**Class** Integer < Numeric

Subclasses: Bignum, Fixnum

Integer is the basis for the two concrete classes that hold whole numbers, Bignum and Fixnum. (If you've come here looking for the iterator step, it's on page 545.)

**Instance methods**

---

**ceil** *int.ceil* → *integer*

---

Synonym for Integer#to\_i.

---

**chr** *int.chr* → *string*

---

Returns a string containing the ASCII character represented by the receiver's value.

```
65.chr → "A"
?a.chr → "a"
230.chr → "\346"
```

---

**downto** *int.downto(integer) {|i| block}* → *int*

---

Iterates *block*, passing decreasing values from *int* down to and including *integer*.

```
5.downto(1) {|n| print n, ".. " }
print " Liftoff!\n"
```

*produces:*

```
5.. 4.. 3.. 2.. 1.. Liftoff!
```

---

**floor** *int.floor* → *integer*

---

Returns the largest integer less than or equal to *int*. Equivalent to Integer#to\_i.

```
1.floor → 1
(-1).floor → -1
```

---

**integer?** *int.integer?* → true

---

Always returns true.

---

**next** *int.next* → *integer*

---

Returns the Integer equal to *int* + 1.

```
1.next → 2
(-1).next → 0
```

---

**round** *int.round* → *integer*

---

Synonym for Integer#to\_i.

---

**succ** *int.succ* → *integer*

---

Synonym for Integer#next.

---

**times** *int.times* { |i| *block* } → *int*

---

Iterates *block* *int* times, passing in values from zero to *int* - 1.

```
5.times do |i|
 print i, " "
end
```

*produces:*

0 1 2 3 4

---

**to\_i** *int.to\_i* → *int*

---

Returns *int*.

---

**to\_int** *int.to\_int* → *integer*

---

Synonym for Integer#to\_i.

---

**truncate** *int.truncate* → *integer*

---

Synonym for Integer#to\_i.

---

**upto** *int.upto*( *integer* ) { |i| *block* } → *int*

---

Iterates *block*, passing in integer values from *int* up to and including *integer*.

```
5.upto(10) { |i| print i, " " }
```

*produces:*

5 6 7 8 9 10

## Class IO < Object

Subclasses: File

Class IO is the basis for all input and output in Ruby. An I/O stream may be *duplexed* (that is, bidirectional) and so may use more than one native operating system stream.

Many of the examples in this section use class File, the only standard subclass of IO. The two classes are closely associated.

As used in this section, *portname* may take any of the following forms.

- A plain string represents a filename suitable for the underlying operating system.
- A string starting with | indicates a subprocess. The remainder of the string following the | is invoked as a process with appropriate input/output channels connected to it.
- A string equal to |- will create another Ruby instance as a subprocess.

The IO class uses the Unix abstraction of *file descriptors*, small integers that represent open files. Conventionally, standard input has an fd of 0, standard output an fd of 1, and standard error an fd of 2.

Ruby will convert pathnames between different operating system conventions if possible. For instance, on a Windows system the filename `/gumby/ruby/test.rb` will be opened as `\gumby\ruby\test.rb`. When specifying a Windows-style filename in a double-quoted Ruby string, remember to escape the backslashes.

```
"c:\\gumby\\ruby\\test.rb"
```

Our examples here will use the Unix-style forward slashes; `File::SEPARATOR` can be used to get the platform-specific separator character.

I/O ports may be opened in any one of several different modes, which are shown in this section as *modestring*. This mode string must be one of the values listed in Table 27.6 on the following page.

## Mixes in

### Enumerable:

```
all?, any?, collect, detect, each_with_index, entries, find, find_all,
grep, include?, inject, map, max, member?, min, partition, reject,
select, sort, sort_by, to_a, zip
```

Table 27.6. Mode strings

Mode	Meaning
r	Read-only, starts at beginning of file (default mode).
r+	Read/write, starts at beginning of file.
w	Write-only, truncates an existing file to zero length or creates a new file for writing.
w+	Read/write, truncates existing file to zero length or creates a new file for reading and writing.
a	Write-only, starts at end of file if file exists; otherwise creates a new file for writing.
a+	Read/write, starts at end of file if file exists; otherwise creates a new file for reading and writing.
b	(DOS/Windows only) Binary file mode (may appear with any of the key letters listed above).

## Class methods

**for\_fd** IO.for\_fd( *int*, *modestring* ) → *io*

1.8    Synonym for IO.new.

**foreach** IO.foreach( *portname*, *separator*=\$/ ) { *line* | *block* } → nil

Executes the block for every line in the named I/O port, where lines are separated by *separator*.

```
IO.foreach("testfile") {|x| puts "GOT: #{x}" }
```

*produces:*

```
GOT: This is line one
GOT: This is line two
GOT: This is line three
GOT: And so on...
```

**new** IO.new( *int*, *modestring* ) → *io*

Returns a new IO object (a stream) for the given integer file descriptor and mode string. See also IO#fileno and IO.for\_fd.

```
a = IO.new(2, "w") # '2' is standard error
STDERR.puts "Hello"
a.puts "World"
```

*produces:*

```
Hello
World
```

**open**

IO.open( *int*, *modestring* ) → *io*  
 IO.open( *int*, *modestring* ) { | *io* | *block* } → *obj*

With no associated block, `open` is a synonym for `IO.new`. If the optional code block is given, it will be passed `io` as an argument, and the IO object will automatically be closed when the block terminates. In this instance, `IO.open` returns the value of the block.

```
IO.open(1, "w") do |io|
 io.puts "Writing to stdout"
end
```

*produces:*

Writing to stdout

**pipe**

IO.pipe → *array*

Creates a pair of pipe endpoints (connected to each other) and returns them as a two-element array of IO objects: [ *read\_file*, *write\_file* ]. *write\_file* is automatically placed into sync mode. Not available on all platforms.

In the example below, the two processes close the ends of the pipe that they are not using. This is not just a cosmetic nicety. The read end of a pipe will not generate an end-of-file condition if any writers have the pipe still open. In the case of the parent process, the `rd.read` will never return if it does not first issue a `wr.close`.

```
rd, wr = IO.pipe
if fork
 wr.close
 puts "Parent got: <#{rd.read}>"
 rd.close
 Process.wait
else
 rd.close
 puts "Sending message to parent"
 wr.write "Hi Dad"
 wr.close
end
```

*produces:*

Sending message to parent  
 Parent got: <Hi Dad>

**popen**

IO.popen( *cmd*, *modestring*="r" ) → *io*  
 IO.popen( *cmd*, *modestring*="r" ) { | *io* | *block* } → *obj*

Runs the specified command string as a subprocess; the subprocess's standard input and output will be connected to the returned IO object. The parameter `cmd` may be a string or an array of strings. In the latter case, the array is used as the `argv` parameter for the new process, and no special shell processing is performed on the strings. If `cmd`



is a string, it will be subject to shell expansion. If the *cmd* string starts with a minus sign (-), and the operating system supports `fork(2)`, then the current Ruby process is forked. The default mode for the new file object is `r`, but *modestring* may be set to any of the modes in Table 27.6 on page 483.

If a block is given, Ruby will run the command as a child connected to Ruby with a pipe. Ruby's end of the pipe will be passed as a parameter to the block. In this case `IO.popen` returns the value of the block.

If a block is given with a *cmd\_string* of "-", the block will be run in two separate processes: once in the parent and once in a child. The parent process will be passed the pipe object as a parameter to the block, the child version of the block will be passed `nil`, and the child's standard in and standard out will be connected to the parent through the pipe. Not available on all platforms. Also see the `Open3` library on page 687 and `Kernel#exec` on page 500.

```
pipe = IO.popen("uname")
p(pipe.readlines)
puts "Parent is #{Process.pid}"
IO.popen("date") {|pipe| puts pipe.gets }
IO.popen("-") {|pipe| STDERR.puts "#{Process.pid} is here, pipe=#{pipe}" }
```

*produces:*

```
["Darwin\n"]
Parent is 26841
Thu Aug 26 22:37:42 CDT 2004
26844 is here, pipe=
26841 is here, pipe=#<IO:0x1c9418>
```

---

**read** `IO.read(portname, <length=$/ <, offset > >)` → *string*

1.8

Opens the file, optionally seeks to the given offset, and then returns *length* bytes (defaulting to the rest of the file). `read` ensures the file is closed before returning.

```
IO.read("testfile") → "This is line one\nThis is line
two\nThis is line three\nAnd so
on...\n"
IO.read("testfile", 20) → "This is line one\nThi"
IO.read("testfile", 20, 10) → "ne one\nThis is line "
```

---

**readlines** `IO.readlines(portname, separator=$/)` → *array*

Reads the entire file specified by *portname* as individual lines, and returns those lines in an array. Lines are separated by *separator*.

```
a = IO.readlines("testfile")
a[0] → "This is line one\n"
```

---

**select** IO.select(*read\_array* ⟨, *write\_array* ⟨, *error\_array* ⟨, *timeout* ⟩ ⟩) → *array*  
or *nil*

---

See Kernel#select on page 507.

---

**sysopen** IO.sysopen(*path*, ⟨*mode* ⟨, *perm* ⟩ ⟩) → *int*

---

1.8 Opens the given path, returning the underlying file descriptor as a Fixnum.

IO.sysopen("testfile") → 3

## Instance methods

---

**<<** *io* << *obj* → *io*

---

String Output—Writes *obj* to *io*. *obj* will be converted to a string using `to_s`.

```
STDOUT << "Hello " << "world!\n"
```

*produces:*

```
Hello world!
```

---

**binmode** *io*.binmode → *io*

---

Puts *io* into binary mode. This is useful only in MS-DOS/Windows environments. Once a stream is in binary mode, it cannot be reset to nonbinary mode.

---

**clone** *io*.clone → *io*

---

Creates a new I/O stream, copying all the attributes of *io*. The file position is shared as well, so reading from the clone will alter the file position of the original, and vice versa.

---

**close** *io*.close → *nil*

---

Closes *io* and flushes any pending writes to the operating system. The stream is unavailable for any further data operations; an IOError is raised if such an attempt is made. I/O streams are automatically closed when they are claimed by the garbage collector.

---

**close\_read** *io*.close\_read → *nil*

---

Closes the read end of a duplex I/O stream (i.e., one that contains both a read and a write stream, such as a pipe). Will raise an IOError if the stream is not duplexed.

```
f = IO.popen("/bin/sh", "r+")
```

```
f.close_read
```

```
f.readlines
```

*produces:*

```
prog.rb:3:in `readlines': not opened for reading (IOError)
```

```
from prog.rb:3
```

---

**close\_write** *io.close\_write* → nil

---

Closes the write end of a duplex I/O stream (i.e., one that contains both a read and a write stream, such as a pipe). Will raise an IOError if the stream is not duplexed.

```
f = IO.popen("/bin/sh", "r+")
f.close_write
f.print "nowhere"
```

*produces:*

```
prog.rb:3:in `write': not opened for writing (IOError)
from prog.rb:3:in `print'
from prog.rb:3
```

---

**closed?** *io.closed?* → true or false

---

Returns true if *io* is completely closed (for duplex streams, both reader and writer), and returns false otherwise.

```
f = File.new("testfile")
f.close → nil
f.closed? → true
f = IO.popen("/bin/sh", "r+")
f.close_write → nil
f.closed? → false
f.close_read → nil
f.closed? → true
```

---

**each** *io.each( separator=\$/ ) { |line| block } → io*

---

Executes the block for every line in *io*, where lines are separated by *separator*. *io* must be opened for reading or an IOError will be raised.

```
f = File.new("testfile")
f.each { |line| puts "#{f.lineno}: #{line}" }
```

*produces:*

```
1: This is line one
2: This is line two
3: This is line three
4: And so on...
```

---

**each\_byte** *io.each\_byte { |byte| block } → nil*

---

Calls the given block once for each byte (a Fixnum in the range 0 to 255) in *io*, passing the byte as an argument. The stream must be opened for reading or an IOError will be raised.

```
f = File.new("testfile")
checksum = 0
f.each_byte { |x| checksum ^= x } → #<File:testfile>
checksum → 12
```

---

**each\_line** *io.each\_line( separator=\$/ ) { |line| block } → io*

---

Synonym for IO#each.

---

**eof** *io.eof → true or false*

---

Returns true if *io* is at end of file. The stream must be opened for reading or an IOError will be raised.

```
f = File.new("testfile")
dummy = f.readlines
f.eof → true
```

---

**eof?** *io.eof? → true or false*

---

Synonym for IO#eof.

---

**fcntl** *io.fcntl( cmd, arg ) → int*

---

Provides a mechanism for issuing low-level commands to control or query file-oriented I/O streams. Commands (which are integers), arguments, and the result are platform dependent. If *arg* is a number, its value is passed directly. If it is a string, it is interpreted as a binary sequence of bytes. On Unix platforms, see `fcntl(2)` for details. The `Fcntl` module provides symbolic names for the first argument (see page 656). Not implemented on all platforms.

---

**fileno** *io.fileno → int*

---

Returns an integer representing the numeric file descriptor for *io*.

```
STDIN.fileno → 0
STDOUT.fileno → 1
```

---

**flush** *io.flush → io*

---

Flushes any buffered data within *io* to the underlying operating system (note that this is Ruby internal buffering only; the OS may buffer the data as well).

```
STDOUT.print "no newline"
STDOUT.flush
```

*produces:*

no newline

---

**fsync** *io.fsync → 0 or nil*

---

1.8

Immediately writes all buffered data in *io* to disk. Returns `nil` if the underlying operating system does not support `fsync(2)`. Note that `fsync` differs from using `IO#sync=`. The latter ensures that data is flushed from Ruby's buffers but does not guarantee that the underlying operating system actually writes it to disk.

---

**getc** *io.getc* → *int* or *nil*

---

Gets the next 8-bit byte (0..255) from *io*. Returns *nil* if called at end of file.

```
f = File.new("testfile")
f.getc → 84
f.getc → 104
```

---

**gets** *io.gets( separator=\$/ )* → *string* or *nil*

---

Reads the next “line” from the I/O stream; lines are separated by *separator*. A separator of *nil* reads the entire contents, and a zero-length separator reads the input a paragraph at a time (two successive newlines in the input separate paragraphs). The stream must be opened for reading or an *IOError* will be raised. The line read in will be returned and also assigned to *\$\_*. Returns *nil* if called at end of file.

```
File.new("testfile").gets → "This is line one\n"
$_ → "This is line one\n"
```

---

**ioctl** *io.ioctl( cmd, arg )* → *int*

---

Provides a mechanism for issuing low-level commands to control or query I/O devices. The command (which is an integer), arguments, and results are platform dependent. If *arg* is a number, its value is passed directly. If it is a string, it is interpreted as a binary sequence of bytes. On Unix platforms, see `ioctl(2)` for details. Not implemented on all platforms.

---

**isatty** *io.isatty* → *true* or *false*

---

Returns *true* if *io* is associated with a terminal device (*tty*), and returns *false* otherwise.

```
File.new("testfile").isatty → false
File.new("/dev/tty").isatty → true
```

---

**lineno** *io.lineno* → *int*

---

Returns the current line number in *io*. The stream must be opened for reading. *lineno* counts the number of times *gets* is called, rather than the number of newlines encountered. The two values will differ if *gets* is called with a separator other than newline. See also the *\$.* variable.

```
f = File.new("testfile")
f.lineno → 0
f.gets → "This is line one\n"
f.lineno → 1
f.gets → "This is line two\n"
f.lineno → 2
```

---

**lineno=** *io.lineno = int → int*

---

Manually sets the current line number to the given value. \$. is updated only on the next read.

```
f = File.new("testfile")
f.gets → "This is line one\n"
$. → 1
f.lineno = 1000
f.lineno → 1000
$. # lineno of last read → 1
f.gets → "This is line two\n"
$. # lineno of last read → 1001
```

---

**pid** *io.pid → int*

---

Returns the process ID of a child process associated with *io*. This will be set by `IO.popen`.

```
pipe = IO.popen("-")
if pipe
 STDERR.puts "In parent, child pid is #{pipe.pid}"
else
 STDERR.puts "In child, pid is #{$$}"
end
```

*produces:*

```
In child, pid is 26884
In parent, child pid is 26884
```

---

**pos** *io.pos → int*

---

Returns the current offset (in bytes) of *io*.

```
f = File.new("testfile")
f.pos → 0
f.gets → "This is line one\n"
f.pos → 17
```

---

**pos=** *io.pos = int → 0*

---

Seeks to the given position (in bytes) in *io*.

```
f = File.new("testfile")
f.pos = 17
f.gets → "This is line two\n"
```

---

**print** *io.print( <obj=\$\_>\* ) → nil*

---

Writes the given object(s) to *io*. The stream must be opened for writing. If the output record separator (\$\n) is not nil, it will be appended to the output. If no arguments are given, prints \$\_. Objects that aren't strings will be converted by calling their `to_s` method. Returns nil.



```
STDOUT.print("This is ", 100, " percent.\n")
```

*produces:*

```
This is 100 percent.
```

---

**printf** *io.printf(format <, obj>\*) → nil*

---

Formats and writes to *io*, converting parameters under control of the format string. See `Kernel#sprintf` on page 508 for details.

---

**putc** *io.putc(obj) → obj*

---

Writes the given character (taken from a `String` or a `Fixnum`) on *io*.

```
STDOUT.putc "A"
STDOUT.putc 65
```

*produces:*

```
AA
```

---

**puts** *io.puts(<obj>\*) → nil*

---

Writes the given objects to *io* as with `IO#print`. Writes a newline after any that do not already end with a newline sequence. If called with an array argument, writes each element on a new line. If called without arguments, outputs a single newline.

```
STDOUT.puts("this", "is", "a", "test")
```

*produces:*

```
this
is
a
test
```

---

**read** *io.read(<int <, buffer>)> → string or nil*

---

1.8

Reads at most *int* bytes from the I/O stream or to the end of file if *int* is omitted. Returns `nil` if called at end of file. If *buffer* (a `String`) is provided, it is resized accordingly and input is read directly in to it.

```
f = File.new("testfile")
f.read(16) → "This is line one"
str = "cat"
f.read(10, str) → "\nThis is l"
str → "\nThis is l"
```

---

**readchar** *io.readchar → int*

---

Reads a character as with `IO#getc`, but raises an `EOFError` on end of file.

---

**readline** *io.readline(separator=\$/) → string*

---

Reads a line as with `IO#gets`, but raises an `EOFError` on end of file.

---

**readlines** *io.readlines( separator=\$/ ) → array*

---

Reads all of the lines in *io*, and returns them in *array*. Lines are separated by the optional *separator*. The stream must be opened for reading or an `IOError` will be raised.

```
f = File.new("testfile")
f.readlines → ["This is line one\n", "This is line two\n", "This
 is line three\n", "And so on...\n"]
```

---

**reopen** *io.reopen( other\_io ) → io*  
*io.reopen( path, modestring ) → io*

---

Reassociates *io* with the I/O stream given in *other\_io* or to a new stream opened on *path*. This may dynamically change the actual class of this stream.

```
f1 = File.new("testfile")
f2 = File.new("testfile")
f2.readlines[0] → "This is line one\n"
f2.reopen(f1) → #<File:testfile>
f2.readlines[0] → "This is line one\n"
```

---

**rewind** *io.rewind → 0*

---

Positions *io* to the beginning of input, resetting `lineno` to zero.

```
f = File.new("testfile")
f.readline → "This is line one\n"
f.rewind → 0
f.lineno → 0
f.readline → "This is line one\n"
```

---

**seek** *io.seek( int, whence=SEEK\_SET ) → 0*

---

Seeks to a given offset *int* in the stream according to the value of *whence*.

---

`IO::SEEK_CUR` Seeks to *int* plus current position.  
`IO::SEEK_END` Seeks to *int* plus end of stream (you probably want a negative value for *int*).  
`IO::SEEK_SET` Seeks to the absolute location given by *int*.

---

```
f = File.new("testfile")
f.seek(-13, IO::SEEK_END) → 0
f.readline → "And so on...\n"
```

---

**stat** *io.stat → stat*

---

Returns status information for *io* as an object of type `File::Stat`.



```
f = File.new("testfile")
s = f.stat
"%o" % s.mode → "100644"
s.blksize → 4096
s.atime → Thu Aug 26 22:37:41 CDT 2004
```

---

**sync** *io.sync* → true or false

---

Returns the current “sync mode” of *io*. When sync mode is true, all output is immediately flushed to the underlying operating system and is not buffered by Ruby internally. See also `IO#fsync`.

```
f = File.new("testfile")
f.sync → false
```

---

**sync=** *io.sync = bool* → true or false

---

Sets the “sync mode” to true or false. When sync mode is true, all output is immediately flushed to the underlying operating system and is not buffered internally. Returns the new state. See also `IO#fsync`.

```
f = File.new("testfile")
f.sync = true
```

---

**sysread** *io.sysread(int <, buffer >)* → string

---

1.8 Reads *int* bytes from *io* using a low-level read and returns them as a string. If *buffer* (a String) is provided, input is read directly in to it. Do not mix with other methods that read from *io*, or you may get unpredictable results. Raises `SystemCallError` on error and `EOFError` at end of file.

```
f = File.new("testfile")
f.sysread(16) → "This is line one"
str = "cat"
f.sysread(10, str) → "\nThis is l"
str → "\nThis is l"
```

---

**sysseek** *io.sysseek(offset, whence=SEEK\_SET)* → int

---

1.8 Seeks to a given *offset* in the stream according to the value of *whence* (see `IO#seek` for values of *whence*). Returns the new offset into the file.

```
f = File.new("testfile")
f.sysseek(-13, IO::SEEK_END) → 53
f.sysread(10) → "And so on."
```

---

**syswrite** *io.syswrite(string)* → int

---

Writes the given string to *io* using a low-level write. Returns the number of bytes written. Do not mix with other methods that write to *io*, or you may get unpredictable results. Raises `SystemCallError` on error.

```
f = File.new("out", "w")
f.syswrite("ABCDEF") → 6
```

---

**tell** *io.tell* → *int*

---

Synonym for IO#pos.

---

**to\_i** *io.to\_i* → *int*

---

Synonym for IO#fileno.

---

**to\_io** *io.to\_io* → *io*

---

Returns *io*.

---

**tty?** *io.tty?* → true or false

---

Synonym for IO#isatty.

---

**ungetc** *io.ungetc(int)* → nil

---

Pushes back one character onto *io*, such that a subsequent buffered read will return it. Only one character may be pushed back before a subsequent read operation (that is, you will be able to read only the last of several characters that have been pushed back). Has no effect with unbuffered reads (such as IO#sysread).

```
f = File.new("testfile") → #<File:testfile>
c = f.getc → 84
f.ungetc(c) → nil
f.getc → 84
```

---

**write** *io.write(string)* → *int*

---

Writes the given string to *io*. The stream must be opened for writing. If the argument is not a string, it will be converted to a string using *to\_s*. Returns the number of bytes written.

```
count = STDOUT.write("This is a test\n")
puts "That was #{count} bytes of data"
```

*produces:*

```
This is a test
That was 15 bytes of data
```

**Module Kernel**

The Kernel module is included by class Object, so its methods are available in every Ruby object. The Kernel instance methods are documented in class Object beginning on page 546. This section documents the module methods. These methods are called without a receiver and thus can be called in functional form.

**Module methods**

---

**Array** Array(*arg*) → *array*

---

Returns *arg* as an Array. First tries to call *arg*.to\_ary, then *arg*.to\_a. If both fail, creates a single element array containing *arg* (unless *arg* is nil).

```
Array(1..5) → [1, 2, 3, 4, 5]
```

---

**Float** Float(*arg*) → *float*

---

1.8

Returns *arg* converted to a float. Numeric types are converted directly, the rest are converted using *arg*.to\_f. As of Ruby 1.8, converting nil generates a TypeError.

```
Float(1) → 1.0
Float("123.456") → 123.456
```

---

**Integer** Integer(*arg*) → *int*

---

Converts *arg* to a Fixnum or Bignum. Numeric types are converted directly (floating-point numbers are truncated). If *arg* is a String, leading radix indicators (0, 0b, and 0x) are honored. Others are converted using to\_int and to\_i. This behavior is different from that of String#to\_i.

```
Integer(123.999) → 123
Integer("0x1a") → 26
Integer(Time.new) → 1093577888
Integer(nil) → 0
```

---

**String** String(*arg*) → *string*

---

Converts *arg* to a String by calling its to\_s method.

```
String(self) → "main"
String(self.class) → "Object"
String(123456) → "123456"
```

---

**`(backquote)`** ``cmd`` returns *string*

---

Returns the standard output of running *cmd* in a subshell. The built-in syntax `%x{...}` described on page 83 uses this method. Sets \$? to the process status.

```

`date` → "Thu Aug 26 22:38:08 CDT 2004\n"
`ls testdir`.split[1] → "main.rb"
`echo oops && exit 99` → "oops\n"
`$?.exitstatus` → 99

```

---

**abort** abort  
abort(*msg*)

---

1.8 Terminates execution immediately with an exit code of 1. The optional String parameter is written to standard error before the program terminates.

---

**at\_exit** at\_exit { *block* } → *proc*

---

Converts *block* to a Proc object (and therefore binds it at the point of call), and registers it for execution when the program exits. If multiple handlers are registered, they are executed in reverse order of registration.

```

def do_at_exit(str1)
 at_exit { print str1 }
end
at_exit { puts "cruel world" }
do_at_exit("goodbye ")
exit

```

*produces:*

```
goodbye cruel world
```

---

**autoload** autoload(*name*, *file\_name*) → nil

---

Registers *file\_name* to be loaded (using `Kernel.require`) the first time that the module *name* (which may be a String or a symbol) is accessed.

```
autoload(:MyModule, "/usr/local/lib/modules/my_module.rb")
```

1.8 Prior to Ruby 1.8, the *name* parameter was assumed to be in the top-level namespace. In Ruby 1.8, the new method `Module autoload` lets you define namespace-specific autoload hooks. In the following code, Ruby 1.6 will load `xxx.rb` on references to `::XXX` whereas Ruby 1.8 will autoload on references to `X::XXX`.

```

module X
 autoload :XXX, "xxx.rb"
end

```

Note that `xxx.rb` should define a class in the correct namespace. That is, in this example `xxx.rb` should contain

```

class X::XXX
 # ...
end

```

---

**autoload?** autoload?( *name* ) → *file\_name* or nil

---

1.8 Returns the name of the file that will be autoloaded when the string or symbol *name* is referenced in the top-level context, or returns nil if there is no associated autoload.

```
autoload(:Fred, "module_fred") → nil
autoload?(:Fred) → "module_fred"
autoload?(:Wilma) → nil
```

---

**binding** binding → *a\_binding*

---

Returns a Binding object, describing the variable and method bindings at the point of call. This object can be used when calling eval to execute the evaluated command in this environment. Also see the description of class Binding beginning on page 423.

```
def get_binding(param)
 return binding
end
b = get_binding("hello")
eval("param", b) → "hello"
```

---

**block\_given?** block\_given? → true or false

---

Returns true if yield would execute a block in the current context.

```
def try
 if block_given?
 yield
 else
 "no block"
 end
end
try → "no block"
try { "hello" } → "hello"
try do "hello" end → "hello"
```

---

**callcc** callcc { |*cont* | *block* } → *obj*

---

Generates a Continuation object, which it passes to the associated block. Performing a *cont.call* will cause the callcc to return (as will falling through the end of the block). The value returned by the callcc is the value of the block or the value passed to *cont.call*. See Continuation on page 427 for more details. Also see Kernel.throw for an alternative mechanism for unwinding a call stack.

---

**caller** caller( <*int*> ) → array

---

Returns the current execution stack—an array containing strings in the form *file:line* or *file:line: in 'method'*. The optional *int* parameter determines the number of initial stack entries to omit from the result.

```
def a(skip)
 caller(skip)
end
def b(skip)
 a(skip)
end
def c(skip)
 b(skip)
end
c(0) → ["prog:2:in `a'", "prog:5:in `b'", "prog:8:in `c'",
 "prog:10"]
c(1) → ["prog:5:in `b'", "prog:8:in `c'", "prog:11"]
c(2) → ["prog:8:in `c'", "prog:12"]
c(3) → ["prog:13"]
```

---

**catch** catch(*symbol*) { *block* } → obj

---

catch executes its block. If a throw is encountered, Ruby searches up its stack for a catch block with a tag corresponding to the throw's *symbol*. If found, that block is terminated, and catch returns the value given to throw. If throw is not called, the block terminates normally, and the value of catch is the value of the last expression evaluated. catch expressions may be nested, and the throw call need not be in lexical scope.

```
def routine(n)
 puts n
 throw :done if n <= 0
 routine(n-1)
end
catch(:done) { routine(4) }
```

*produces:*

```
4
3
2
1
0
```

---

**chomp** chomp( *rs* ) → \$\_ or string

---

Equivalent to `$_ = $_.chomp(rs)`, except no assignment is made if `chomp` doesn't change `$_`. See `String#chomp` on page 589.

```
$_ = "now\n"
chomp → "now"
chomp "ow" → "n"
chomp "xxx" → "n"
$_ → "n"
```

---

**chomp!** chomp!( *rs* ) → \$\_ or nil

---

Equivalent to `$_ = $_.chomp!(rs)`. See `String#chomp!`



```

$_ = "now\n"
chomp! → "now"
$_ → "now"
chomp! "x" → nil
$_ → "now"

```

---

**chop**

*chop* → *string*

(Almost) equivalent to `($_.dup).chomp!`, except that if chop would perform no action, `$_` is unchanged and `nil` is not returned. See `String#chop!` on page 589.

```

$_ = a = "now\r\n"
chop → "now"
$_ → "now"
chop → "no"
chop → "n"
chop → ""
a → "now\r\n"

```

---

**chop!**

*chop!* → *\$\_* or *nil*

Equivalent to `$_ . chop!`.

```

$_ = a = "now\r\n"
chop! → "now"
chop! → "no"
chop! → "n"
chop! → ""
chop! → nil
$_ → ""
a → ""

```

---

**eval**

*eval(string <, binding <, file <, line >>>)* → *obj*

Evaluates the Ruby expression(s) in *string*. If *binding* is given, the evaluation is performed in its context. The binding may be a `Binding` object or a `Proc` object. If the optional *file* and *line* parameters are present, they will be used when reporting syntax errors.

```

def get_binding(str)
 return binding
end
str = "hello"
eval "str + ' Fred'" → "hello Fred"
eval "str + ' Fred'", get_binding("bye") → "bye Fred"

```

1.8

As of Ruby 1.8, local variables assigned within an `eval` are available after the `eval` only if they were defined at the outer scope before the `eval` executed. In this way `eval` has the same scoping rules as blocks.

```

a = 1
eval "a = 98; b = 99"
puts a
puts b

```

*produces:*

```
98
prog.rb:4: undefined local variable or method `b' for
main:Object (NameError)
```

---

**exec**

*exec( command <, args >)*

Replaces the current process by running the given external command. If `exec` is given a single argument, that argument is taken as a line that is subject to shell expansion before being executed. If *command* contains a newline or any of the characters `*?{}[]<>()~\&|\$;'\`"`, or under Windows if *command* looks like a shell-internal command (for example `dir`), *command* is run under a shell. On Unix system, Ruby does this by prepending `sh -c`. Under Windows, it uses the name of a shell in either `RUBYSHELL` or `COMSPEC`.

If multiple arguments are given, the second and subsequent arguments are passed as parameters to *command* with no shell expansion. If the first argument is a two-element array, the first element is the command to be executed, and the second argument is used as the `argv[0]` value, which may show up in process listings. In MSDOS environments, the command is executed in a subshell; otherwise, one of the `exec(2)` system calls is used, so the running command may inherit some of the environment of the original program (including open file descriptors). Raises `SystemCallError` if the *command* couldn't execute (typically `Errno::ENOENT`).

```
exec "echo *" # echoes list of files in current directory
never get here
exec "echo", "*" # echoes an asterisk
never get here
```

---

**exit**

*exit( true | false | status=1 )*

1.8

Initiates the termination of the Ruby script. If called in the scope of an exception handler, raises a `SystemExit` exception. This exception may be caught. Otherwise exits the process using `exit(2)`. The optional parameter is used to return a status code to the invoking environment. With an argument of `true`, exits with a status of zero. With an argument that is `false` (or no argument), exits with a status of 1, otherwise exits with the given status. Note that the default exit value has changed from `-1` to `+1` in Ruby 1.8.

1.8

```
fork { exit 99 }
Process.wait
puts "Child exits with status: #{$.exitstatus}"
begin
 exit
 puts "never get here"
rescue SystemExit
 puts "rescued a SystemExit exception"
end
puts "after begin block"
```



*produces:*

```
Child exits with status: 99
rescued a SystemExit exception
after begin block
```

Just prior to termination, Ruby executes any `at_exit` functions and runs any object finalizers (see `ObjectSpace` beginning on page 557).

```
at_exit { puts "at_exit function" }
ObjectSpace.define_finalizer("string", lambda { puts "in finalizer" })
exit
```

*produces:*

```
at_exit function
in finalizer
```

---

**exit!** exit!( true | false | status=1 )

1.8 Similar to `Kernel.exit`, but exception handling, `at_exit` functions, and finalizers are bypassed.

---

**fail** fail  
fail( message )  
fail( exception < , message < , array > )

Synonym for `Kernel.raise`.

---

**fork** fork < { block } > → int or nil

Creates a subprocess. If a block is specified, that block is run in the subprocess, and the subprocess terminates with a status of zero. Otherwise, the `fork` call returns twice, once in the parent, returning the process ID of the child, and once in the child, returning `nil`. The child process can exit using `Kernel.exit!` to avoid running any `at_exit` functions. The parent process should use `Process.wait` to collect the termination statuses of its children or use `Process.detach` to register disinterest in their status; otherwise, the operating system may accumulate zombie processes.

```
fork do
 3.times {|i| puts "Child: #{i}" }
end
3.times {|i| puts "Parent: #{i}" }
Process.wait
```

*produces:*

```
Child: 0
Parent: 0
Child: 1
Parent: 1
Child: 2
Parent: 2
```

---

**format** format(*format\_string* ⟨, *arg*)\* ) → *string*

---

Synonym for Kernel.sprintf.

---

**gets** gets(*separator*=\$/ ) → *string* or nil

---

Returns (and assigns to \$\_) the next line from the list of files in ARGV (or \$\*) or from standard input if no files are present on the command line. Returns nil at end of file. The optional argument specifies the record separator. The separator is included with the contents of each record. A separator of nil reads the entire contents, and a zero-length separator reads the input one paragraph at a time, where paragraphs are divided by two consecutive newlines. If multiple filenames are present in ARGV, gets(nil) will read the contents one file at a time.

```
ARGV << "testfile"
print while gets
```

*produces:*

```
This is line one
This is line two
This is line three
And so on...
```

The style of programming using \$\_ as an implicit parameter is gradually losing favor in the Ruby community.

---

**global\_variables** global\_variables → *array*

---

Returns an array of the names of global variables.

```
global_variables.grep /std/ → ["$stdout", "$stdin", "$stderr"]
```

---

**gsub** gsub(*pattern*, *replacement*) → *string*  
gsub(*pattern*) { *block* } → *string*

---

Equivalent to \$\_.gsub(...), except that \$\_ will be updated if substitution occurs.

```
$_ = "quick brown fox"
gsub /[aeiou]/, '*' → "q**ck br*wn f*x"
$_ → "q**ck br*wn f*x"
```

---

**gsub!** gsub!(*pattern*, *replacement*) → *string* or nil  
gsub!(*pattern*) { *block* } → *string* or nil

---

Equivalent to \$\_.gsub!(...).

```
$_ = "quick brown fox"
gsub! /cat/, '*' → nil
$_ → "quick brown fox"
```

---

**iterator?** iterator? → true or false

---

Deprecated synonym for `Kernel.block_given?`.

---

**lambda** lambda { *block* } → *proc*

---

1.8

Creates a new procedure object from the given block. See page 342 for an explanation of the difference between procedure objects created using `lambda` and those created using `Proc.new`. Note that `lambda` is now preferred over `proc`.

```
prc = lambda { "hello" }
prc.call → "hello"
```

---

**load** load(*file\_name*, *wrap*=false) → true

---

Loads and executes the Ruby program in the file *file\_name*. If the filename does not resolve to an absolute path, the file is searched for in the library directories listed in `$:`. If the optional *wrap* parameter is `true`, the loaded script will be executed under an anonymous module, protecting the calling program's global namespace. In no circumstance will any local variables in the loaded file be propagated to the loading environment.

---

**local\_variables** local\_variables → array

---

Returns the names of the current local variables.

```
fred = 1
for i in 1..10
 # ...
end
local_variables → ["fred", "i"]
```

Note that local variables are associated with bindings.

```
def fred
 a = 1
 b = 2
 binding
end
freds_binding = fred
eval("local_variables", freds_binding) → ["a", "b"]
```

---

**loop** loop { *block* }

---

Repeatedly executes the block.

```
loop do
 print "Input: "
 break if (line = gets).nil? or (line =~ /^[qQ]/)
 # ...
end
```

---

**open** `open(name <, modestring <, permission >>) → io or nil`  
`open(name <, modestring <, permission >>) {|io| block } → obj`

---

Creates an IO object connected to the given stream, file, or subprocess.

1.8 If *name* does not start with a pipe character (|), treat it as the name of a file to open using the specified mode defaulting to "r" (see the table of valid modes on page 483). If a file is being created, its initial permissions may be set using the integer third parameter. If this third parameter is present, the file will be opened using the low-level `open(2)` rather than `fopen(3)` call.

1.8 If a block is specified, it will be invoked with the IO object as a parameter, which will be automatically closed when the block terminates. The call returns the value of the block in this case.

If *name* starts with a pipe character, a subprocess is created, connected to the caller by a pair of pipes. The returned IO object may be used to write to the standard input and read from the standard output of this subprocess. If the command following the | is a single minus sign, Ruby forks, and this subprocess is connected to the parent. In the subprocess, the `open` call returns `nil`. If the command is not "-", the subprocess runs the command. If a block is associated with an `open("|-")` call, that block will be run twice—once in the parent and once in the child. The block parameter will be an IO object in the parent and `nil` in the child. The parent's IO object will be connected to the child's STDIN and STDOUT. The subprocess will be terminated at the end of the block.

```
open("testfile") do |f|
 print f.gets
end
```

*produces:*

This is line one

Open a subprocess and read its output.

```
cmd = open("|date")
print cmd.gets
cmd.close
```

*produces:*

Thu Aug 26 22:38:10 CDT 2004

Open a subprocess running the same Ruby program.

```
f = open("|-", "w+")
if f.nil?
 puts "in Child"
 exit
else
 puts "Got: #{f.gets}"
end
```

*produces:*

Got: in Child

Open a subprocess using a block to receive the I/O object.

```
open("|-") do |f|
 if f.nil?
 puts "in Child"
 else
 puts "Got: #{f.gets}"
 end
end
```

*produces:*

Got: in Child

---

**p** p( < obj >+ ) → nil

---

For each object, writes *obj.inspect* followed by the current output record separator to the program's standard output. Also see the PrettyPrint library on page 695.

```
S = Struct.new(:name, :state)
s = S['dave', 'TX']
p s

produces:
#<struct S name="dave", state="TX">
```

---

**print** print( < obj >\* ) → nil

---

1.8

Prints each object in turn to STDOUT. If the output field separator (\$,) is not nil, its contents will appear between each field. If the output record separator (\$\) is not nil, it will be appended to the output. If no arguments are given, prints \$\_. Objects that aren't strings will be converted by calling their to\_s method.

```
print "cat", [1,2,3], 99, "\n"
$, = ", "
$\ = "\n"
print "cat", [1,2,3], 99
```

*produces:*

```
cat12399
cat, 1, 2, 3, 99
```

---

**printf** printf( io, format < , obj >\* ) → nil  
printf( format < , obj >\* ) → nil

---

Equivalent to

```
io.write sprintf(format, obj ...)
```

or

```
STDOUT.write sprintf(format, obj ...)
```

---

**proc** proc { *block* } → *a\_proc*

---

1.8

Creates a new procedure object from the given block. Mildly deprecated in favor of Kernel#lambda.

```
prc = proc { |name| "Goodbye, #{name}" }
prc.call('Dave') → "Goodbye, Dave"
```

---

**putc** putc( *int* ) → *int*

---

Equivalent to STDOUT.putc(*int*).

---

**puts** puts( < *arg* )\* ) → nil

---

Equivalent to STDOUT.puts(*arg...*).

---

**raise** raise  
raise( *message* )  
raise( *exception* < , *message* < , *array* >> )

---

With no arguments, raises the exception in \$! or raises a RuntimeError if \$! is nil. With a single String argument, raises a RuntimeError with the string as a message. Otherwise, the first parameter should be the name of an Exception class (or an object that returns an Exception when sent exception). The optional second parameter sets the message associated with the exception, and the third parameter is an array of call-back information. Exceptions are caught by the rescue clause of begin...end blocks.

```
raise "Failed to create socket"
raise ArgumentError, "No parameters", caller
```

---

**rand** rand( *max=0* ) → *number*

---

Converts *max* to an integer using  $max_1 = max.to_i.abs$ . If the result is zero, returns a pseudorandom floating-point number greater than or equal to 0.0 and less than 1.0. Otherwise, returns a pseudorandom integer greater than or equal to zero and less than *max*<sub>1</sub>. Kernel.srand may be used to ensure repeatable sequences of random numbers between different runs of the program. Ruby currently uses a modified Mersenne Twister with a period of  $2^{19937} - 1$ .

```
srand 1234 → 0
[rand, rand] → [0.191519450163469, 0.49766366626136]
[rand(10), rand(1000)] → [6, 817]
srand 1234 → 1234
[rand, rand] → [0.191519450163469, 0.49766366626136]
```

---

**readline** readline( < *separator=\$/* ) → *string*

---

Equivalent to Kernel.gets, except readline raises EOFError at end of file.

---

**readlines** readlines( *separator* ) → array

---

Returns an array containing the lines returned by calling `Kernel.gets(separator)` until the end of file.

---

**require** require( *library\_name* ) → true or false

---

Ruby tries to load *library\_name*, returning true if successful. If the filename does not resolve to an absolute path, it will be searched for in the directories listed in `$.:`. If the file has the extension `.rb`, it is loaded as a source file; if the extension is `.so`, `.o`, or `.dll`,<sup>1</sup> Ruby loads the shared library as a Ruby extension. Otherwise, Ruby tries adding `.rb`, `.so`, and so on to the name. The name of the loaded feature is added to the array in `$.`. A feature will not be loaded if its name already appears in `$.`.<sup>2</sup> `require` returns true if the feature was successfully loaded.

```
require 'my-library.rb'
require 'db-driver'
```

1.8 The `SCRIPT_LINES__` constant can be used to capture the source of code read using `require`.

```
SCRIPT_LINES__ = {}
require 'code/scriptlines'
puts "Files: #{SCRIPT_LINES__.keys.join(', ')}"
SCRIPT_LINES__['./code/scriptlines.rb'].each do |line|
 puts "Source: #{line}"
end
```

*produces:*

```
3/8
Files: ./code/scriptlines.rb, /Users/dave/ruby1.8/lib/ruby/1.8/rational.rb
Source: require 'rational'
Source:
Source: puts Rational(1,2)*Rational(3,4)
```

---

**scan** scan( *pattern* ) → array  
scan( *pattern* ) { *block* } → \$\_

---

Equivalent to calling `$.scan`. See `String#scan` on page 596.

---

**select** select( *read\_array* < , *write\_array* < , *error\_array* < , *timeout* > > ) → array or nil

---

Performs a low-level `select` call, which waits for data to become available from input/output devices. The first three parameters are arrays of IO objects or `nil`. The last is a timeout in seconds, which should be an Integer or a Float. The call waits

- 
1. Or whatever the default shared library extension is on the current platform.
  2. Although this name is not converted to an absolute path, so that `require 'a';require './a'` will load `a.rb` twice. This is arguably a bug.

for data to become available for any of the IO objects in *read\_array*, for buffers to have cleared sufficiently to enable writing to any of the devices in *write\_array*, or for an error to occur on the devices in *error\_array*. If one or more of these conditions are met, the call returns a three-element array containing arrays of the IO objects that were ready. Otherwise, if there is no change in status for *timeout* seconds, the call returns *nil*. If all parameters are *nil*, the current thread sleeps forever.

```
select([STDIN], nil, nil, 1.5) → [[#<IO:0x1cfaac>], [], []]
```

---

**set\_trace\_func** set\_trace\_func(*proc*) → *proc*  
set\_trace\_func(*nil*) → *nil*

---

Establishes *proc* as the handler for tracing, or disables tracing if the parameter is *nil*. *proc* takes up to six parameters: an event name, a filename, a line number, an object ID, a binding, and the name of a class. *proc* is invoked whenever an event occurs. Events are *c-call* (call a C-language routine), *c-return* (return from a C-language routine), *call* (call a Ruby method), *class* (start a class or module definition), *end* (finish a class or module definition), *line* (execute code on a new line), *raise* (raise an exception), and *return* (return from a Ruby method). Tracing is disabled within the context of *proc*.

See the example starting on page 393 for more information.

---

**sleep** sleep(*numeric*=0) → *fixnum*

---

Suspends the current thread for *numeric* seconds (which may be a *Float* with fractional seconds). Returns the actual number of seconds slept (rounded), which may be less than that asked for if the thread was interrupted by a *SIGALRM* or if another thread calls *Thread#run*. An argument of zero causes *sleep* to sleep forever.

```
Time.now → Thu Aug 26 22:38:10 CDT 2004
sleep 1.9 → 2
Time.now → Thu Aug 26 22:38:12 CDT 2004
```

---

**split** split( <*pattern* <, *limit*> ) → *array*

---

Equivalent to `$.split(pattern, limit)`. See *String#split* on page 598.

---

**sprintf** sprintf(*format\_string* <, *arguments*>\*) → *string*

---

Returns the string resulting from applying *format\_string* to any additional arguments. Within the format string, any characters other than format sequences are copied to the result.

A format sequence consists of a percent sign, followed by optional flags, width, and precision indicators, and then terminated with a field type character. The field type controls how the corresponding *sprintf* argument is to be interpreted, and the flags



modify that interpretation. The flag characters are shown in Table 27.7 on the following page, and the field type characters are listed in Table 27.8.

The field width is an optional integer, followed optionally by a period and a precision. The width specifies the minimum number of characters that will be written to the result for this field. For numeric fields, the precision controls the number of decimal places displayed. For string fields, the precision determines the maximum number of characters to be copied from the string. (Thus, the format sequence %10.10s will always contribute exactly ten characters to the result.)

```
printf("%d %04x", 123, 123) → "123_007b"
printf("%08b '%4s'", 123, 123) → "01111011_'_123'"
printf("%1$*2$s %2$d %1$s", "hello", 8) → "____hello_8_hello"
printf("%1$*2$s %2$d", "hello", -8) → "hello_____8"
printf("%+g:% g:%-g", 1.23, 1.23, 1.23) → "+1.23:_.1.23:1.23"
```

---

**srand** srand( *number* ) → *old\_seed*

---

Seeds the pseudorandom number generator to the value of *number.to\_i.abs*. If *number* is omitted or zero, seeds the generator using a combination of the time, the process ID, and a sequence number. (This is also the behavior if Kernel.rand is called without previously calling srand, but without the sequence.) By setting the seed to a known value, scripts that use rand can be made deterministic during testing. The previous seed value is returned. Also see Kernel.rand on page 506.

---

**sub** sub( *pattern*, *replacement* ) → \$\_  
sub( *pattern* ) { *block* } → \$\_  
\_\_\_\_\_

---

Equivalent to \$\_.sub(*args*), except that \$\_ will be updated if substitution occurs.

---

**sub!** sub!( *pattern*, *replacement* ) → \$\_ or nil  
sub!( *pattern* ) { *block* } → \$\_ or nil  
\_\_\_\_\_

---

Equivalent to \$\_.sub!(*args*).

---

**syscall** syscall(*fixnum* < , *args* )\* ) → *int*

---

Calls the operating system function identified by *fixnum*. The arguments must be either String objects or Integer objects that fit within a native long. Up to nine parameters may be passed. The function identified by *fixnum* is system dependent. On some Unix systems, the numbers may be obtained from a header file called syscall.h.

```
syscall 4, 1, "hello\n", 6 # '4' is write(2) on our system
produces:
hello
```

---

**system** system( *command* < , *args* )\* ) → true or false

---

Executes *command* in a subshell, returning true if the command was found and ran

Table 27.7. `sprintf` flag characters

Flag	Applies to	Meaning
<code>_</code> (space) <code>digit\$</code>	<code>bdEefGgiouXx</code> all	Leave a space at the start of positive numbers. Specify the absolute argument number for this field. Absolute and relative argument numbers cannot both be used in a <code>sprintf</code> string.
<code>#</code>	<code>beEfgGoxX</code>	Use an alternative format. For the conversions <code>b</code> , <code>o</code> , <code>X</code> , and <code>x</code> , prefix the result with <code>b</code> , <code>0</code> , <code>0X</code> , <code>0x</code> , respectively. For <code>E</code> , <code>e</code> , <code>f</code> , <code>G</code> , and <code>g</code> , force a decimal point to be added, even if no digits follow. For <code>G</code> and <code>g</code> , do not remove trailing zeros.
<code>+</code>	<code>bdEefGgiouXx</code>	Add a leading plus sign to positive numbers.
<code>-</code>	all	Left-justify the result of this conversion.
<code>0</code> (zero)	<code>bdEefGgiouXx</code>	Pad with zeros, not spaces.
<code>*</code>	all	Use the next argument as the field width. If negative, left-justify the result. If the asterisk is followed by a number and a dollar sign, use the indicated argument as the width.

successfully, `false` otherwise. An error status is available in  `$?` . The arguments are processed in the same way as for `Kernel . exec` on page 500. Raises `SystemCallError` if the *command* couldn't execute (typically `Errno : : ENOENT`).

```
system("echo *")
system("echo", "*")
```

*produces:*

```
config.h main.rb
*
```

---

**test** `test(cmd, file1 < , file2 > ) → obj`

---

Uses the integer *cmd* to perform various tests on *file1* (Table 27.9 on page 512) or on *file1* and *file2* (Table 27.10).

---

**throw** `throw(symbol < , obj > )`

---

Transfers control to the end of the active catch block waiting for *symbol*. Raises `NameError` if there is no catch block for the symbol. The optional second parameter supplies a return value for the catch block, which otherwise defaults to `nil`. For examples, see `Kernel . catch` on page 498.

Table 27.8. `sprintf` field types

Field	Conversion
b	Convert argument as a binary number.
c	Argument is the numeric code for a single character.
d	Convert argument as a decimal number.
E	Equivalent to e, but uses an uppercase <i>E</i> to indicate the exponent.
e	Convert floating point-argument into exponential notation with one digit before the decimal point. The precision determines the number of fractional digits (defaulting to six).
f	Convert floating-point argument as <code>[<u>_-</u>]ddd.ddd</code> , where the precision determines the number of digits after the decimal point.
G	Equivalent to g, but use an uppercase <i>E</i> in exponent form.
g	Convert a floating-point number using exponential form if the exponent is less than <code>-4</code> or greater than or equal to the precision, or in <code>d.ddd</code> form otherwise.
i	Identical to <code>d</code> .
o	Convert argument as an octal number.
p	The value of <code>argument.inspect</code> .
s	Argument is a string to be substituted. If the format sequence contains a precision, at most that many characters will be copied.
u	Treat argument as an unsigned decimal number.
X	Convert argument as a hexadecimal number using uppercase letters. Negative numbers will be displayed with two leading periods (representing an infinite string of leading FFs).
x	Convert argument as a hexadecimal number. Negative numbers will be displayed with two leading periods (representing an infinite string of leading FFs.)

1.8

**trace\_var**

```
trace_var(symbol, cmd) → nil
trace_var(symbol) {|val| block} → nil
```

Controls tracing of assignments to global variables. The parameter *symbol* identifies the variable (as either a string name or a symbol identifier). *cmd* (which may be a string or a Proc object) or the block is executed whenever the variable is assigned, and receives the variable's new value as a parameter. Only explicit assignments are traced. Also see `Kernel.untrace_var`.

```
trace_var :$_, lambda {|v| puts "$_ is now '#{v}'" }
$_ = "hello"
sub(/ello/, "i")
$_ += " Dave"
```

*produces:*

```
$_ is now 'hello'
$_ is now 'hi Dave'
```

Table 27.9. File tests with a single argument

Flag	Description	Returns
?A	Last access time for <i>file1</i>	Time
?b	True if <i>file1</i> is a block device	true or false
?c	True if <i>file1</i> is a character device	true or false
?C	Last change time for <i>file1</i>	Time
?d	True if <i>file1</i> exists and is a directory	true or false
?e	True if <i>file1</i> exists	true or false
?f	True if <i>file1</i> exists and is a regular file	true or false
?g	True if <i>file1</i> has the setgid bit set (false under NT)	true or false
?G	True if <i>file1</i> exists and has a group ownership equal to the caller's group	true or false
?k	True if <i>file1</i> exists and has the sticky bit set	true or false
?l	True if <i>file1</i> exists and is a symbolic link	true or false
?M	Last modification time for <i>file1</i>	Time
?o	True if <i>file1</i> exists and is owned by the caller's effective UID	true or false
?O	True if <i>file1</i> exists and is owned by the caller's real UID	true or false
?p	True if <i>file1</i> exists and is a fifo	true or false
?r	True if <i>file1</i> is readable by the effective UID/GID of the caller	true or false
?R	True if <i>file1</i> is readable by the real UID/GID of the caller	true or false
?s	If <i>file1</i> has nonzero size, return the size, otherwise return nil	Integer or nil
?S	True if <i>file1</i> exists and is a socket	true or false
?u	True if <i>file1</i> has the setuid bit set	true or false
?w	True if <i>file1</i> exists and is writable by the effective UID/ GID	true or false
?W	True if <i>file1</i> exists and is writable by the real UID/GID	true or false
?x	True if <i>file1</i> exists and is executable by the effective UID/GID	true or false
?X	True if <i>file1</i> exists and is executable by the real UID/GID	true or false
?z	True if <i>file1</i> exists and has a zero length	true or false

Table 27.10. File tests with two arguments

Flag	Description
?-	True if <i>file1</i> is a hard link to <i>file2</i>
?=	True if the modification times of <i>file1</i> and <i>file2</i> are equal
?<	True if the modification time of <i>file1</i> is prior to that of <i>file2</i>
?>	True if the modification time of <i>file1</i> is after that of <i>file2</i>

---

**trap** trap( *signal*, *proc* ) → *obj*  
trap( *signal* ) { *block* } → *obj*

---

See the Signal module on page 583.

---

**untrace\_var** untrace\_var( *symbol* ⟨ , *cmd* ⟩ ) → *array* or *nil*

---

Removes tracing for the specified command on the given global variable and returns *nil*. If no command is specified, removes all tracing for that variable and returns an array containing the commands actually removed.

---

**warn** warn *msg*

---

1.8 Writes the given message to STDERR (unless \$VERBOSE is *nil*, perhaps because the `-W0` command-line option was given).

warn "Danger, Will Robinson!"

*produces:*

Danger, Will Robinson!

**Module Marshal**

The marshaling library converts collections of Ruby objects into a byte stream, allowing them to be stored outside the currently active script. This data may subsequently be read and the original objects reconstituted. Marshaling is described starting on page 395. Also see the YAML library on page 737.

Marshaled data has major and minor version numbers stored along with the object information. In normal use, marshaling can load only data written with the same major version number and an equal or lower minor version number. If Ruby’s “verbose” flag is set (normally using `-d`, `-v`, `-w`, or `--verbose`), the major and minor numbers must match exactly. Marshal versioning is independent of Ruby’s version numbers. You can extract the version by reading the first two bytes of marshaled data.

```
str = Marshal.dump("thing")
RUBY_VERSION → "1.8.2"
str[0] → 4
str[1] → 8
```

1.8

Some objects cannot be dumped: if the objects to be dumped include bindings, procedure or method objects, instances of class IO, or singleton objects, or if you try to dump anonymous classes or modules, a `TypeError` will be raised.

If your class has special serialization needs (for example, if you want to serialize in some specific format), or if it contains objects that would otherwise not be serializable, you can implement your own serialization strategy. Prior to Ruby 1.8, you defined the methods `_dump` and `_load`.

1.8

Ruby 1.8 includes a more flexible interface to custom serialization using the instance methods `marshal_dump` and `marshal_load`: If an object to be marshaled responds to `marshal_dump`, that method is called instead of `_dump`. `marshal_dump` can return an object of any class (not just a String). A class that implements `marshal_dump` must also implement `marshal_load`, which is called as an instance method of a newly allocated object and passed the object originally created by `marshal_load`.

The following code uses this new framework to store a `Time` object in the serialized version of an object. When loaded, this object is passed to `marshal_load`, which converts this time to a printable form, storing the result in an instance variable.

```
class TimedDump
 attr_reader :when_dumped
 def marshal_dump
 Time.now
 end
 def marshal_load(when_dumped)
 @when_dumped = when_dumped.strftime("%I:%M%p")
 end
end
```

```
t = TimedDump.new
t.when_dumped → nil

str = Marshal.dump(t)

newt = Marshal.load(str)
newt.when_dumped → "10:38PM"
```

## Module constants

---

**MAJOR\_VERSION** Major part of marshal format version number.  
**MINOR\_VERSION** Minor part of marshal format version number.

## Module methods

---

**dump** dump(*obj* ⟨ , *io* ⟩ , *limit*=-1 ) → *io*

---

Serializes *obj* and all descendent objects. If *io* is specified, the serialized data will be written to it; otherwise the data will be returned as a String. If *limit* is specified, the traversal of subobjects will be limited to that depth. If *limit* is negative, no checking of depth will be performed.

```
class Klass
 def initialize(str)
 @str = str
 end
 def say_hello
 @str
 end
end

o = Klass.new("hello\n")
data = Marshal.dump(o)
obj = Marshal.load(data)
obj.say_hello → "hello\n"
```

**load** load(*from* ⟨ , *proc* ⟩ ) → *obj*

---

Returns the result of converting the serialized data in *from* into a Ruby object (possibly with associated subordinate objects). *from* may be either an instance of IO or an object that responds to `to_str`. If *proc* is specified, it will be passed each object as it is deserialized.

**restore** restore(*from* ⟨ , *proc* ⟩ ) → *obj*

---

A synonym for `Marshal.load`.

**Class** MatchData < Object

All pattern matches set the special variable `$~` to a MatchData containing information about the match. The methods `Regexp#match` and `Regexp#last_match` also return a MatchData object. The object encapsulates all the results of a pattern match, results normally accessed through the special variables `$&`, `$'`, `$``, `$1`, `$2`, and so on. Class Matchdata is also known as MatchingData.

**Instance methods**

---

**[ ]** *match[i] → obj*  
*match[start, length] → array*  
*match[range] → array*

---

Match Reference—MatchData acts as an array, and may be accessed using the normal array indexing techniques. `match[0]` is equivalent to the special variable `$&` and returns the entire matched string. `match[1]`, `match[2]`, and so on, return the values of the matched back references (portions of the pattern between parentheses). See also `MatchData#select` and `MatchData#values_at`.

1.8

```
m = /(.)+(\d+)\d/.match("THX1138.")
m[0] → "HX1138"
m[1, 2] → ["H", "X"]
m[1..3] → ["H", "X", "113"]
m[-3, 2] → ["X", "113"]
```

---

**begin** *match.begin(n) → int*

---

Returns the offset of the start of the *n*th element of the match array in the string.

```
m = /(.)+(\d+)\d/.match("THX1138.")
m.begin(0) → 1
m.begin(2) → 2
```

---

**captures** *match.captures → array*

---

1.8

Returns the array of all the matching groups. Compare to `MatchData#to_a`, which returns both the complete matched string and all the matching groups.

```
m = /(.)+(\d+)\d/.match("THX1138.")
m.captures → ["H", "X", "113", "8"]
```

`captures` is useful when extracting parts of a match in an assignment.

```
f1, f2, f3 = /(.)+(\d+)\d/.match("THX1138.").captures
f1 → "H"
f2 → "X"
f3 → "113"
```



---

**end** *match.end(n) → int*

---

Returns the offset of the character immediately following the end of the *n*th element of the match array in the string.

```
m = /(.)+(\d+)\d/.match("THX1138.")
m.end(0) → 7
m.end(2) → 3
```

---

**length** *match.length → int*

---

Returns the number of elements in the match array.

```
m = /(.)+(\d+)\d/.match("THX1138.")
m.length → 5
m.size → 5
```

---

**offset** *match.offset(n) → array*

---

Returns a two-element array containing the beginning and ending offsets of the *n*th match.

```
m = /(.)+(\d+)\d/.match("THX1138.")
m.offset(0) → [1, 7]
m.offset(4) → [6, 7]
```

---

**post\_match** *match.post\_match → string*

---

Returns the portion of the original string after the current match. Equivalent to the special variable `$'`.

```
m = /(.)+(\d+)\d/.match("THX1138: The Movie")
m.post_match → ": The Movie"
```

---

**pre\_match** *match.pre\_match → string*

---

Returns the portion of the original string before the current match. Equivalent to the special variable `$``.

```
m = /(.)+(\d+)\d/.match("THX1138.")
m.pre_match → "T"
```

---

**select** *match.select { |val| block } → array*

---

1.8 Returns an array containing all elements of *match* for which *block* is true.

```
m = /(.)+(\d+)\d/.match("THX1138: The Movie")
m.to_a → ["HX1138", "H", "X", "113", "8"]
m.select { |v| v =~ /\d\d/ } → ["HX1138", "113"]
```

---

**size** *match.size → int*

---

A synonym for `MatchData#length`.

---

**string** *match.string* → *string*

---

Returns a frozen copy of the string passed in to `match`.

```
m = /(.)+(\d+)/.match("THX1138.")
m.string → "THX1138."
```

---

**to\_a** *match.to\_a* → *array*

---

Returns the array of matches. Unlike `MatchData#captures`, returns the full string matched.

```
m = /(.)+(\d+)/.match("THX1138.")
m.to_a → ["HX1138", "H", "X", "113", "8"]
```

---

**to\_s** *match.to\_s* → *string*

---

Returns the entire matched string.

```
m = /(.)+(\d+)/.match("THX1138.")
m.to_s → "HX1138"
```

---

**values\_at** *match.values\_at( <index>\* )* → *array*

---

1.8 Uses each *index* to access the matching values, returning an array of the corresponding matches.

```
m = /(.)+(\d+)/.match("THX1138: The Movie")
m.to_a → ["HX1138", "H", "X", "113", "8"]
m.values_at(0, 2, -2) → ["HX1138", "X", "113"]
```

**Module Math**

The Math module contains module methods for basic trigonometric and transcendental functions. See class `Float` on page 466 for a list of constants that define Ruby's floating-point accuracy.

**Module constants**

`E` Value of  $e$  (base of natural logarithms)  
`PI` Value of  $\pi$

**Module methods**

<b>acos</b>	<code>Math.acos(x)</code> → <i>float</i>
<u>1.8</u>	Computes the arc cosine of $x$ . Returns $0..π$ .
<b>acosh</b>	<code>Math.acosh(x)</code> → <i>float</i>
<u>1.8</u>	Computes the inverse hyperbolic cosine of $x$ .
<b>asin</b>	<code>Math.asin(x)</code> → <i>float</i>
<u>1.8</u>	Computes the arc sine of $x$ . Returns $0..π$ .
<b>asinh</b>	<code>Math.asinh(x)</code> → <i>float</i>
<u>1.8</u>	Computes the inverse hyperbolic sine of $x$ .
<b>atan</b>	<code>Math.atan(x)</code> → <i>float</i>
<u>1.8</u>	Computes the arc tangent of $x$ . Returns $-\frac{\pi}{2}.. \frac{\pi}{2}$ .
<b>atanh</b>	<code>Math.atanh(x)</code> → <i>float</i>
<u>1.8</u>	Computes the inverse hyperbolic tangent of $x$ .
<b>atan2</b>	<code>Math.atan2(y, x)</code> → <i>float</i>
	Computes the arc tangent given $y$ and $x$ . Returns $-\pi..π$ .
<b>cos</b>	<code>Math.cos(x)</code> → <i>float</i>
	Computes the cosine of $x$ (expressed in radians). Returns $-1..1$ .
<b>cosh</b>	<code>Math.cosh(x)</code> → <i>float</i>
<u>1.8</u>	Computes the hyperbolic cosine of $x$ (expressed in radians).

---

**erf** Math.erf(*x*) → *float*

---

1.8 Returns the error function of *x*.

$$\operatorname{erf}(x) = \frac{2}{\sqrt{\pi}} \int_0^x e^{-t^2} dt$$

---

**erfc** Math.erfc(*x*) → *float*

---

1.8 Returns the complementary error function of *x*.

$$\operatorname{erfc}(x) = 1 - \frac{2}{\sqrt{\pi}} \int_0^x e^{-t^2} dt$$

---

**exp** Math.exp(*x*) → *float*

---

Returns  $e^x$ .

---

**frexp** Math.frexp(*numeric*) → [*fraction*, *exponent*]

---

Returns a two-element array containing the normalized fraction (a Float) and exponent (a Fixnum) of *numeric*.

```
fraction, exponent = Math.frexp(1234) → [0.6025390625, 11]
fraction * 2**exponent → 1234.0
```

---

**hypot** Math.hypot(*x*, *y*) → *float*

---

1.8 Returns  $\sqrt{x^2 + y^2}$ , the hypotenuse of a right-angled triangle with sides *x* and *y*.

```
Math.hypot(3, 4) → 5.0
```

---

**ldexp** Math.ldexp(*float*, *integer*) → *float*

---

Returns the value of  $float \times 2^{integer}$ .

```
fraction, exponent = Math.frexp(1234)
Math.ldexp(fraction, exponent) → 1234.0
```

---

**log** Math.log(*numeric*) → *float*

---

Returns the natural logarithm of *numeric*.

---

**log10** Math.log10(*numeric*) → *float*

---

Returns the base 10 logarithm of *numeric*.

---

**sin** Math.sin(*numeric*) → *float*

---

Computes the sine of *numeric* (expressed in radians). Returns  $-1..1$ .

---

**sinh** Math.sinh( *numeric* ) → *float*

---

1.8 Computes the hyperbolic sine of *numeric* (expressed in radians).

---

**sqrt** Math.sqrt( *numeric* ) → *float*

---

Returns the non-negative square root of *numeric*. Raises `ArgError` if *numeric* is less than zero.

---

**tan** Math.tan( *numeric* ) → *float*

---

Returns the tangent of *numeric* (expressed in radians).

---

**tanh** Math.tanh( *numeric* ) → *float*

---

1.8 Computes the hyperbolic tangent of *numeric* (expressed in radians).

**Class** **Method** < Object

Method objects are created by `Object#method`. They are associated with a particular object (not just with a class). They may be used to invoke the method within the object and as a block associated with an iterator. They may also be unbound from one object (creating an `UnboundMethod`) and bound to another.

```
def square(n)
 n*n
end
meth = self.method(:square)

meth.call(9) → 81
[1, 2, 3].collect(&meth) → [1, 4, 9]
```

**Instance methods**

---

**[ ]** *meth[ < args >\* ] → object*

---

Synonym for `Method.call`.

---

**==** *meth== other → true or false*

---

1.8 Returns true if *meth* is the same method as *other*.

```
def fred()
 puts "Hello"
end

alias bert fred → nil

m1 = method(:fred)
m2 = method(:bert)
m1 == m2 → true
```

---

**arity** *meth.arity → fixnum*

---

Returns an indication of the number of arguments accepted by a method. See Figure 27.2 on the next page.

---

**call** *meth.call( < args >\* ) → object*

---

Invokes the *meth* with the specified arguments, returning the method's return value.

```
m = 12.method("+")
m.call(3) → 15
m.call(20) → 32
```

---

**eq!?** *meth.eq!(other) → true or false*

---

1.8 Returns true if *meth* is the same method as *other*. ▶▶▶

Figure 27.2. Method#arity in action

Method#arity returns a non-negative integer for methods that take a fixed number of arguments. For Ruby methods that take a variable number of arguments, returns  $-n - 1$ , where  $n$  is the number of required arguments. For methods written in C, returns  $-1$  if the call takes a variable number of arguments.

```
class C
 def one; end
 def two(a); end
 def three(*a); end
 def four(a, b); end
 def five(a, b, *c); end
 def six(a, b, *c, &d); end
end
c = C.new
c.method(:one).arity → 0
c.method(:two).arity → 1
c.method(:three).arity → -1
c.method(:four).arity → 2
c.method(:five).arity → -3
c.method(:six).arity → -3

"cat".method(:size).arity → 0
"cat".method(:replace).arity → 1
"cat".method(:squeeze).arity → -1
"cat".method(:count).arity → -1
```

```
def fred()
 puts "Hello"
end

alias bert fred → nil

m1 = method(:fred)
m2 = method(:bert)
m1.eql?(m2) → false
```

---

**to\_proc** *meth.to\_proc* → *prc*

1.8 Returns a Proc object corresponding to this method. Because to\_proc is called by the interpreter when passing block arguments, method objects may be used following an ampersand to pass a block to another method call. See the Thing example at the start of this section.

---

**unbind** *meth.unbind* → *unbound\_method*

1.8 Dissociates *meth* from its current receiver. The resulting UnboundMethod can subsequently be bound to a new object of the same class (see UnboundMethod on page 630).

**Class** **Module** < Object

Subclasses: Class

A `Module` is a collection of methods and constants. The methods in a module may be instance methods or module methods. Instance methods appear as methods in a class when the module is included; module methods do not. Conversely, module methods may be called without creating an encapsulating object, and instance methods may not. See also `Module#module_function` on page 537.

In the descriptions that follow, the parameter *symbol* refers to a symbol, which is either a quoted string or a `Symbol` (such as `:name`).

```
module Mod
 include Math
 CONST = 1
 def meth
 # ...
 end
end
Mod.class → Module
Mod.constants → ["E", "CONST", "PI"]
Mod.instance_methods → ["meth"]
```

**Class methods**

---

**constants** `Module.constants` → *array*

---

Returns an array of the names of all constants defined in the system. This list includes the names of all modules and classes.

```
p Module.constants.sort[1..5]
```

*produces:*

```
["ARGV", "ArgumentError", "Array", "Bignum", "Binding"]
```

---

**nesting** `Module.nesting` → *array*

---

Returns the list of `Modules` nested at the point of call.

```
module M1
 module M2
 $a = Module.nesting
 end
end
$a → [M1::M2, M1]
$a[0].name → "M1::M2"
```



**new**Module.new → *mod*Module.new { |*mod*| *block* } → *mod*1.8

Creates a new anonymous module. If a block is given, it is passed the module object, and the block is evaluated in the context of this module using `module_eval`.

```
Fred = Module.new do
 def meth1
 "hello"
 end
 def meth2
 "bye"
 end
end
a = "my string"
a.extend(Fred) → "my string"
a.meth1 → "hello"
a.meth2 → "bye"
```

**Instance methods**

&lt;, &lt;=, &gt;, &gt;=

*mod relop module* → true or false

Hierarchy Query—One module is considered *greater than* another if it is included in (or is a parent class of) the other module. The other operators are defined accordingly. If there is no relationship between the modules, all operators return false.

```
module Mixin
end

module Parent
 include Mixin
end

module Unrelated
end

Parent > Mixin → false
Parent < Mixin → true
Parent <= Parent → true
Parent < Unrelated → nil
Parent > Unrelated → nil
```

&lt;=&gt;

*mod <=> other\_mod* → -1, 0, +1

Comparison—Returns -1 if *mod* includes *other\_mod*, 0 if *mod* is the same module as *other\_mod*, and +1 if *mod* is included by *other\_mod* or if *mod* has no relationship with *other\_mod*.

===

*mod === obj* → true or false

Case Equality—Returns true if *obj* is an instance of *mod* or one of *mod*'s descendents. Of limited use for modules, but can be used in case statements to test objects by class.

**ancestors***mod.ancestors* → *array*

Returns a list of modules included in *mod* (including *mod* itself).

```
module Mod
 include Math
 include Comparable
end

Mod.ancestors → [Mod, Comparable, Math]
Math.ancestors → [Math]
```

**autoload***mod autoload( name, file\_name )* → *nil*

1.8 Registers *file\_name* to be loaded (using `Kernel.require`) the first time that module *name* (which may be a `String` or a `Symbol`) is accessed in the namespace of *mod*. Note that the autoloaded file is evaluated in the top-level context. In this example, `module_b.rb` contains

```
module A::B # in module_b.rb
 def doit
 puts "In Module A::B"
 end
 module_function :doit
end
```

Other code can then include this module automatically.

```
module A
 autoload(:B, "module_b")
end

A::B.doit # autoloads "module_b"

produces:

In Module A::B
```

**autoload?***mod autoload?( name )* → *file\_name* or *nil*

1.8 Returns the name of the file that will be autoloaded when the string or symbol *name* is referenced in the context of *mod*, or returns `nil` if there is no associated autoload.

```
module A
 autoload(:B, "module_b")
end

A autoload?(:B) → "module_b"
A autoload?(:C) → nil
```

**class\_eval**

*mod.class\_eval( string <, file\_name <, line\_number >> )* → *obj*  
*mod.class\_eval { block }* → *obj*

Synonym for `Module.module_eval`.

---

**class\_variables** *mod.class\_variables* → *array*

---

Returns an array of the names of class variables in *mod* and the ancestors of *mod*.

```
class One
 @@var1 = 1
end
class Two < One
 @@var2 = 2
end
One.class_variables → ["@@var1"]
Two.class_variables → ["@@var2", "@@var1"]
```

---

**clone** *mod.clone* → *other\_mod*

---

Creates a new copy of a module.

```
m = Math.clone → #<Module:0x1c9760>
m.constants → ["E", "PI"]
m == Math → false
```

---

**const\_defined?** *mod.const\_defined?(symbol)* → true or false

---

Returns true if a constant with the given name is defined by *mod*.

```
Math.const_defined? "PI" → true
```

---

**const\_get** *mod.const\_get(symbol)* → *obj*

---

Returns the value of the named constant in *mod*.

```
Math.const_get :PI → 3.14159265358979
```

---

**const\_missing** *const\_missing(symbol)* → *obj*

---

1.8

Invoked when a reference is made to an undefined constant in *mod*. It is passed a symbol for the undefined constant and returns a value to be used for that constant. The following code is very poor style. If a reference is made to an undefined constant, it attempts to load a file whose name is the lowercase version of the constant (thus, class Fred is assumed to be in file fred.rb). If found, it returns the value of the loaded class. It therefore implements a perverse kind of autoload facility.

```
def Object.const_missing(name)
 @looked_for ||= {}
 str_name = name.to_s
 raise "Class not found: #{name}" if @looked_for[str_name]
 @looked_for[str_name] = 1
 file = str_name.downcase
 require file
 klass = const_get(name)
 return klass if klass
 raise "Class not found: #{name}"
end
```

---

**const\_set** *mod.const\_set( symbol, obj ) → obj*

---

Sets the named constant to the given object, returning that object. Creates a new constant if no constant with the given name previously existed.

```
Math.const_set("HIGH_SCHOOL_PI", 22.0/7.0) → 3.14285714285714
Math::HIGH_SCHOOL_PI - Math::PI → 0.00126448926734968
```

---

**constants** *mod.constants → array*

---

Returns an array of the names of the constants accessible in *mod*. This includes the names of constants in any included modules (example at start of section).

---

**include?** *mod.include?( other\_mod ) → true or false*

---

1.8 Returns true if *other\_mod* is included in *mod* or one of *mod*'s ancestors.

```
module A
end

class B
 include A
end

class C < B
end

B.include?(A) → true
C.include?(A) → true
A.include?(A) → false
```

---

**included\_modules** *mod.included\_modules → array*

---

Returns the list of modules included in *mod*.

```
module Mixin
end

module Outer
 include Mixin
end

Mixin.included_modules → []
Outer.included_modules → [Mixin]
```

---

**instance\_method** *mod.instance\_method( symbol ) → unbound\_method*

---

1.8 Returns an UnboundMethod representing the given instance method in *mod*.

```
class Interpreter
 def do_a() print "there, "; end
 def do_d() print "Hello "; end
 def do_e() print "!\n"; end
 def do_v() print "Dave"; end
end
```

```

Dispatcher = {
 ?a => instance_method(:do_a),
 ?d => instance_method(:do_d),
 ?e => instance_method(:do_e),
 ?v => instance_method(:do_v)
}
def interpret(string)
 string.each_byte {|b| Dispatcher[b].bind(self).call }
end
end

interpreter = Interpreter.new
interpreter.interpret('dave')

```

*produces:*

Hello there, Dave!

---

**instance\_methods** *mod.instance\_methods(inc\_super=true) → array*

1.8

Returns an array containing the names of public instance methods in the receiver. For a module, these are the public methods; for a class, they are the instance (not singleton) methods. With no argument, or with an argument that is true, the methods in *mod* and *mod*'s superclasses are returned. When called with a module as a receiver or with a parameter that is false, the instance methods in *mod* are returned. (The parameter defaults to false in versions of Ruby prior to January 2004.)

```

module A
 def method1()
 end
end

class B
 def method2()
 end
end

class C < B
 def method3()
 end
end

A.instance_methods
B.instance_methods(false)
C.instance_methods(false)
C.instance_methods(true).length

```

---

**method\_defined?** *mod.method\_defined?(symbol) → true or false*

Returns true if the named method is defined by *mod* (or its included modules and, if *mod* is a class, its ancestors). Public and protected methods are matched.

```

module A
 def method1() end
end
class B
 def method2() end
end
class C < B
 include A
 def method3() end
end

A.method_defined? :method1 → true
C.method_defined? "method1" → true
C.method_defined? "method2" → true
C.method_defined? "method3" → true
C.method_defined? "method4" → false

```

---

**module\_eval** *mod.class\_eval( string ⟨ , file\_name ⟨ , line\_number ⟩ ⟩ ) → obj*  
*mod.module\_eval { block } → obj*

---

1.8

Evaluates the string or block in the context of *mod*. This can be used to add methods to a class. `module_eval` returns the result of evaluating its argument. The optional *file\_name* and *line\_number* parameters set the text for error messages.

```

class Thing
end
a = %q{def hello() "Hello there!" end}
Thing.module_eval(a)
puts Thing.new.hello()
Thing.module_eval("invalid code", "dummy", 123)

```

*produces:*

```

Hello there!
dummy:123:in `module_eval': undefined local variable
 or method `code' for Thing:Class

```

---

**name** *mod.name → string*

---

Returns the name of the module *mod*.

---

**private\_class\_method** *mod.private\_class\_method( ⟨ symbol ⟩<sup>+</sup> ) → nil*

---

Makes existing class methods private. Often used to hide the default constructor `new`.

```

class SimpleSingleton # Not thread safe
 private_class_method :new
 def SimpleSingleton.create(*args, &block)
 @me = new(*args, &block) if ! @me
 @me
 end
end

```

---

**private\_instance\_methods***mod.private\_instance\_methods(inc\_super=true) → array*

- 1.8 Returns a list of the private instance methods defined in *mod*. If the optional parameter is true, the methods of any ancestors are included. (The parameter defaults to false in versions of Ruby prior to January 2004.)

```

module Mod
 def method1() end
 private :method1
 def method2() end
end
Mod.instance_methods → ["method2"]
Mod.private_instance_methods → ["method1"]

```

---

**private\_method\_defined?** *mod.private\_method\_defined?(symbol) → true or false*

- 1.8 Returns true if the named private method is defined by *mod* (or its included modules and, if *mod* is a class, its ancestors).

```

module A
 def method1() end
end
class B
 private
 def method2() end
end
class C < B
 include A
 def method3() end
end

A.method_defined? :method1 → true
C.private_method_defined? "method1" → false
C.private_method_defined? "method2" → true
C.method_defined? "method2" → false

```

---

**protected\_instance\_methods***mod.protected\_instance\_methods(inc\_super=true) → array*

- 1.8 Returns a list of the protected instance methods defined in *mod*. If the optional parameter is true, the methods of any ancestors are included. (The parameter defaults to false in versions of Ruby prior to January 2004.)

---

**protected\_method\_defined?** *mod.protected\_method\_defined?(symbol) → true or false*

- 1.8 Returns true if the named protected method is defined by *mod* (or its included modules and, if *mod* is a class, its ancestors).

```

module A
 def method1() end
end
class B
 protected
 def method2() end
end
class C < B
 include A
 def method3() end
end

```

```

A.method_defined? :method1 → true
C.protected_method_defined? "method1" → false
C.protected_method_defined? "method2" → true
C.method_defined? "method2" → true

```

---

**public\_class\_method** *mod.public\_class\_method( < symbol >+ ) → nil*

---

Makes a list of existing class methods public.

---

**public\_instance\_methods** *mod.public\_instance\_methods( inc\_super=true ) → array*

---

1.8 Returns a list of the public instance methods defined in *mod*. If the optional parameter is true, the methods of any ancestors are included. (The parameter defaults to false in versions of Ruby prior to January 2004.)

---

**public\_method\_defined?** *mod.public\_method\_defined?( symbol ) → true or false*

---

1.8 Returns true if the named public method is defined by *mod* (or its included modules and, if *mod* is a class, its ancestors).

```

module A
 def method1() end
end
class B
 protected
 def method2() end
end
class C < B
 include A
 def method3() end
end

```

```

A.method_defined? :method1 → true
C.public_method_defined? "method1" → true
C.public_method_defined? "method2" → false
C.method_defined? "method2" → true

```



## Private instance methods

**alias\_method** alias\_method(*new\_id*, *old\_id*) → *mod*

Makes *new\_id* a new copy of the method *old\_id*. This can be used to retain access to methods that are overridden.

```
module Mod
 alias_method :orig_exit, :exit
 def exit(code=0)
 puts "Exiting with code #{code}"
 orig_exit(code)
 end
end
include Mod
exit(99)
```

*produces:*

Exiting with code 99

**append\_features** append\_features(*other\_mod*) → *mod*

When this module is included in another, Ruby calls `append_features` in this module, passing it the receiving module in *other\_mod*. Ruby's default implementation is to add the constants, methods, and module variables of this module to *other\_mod* if this module has not already been added to *other\_mod* or one of its ancestors. Prior to Ruby 1.8, user code often redefined `append_features`, added its own functionality, and then invoked `super` to handle the real include. In Ruby 1.8, you should instead implement the method `Module#include`. See also `Module#include` on page 535.

1.8

**attr** attr(*symbol*, *writable=false*) → nil

Defines a named attribute for this module, where the name is *symbol.id2name*, creating an instance variable (`@name`) and a corresponding access method to read it. If the optional *writable* argument is `true`, also creates a method called `name=` to set the attribute.

```
module Mod
 attr :size, true
end
```

*is equivalent to:*

```
module Mod
 def size
 @size
 end
 def size=(val)
 @size = val
 end
end
```

---

**attr\_accessor** attr\_accessor( < symbol >+ ) → nil

---

Equivalent to calling “attr *symbol*, true” on each *symbol* in turn.

```
module Mod
 attr_accessor(:one, :two)
end
Mod.instance_methods.sort → ["one", "one=", "two", "two="]
```

---

**attr\_reader** attr\_reader( < symbol >+ ) → nil

---

Creates instance variables and corresponding methods that return the value of each instance variable. Equivalent to calling attr :*name* on each name in turn.

---

**attr\_writer** attr\_writer( < symbol >+ ) → nil

---

Creates an accessor method to allow assignment to the attribute *symbol.id2name*.

---

**define\_method** define\_method( symbol, method ) → method  
define\_method( symbol ) { block } → proc

---

1.8

Defines an instance method in the receiver. The *method* parameter can be a Proc or Method object. If a block is specified, it is used as the method body. This block is evaluated using `instance_eval`. This is tricky to demonstrate because `define_method` is private. (This is why we resort to the send hack in this example.)

```
class A
 def fred
 puts "In Fred"
 end
 def create_method(name, &block)
 self.class.send(:define_method, name, &block)
 end
 define_method(:wilma) { puts "Charge it!" }
end
class B < A
 define_method(:barney, instance_method(:fred))
end
b = B.new
b.barney
b.wilma
b.create_method(:betty) { p self }
b.betty
```

*produces:*

```
In Fred
Charge it!
#<B:0x1c9134>
```

---

**extend\_object** extend\_object(*obj*) → *obj*

---

Extends the specified object by adding this module's constants and methods (which are added as singleton methods). This is the callback method used by `Object#extend`.

```
module Picky
 def Picky.extend_object(o)
 if String === o
 puts "Can't add Picky to a String"
 else
 puts "Picky added to #{o.class}"
 super
 end
 end
end
(s = Array.new).extend Picky # Call Object.extend
(s = "quick brown fox").extend Picky
```

*produces:*

```
Picky added to Array
Can't add Picky to a String
```

---

**extended** extended(*other\_mod*)

---

1.8 Callback invoked whenever the receiver is used to extend an object. The object is passed as a parameter. This should be used in preference to `Module#extend_object` if your code wants to perform some action when a module is used to extend an object.

```
module A
 def A.extended(obj)
 puts "#{self} extending '#{obj}'"
 end
end
"cat".extend(A)
```

*produces:*

```
A extending 'cat'
```

---

**include** include( <*other\_mod*><sup>+</sup> ) → *mod*

---

Invokes `Module.append_features` (documented on page 533) on each parameter (in reverse order). Equivalent to the following code.

```
def include(*modules)
 modules.reverse_each do |mod|
 mod.append_features(self)
 mod.included(self)
 end
end
```

---

**included** included(*other\_mod*)

---

1.8 Callback invoked whenever the receiver is included in another module or class. This

should be used in preference to `Module#append_features` if your code wants to perform some action when a module is included in another.

```
module A
 def A.included(mod)
 puts "#{self} included in #{mod}"
 end
end
module Enumerable
 include A
end

produces:
A included in Enumerable
```

---

### **method\_added** method\_added(*symbol*)

---

Invoked as a callback whenever a method is added to the receiver.

```
module Chatty
 def Chatty.method_added(id)
 puts "Adding #{id.id2name}"
 end
 def one() end
end
module Chatty
 def two() end
end

produces:
Adding one
Adding two
```

---

### **method\_removed** method\_removed(*symbol*)

---

1.8 Invoked as a callback whenever a method is removed from the receiver.

```
module Chatty
 def Chatty.method_removed(id)
 puts "Removing #{id.id2name}"
 end
 def one() end
end
module Chatty
 remove_method(:one)
end

produces:
Removing one
```

---

### **method\_undefined** method\_undefined(*symbol*)

---

1.8 Invoked as a callback whenever a method is undefined in the receiver. 

```

module Chatty
 def Chatty.method_undefined(id)
 puts "Undefineding #{id.id2name}"
 end
 def one() end
end
module Chatty
 undef_method(:one)
end

produces:

Undefineding one

```

---

**module\_function** module\_function( < symbol >\* ) → mod

---

Creates module functions for the named methods. These functions may be called with the module as a receiver and are available as instance methods to classes that mix in the module. Module functions are copies of the original and so may be changed independently. The instance-method versions are made private. If used with no arguments, subsequently defined methods become module functions.

```

module Mod
 def one
 "This is one"
 end
 module_function :one
end
class Cls
 include Mod
 def call_one
 one
 end
end
Mod.one → "This is one"
c = Cls.new
c.call_one → "This is one"
module Mod
 def one
 "This is the new one"
 end
end
Mod.one → "This is one"
c.call_one → "This is the new one"

```

---

**private** private( < symbol >\* ) → mod

---

With no arguments, sets the default visibility for subsequently defined methods to private. With arguments, sets the named methods to have private visibility. See “Access Control” starting on page 341.

```

module Mod
 def a() end
 def b() end
 private
 def c() end
 private :a
end
Mod.private_instance_methods → ["c", "a"]

```

---

**protected** protected( *< symbol >\** ) → mod

---

With no arguments, sets the default visibility for subsequently defined methods to protected. With arguments, sets the named methods to have protected visibility. See “Access Control” starting on page 341.

---

**public** public( *< symbol >\** ) → mod

---

With no arguments, sets the default visibility for subsequently defined methods to public. With arguments, sets the named methods to have public visibility. See “Access Control” starting on page 341.

---

**remove\_class\_variable** remove\_class\_variable( *symbol* ) → obj

---

1.8 Removes the definition of the *symbol*, returning that constant’s value.

```

class Dummy
 @@var = 99
 puts @@var
 remove_class_variable(:@@var)
 puts(defined? @@var)
end

```

*produces:*

```

99
nil

```

---

**remove\_const** remove\_const( *symbol* ) → obj

---

Removes the definition of the given constant, returning that constant’s value. Predefined classes and singleton objects (such as *true*) cannot be removed.

---

**remove\_method** remove\_method( *symbol* ) → mod

---

Removes the method identified by *symbol* from the current class. For an example, see `Module.undef_method`.

---

**undef\_method** undef\_method( *< symbol >+* ) → mod

---

Prevents the current class from responding to calls to the named method(s). Contrast this with `remove_method`, which deletes the method from the particular class; Ruby will still search superclasses and mixed-in modules for a possible receiver. ▶▶▶

```
class Parent
 def hello
 puts "In parent"
 end
end
class Child < Parent
 def hello
 puts "In child"
 end
end
c = Child.new
c.hello
class Child
 remove_method :hello # remove from child, still in parent
end
c.hello
class Child
 undef_method :hello # prevent any calls to 'hello'
end
c.hello
produces:
In child
In parent
prog.rb:23: undefined method `hello' for #<Child:0x1c92ec> (NoMethodError)
```

**Class NilClass** < Object

The class of the singleton object nil.

**Instance methods**

---

**&** nil & obj → false

---

And—Returns false. As *obj* is an argument to a method call, it is always evaluated; there is no short-circuit evaluation in this case.

```
nil && puts("logical and")
nil & puts("and")
```

*produces:*

```
and
```

---

**^** nil ^ obj → true or false

---

Exclusive Or—Returns false if *obj* is nil or false, and returns true otherwise.

---

**|** nil | obj → true or false

---

Or—Returns false if *obj* is nil or false, and returns true otherwise.

```
nil | false → false
nil | 99 → true
```

---

**nil?** nil.nil? → true

---

Always returns true.

---

**to\_a** nil.to\_a → []

---

Always returns an empty array.

```
nil.to_a → []
```

---

**to\_f** nil.to\_f → 0.0

---

1.8 Always returns zero.

```
nil.to_f → 0.0
```

---

**to\_i** nil.to\_i → 0

---

Always returns zero.

```
nil.to_i → 0
```

---

**to\_s** nil.to\_s → ""

---

Always returns the empty string.

```
nil.to_s → ""
```

---



**Class** **Numeric** < Object

Subclasses: Float, Integer

Numeric is the fundamental base type for the abstract class Integer and the concrete number classes Float, Fixnum, and Bignum. Many methods in Numeric are overridden in child classes, and Numeric takes some liberties by calling methods in these child classes. A complete list of the methods defined in all five classes is shown in Table 27.11 on page 543.

**Mixes in****Comparable:**

<, <=, ==, >=, >, between?

**Instance methods**

---

**+**@ *num* → *numeric*

---

Unary Plus—Returns the receiver's value.

---

**-**@ *num* → *numeric*

---

Unary Minus—Returns the receiver's value, negated.

---

**<=>** *num* <=> *other* → 0 or nil

---

Returns zero if *num* equals *other*, and returns nil otherwise.

---

**abs** *num.abs* → *numeric*

---

Returns the absolute value of *num*.

```
12.abs → 12
(-34.56).abs → 34.56
-34.56.abs → 34.56
```

---

**ceil** *num.ceil* → *int*

---

Returns the smallest Integer greater than or equal to *num*. Class Numeric achieves this by converting itself to a Float and then invoking Float#ceil.

```
1.ceil → 1
1.2.ceil → 2
(-1.2).ceil → -1
(-1.0).ceil → -1
```

---

**coerce** *num.coerce( numeric )* → *array*

---

coerce is both an instance method of Numeric and part of a type conversion protocol. When a number is asked to perform an operation and it is passed a parameter of a class different to its own, it must first coerce both itself and that parameter into a common

class so that the operation makes sense. For example, in the expression  $1 + 2.5$ , the Fixnum 1 must be converted to a Float to make it compatible with 2.5. This conversion is performed by `coerce`. For all numeric objects, `coerce` is straightforward: if *numeric* is the same type as *num*, returns an array containing *numeric* and *num*. Otherwise, returns an array with both *numeric* and *num* represented as Float objects.

```
1.coerce(2.5) → [2.5, 1.0]
1.2.coerce(3) → [3.0, 1.2]
1.coerce(2) → [2, 1]
```

If a numeric object is asked to operate on a non-numeric, it tries to invoke `coerce` on that other object. For example, if you write

```
1 + "2"
```

Ruby will effectively execute the code as

```
n1, n2 = "2".coerce(1)
n2 + n1
```

In the more general case, this won't work, as most non-numeric objects don't define a `coerce` method. However, you can use this (if you feel so inclined) to implement part of Perl's automatic conversion of strings to numbers in expressions.

```
class String
 def coerce(other)
 case other
 when Integer
 begin
 return other, Integer(self)
 rescue
 return Float(other), Float(self)
 end
 when Float
 return other, Float(self)
 else super
 end
 end
end
```

```
1 + "2" → 3
1 - "2.3" → -1.3
1.2 + "2.3" → 3.5
1.5 - "2" → -0.5
```

`coerce` is discussed further on page 358.

---

## div

*num.div(numeric) → int*

### 1.8

Uses `/` to perform division, and then converts the result to an integer. Numeric does not define the `/` operator; this is left to subclasses.

Table 27.11: Methods defined in class `Numeric` and its subclasses. A ✓ means that the method is defined in the corresponding class.

	Numeric	Integer	Fixnum	Bignum	Float
%	-	-	✓	✓	✓
&	-	-	✓	✓	-
*	-	-	✓	✓	✓
**	-	-	✓	✓	✓
+	-	-	✓	✓	✓
+@	✓	-	-	-	-
-	-	-	✓	✓	✓
-@	✓	-	✓	✓	✓
/	-	-	✓	✓	✓
<	-	-	✓	-	✓
<<	-	-	✓	✓	-
<=	-	-	✓	-	✓
<=>	✓	-	✓	✓	✓
==	-	-	✓	✓	✓
>	-	-	✓	-	✓
>=	-	-	✓	-	✓
>>	-	-	✓	✓	-
[]	-	-	✓	✓	-
^	-	-	✓	✓	-
abs	✓	-	✓	✓	✓
ceil	✓	✓	-	-	✓
chr	-	✓	-	-	✓
coerce	✓	-	-	✓	✓
div	✓	-	✓	✓	-
divmod	✓	-	✓	✓	✓
downto	-	✓	-	-	-
eq!?	✓	-	-	✓	✓
finite?	-	-	-	-	✓
floor	✓	✓	-	-	✓
hash	-	-	-	✓	✓
id2name	-	-	✓	-	-
infinite?	-	-	-	-	✓
integer?	✓	✓	-	-	-
modulo	✓	-	✓	✓	✓
nan?	-	-	-	-	✓
next	-	✓	-	-	-
nonzero?	✓	-	-	-	-
quo	✓	-	✓	✓	-
remainder	✓	-	-	✓	-
round	✓	✓	-	-	✓
size	-	-	✓	✓	-
step	✓	-	-	-	-
succ	-	✓	-	-	-
times	-	✓	-	-	-
to_f	-	-	✓	✓	✓
to_i	-	✓	-	-	✓
to_int	✓	✓	-	-	✓
to_s	-	-	✓	✓	✓
to_sym	-	-	✓	-	-
truncate	✓	✓	-	-	✓
upto	-	✓	-	-	-
zero?	✓	-	✓	-	✓
	-	-	✓	✓	-
~	-	-	✓	✓	-

Table 27.12. Difference between modulo and remainder. The modulo operator (“%”) always has the sign of the divisor whereas remainder has the sign of the dividend.

a	b	a.divmod(b)	a / b	a.modulo(b)	a.remainder(b)
13	4	3, 1	3	1	1
13	-4	-4, -3	-4	-3	1
-13	4	-4, 3	-4	3	-1
-13	-4	3, -1	3	-1	-1
11.5	4	2.0, 3.5	2.875	3.5	3.5
11.5	-4	-3.0, -0.5	-2.875	-0.5	3.5
-11.5	4	-3.0, 0.5	-2.875	0.5	-3.5
-11.5	-4	2.0, -3.5	2.875	-3.5	-3.5

**divmod** *num.divmod( numeric ) → array*

Returns an array containing the quotient and modulus obtained by dividing *num* by *numeric*. If  $q, r = x.divmod(y)$ ,  $q = floor(float(x)/float(y))$  and  $x = q \times y + r$ . The quotient is rounded toward  $-\infty$ . See Table 27.12 for examples.

**eql?** *num.eql?( numeric ) → true or false*

Returns true if *num* and *numeric* are the same type and have equal values.

```
1 == 1.0 → true
1.eql?(1.0) → false
(1.0).eql?(1.0) → true
```

**floor** *num.floor → int*

Returns the largest integer less than or equal to *num*. Numeric implements this by converting *int* to a Float and invoking Float#floor.

```
1.floor → 1
(-1).floor → -1
```

**integer?** *num.integer? → true or false*

Returns true if *num* is an Integer (including Fixnum and Bignum).

**modulo** *num.modulo( numeric ) → numeric*

Equivalent to *num.divmod(numeric)[1]*.

**nonzero?** *num.nonzero? → num or nil*

Returns *num* if *num* is not zero, and returns nil otherwise. This behavior is useful when chaining comparisons.

```
a = %w(z Bb bB bb BB a aA Aa AA A)
b = a.sort {|a,b| (a.downcase <=> b.downcase).nonzero? || a <=> b }
b → ["A", "a", "AA", "Aa", "aA", "BB", "Bb", "bb", "bb", "z"]
```

---

**quo** *num.quo( numeric ) → numeric*

---

1.8 Equivalent to `Numeric#/,` but overridden in subclasses. The intent of `quo` is to return the most accurate result of division (in context). Thus `1.quo(2)` will equal `0.5`, and `1/2` equals `0`.

---

**remainder** *num.remainder( numeric ) → numeric*

---

If *num* and *numeric* have different signs, returns `mod−numeric`; otherwise, returns `mod`. In both cases `mod` is the value `num.modulo(numeric)`. The differences between `remainder` and `modulo (%)` are shown in Table 27.12 on the preceding page.

---

**round** *num.round → int*

---

Rounds *num* to the nearest integer. `Numeric` implements this by converting *int* to a `Float` and invoking `Float#round`.

---

**step** *num.step( end\_num, step ) {|i| block } → num*

---

1.8 Invokes *block* with the sequence of numbers starting at *num*, incremented by *step* on each call. The loop finishes when the value to be passed to the block is greater than *end\_num* (if *step* is positive) or less than *end\_num* (if *step* is negative). If all the arguments are integers, the loop operates using an integer counter. If any of the arguments are floating-point numbers, all are converted to floats, and the loop is executed  $\lfloor n + n * \epsilon \rfloor + 1$  times, where  $n = (end\_num - num) / step$ . Otherwise, the loop starts at *num*, uses either the `<` or `>` operator to compare the counter against *end\_num*, and increments itself using the `+` operator.

```
1.step(10, 2) {|i| print i, " " }
Math::E.step(Math::PI, 0.2) {|f| print f, " " }
```

*produces:*

```
1 3 5 7 9
2.71828182845905 2.91828182845905 3.11828182845905
```

---

**to\_int** *num.to\_int → int*

---

Invokes the child class's `to_i` method to convert *num* to an integer.

---

**truncate** *num.truncate → int*

---

Returns *num* truncated to an integer. `Numeric` implements this by converting its value to a float and invoking `Float#truncate`.

---

**zero?** *num.zero? → true or false*

---

Returns true if *num* has a zero value.

## Class **Object**

Subclasses: Array, Binding, Continuation, Data (used internally by the interpreter), Dir, Exception, FalseClass, File::Stat, Hash, IO, MatchData, Method, Module, NilClass, Numeric, Proc, Process::Status, Range, Regexp, String, Struct, Symbol, Thread, ThreadGroup, Time, TrueClass, UnboundMethod

Object is the parent class of all classes in Ruby. Its methods are therefore available to all objects unless explicitly overridden.

Object mixes in the Kernel module, making the built-in kernel functions globally accessible. Although the instance methods of Object are defined by the Kernel module, we have chosen to document them here for clarity.

In the descriptions that follow, the parameter *symbol* refers to a symbol, which is either a quoted string or a Symbol (such as :name).

### Instance methods

---

**==** *obj == other\_obj* → true or false

---

Equality—At the Object level, == returns true only if *obj* and *other\_obj* are the same object. Typically, this method is overridden in descendent classes to provide class-specific meaning.

---

**===** *obj === other\_obj* → true or false

---

Case Equality—A synonym for Object#===, but typically overridden by descendents to provide meaningful semantics in case statements.

---

**==~** *obj ==~ other\_obj* → false

---

Pattern Match—Overridden by descendents (notably Regexp and String) to provide meaningful pattern-match semantics.

---

**\_\_id\_\_** *obj.\_\_id\_\_* → fixnum

---

Synonym for Object#object\_id.

---

**\_\_send\_\_** *obj.\_\_send\_\_(symbol < , args >+ < , &block > )* → other\_obj

---

Synonym for Object#send.

---

**class** *obj.class* → klass

---

Returns the class of *obj*, now preferred over Object#type, as an object's type in Ruby is only loosely tied to that object's class. This method must always be called with an explicit receiver, as class is also a reserved word in Ruby.

```
1.class → Fixnum
self.class → Object
```

---

**clone** *obj.clone* → *other\_obj*

---

Produces a shallow copy of *obj*—the instance variables of *obj* are copied, but not the objects they reference. Copies the frozen and tainted state of *obj*. See also the discussion under `Object#dup`.

```
class Klass
 attr_accessor :str
end
s1 = Klass.new → #<Klass:0x1c9170>
s1.str = "Hello" → "Hello"
s2 = s1.clone → #<Klass:0x1c90d0 @str="Hello">
s2.str[1,4] = "i" → "i"
s1.inspect → "#<Klass:0x1c9170 @str=\"Hi\">"
s2.inspect → "#<Klass:0x1c90d0 @str=\"Hi\">"
```

---

**display** *obj.display(port=\$>)* → nil

---

Prints *obj* on the given port (default \$>). Equivalent to

```
def display(port=$>)
 port.write self
end
```

For example:

```
1.display
"cat".display
[4, 5, 6].display
puts
```

*produces:*

```
1cat456
```

---

**dup** *obj.dup* → *other\_obj*

---

Produces a shallow copy of *obj*—the instance variables of *obj* are copied, but not the objects they reference. `dup` copies the tainted state of *obj*. See also the discussion under `Object#clone`. In general, `clone` and `dup` may have different semantics in descendent classes. While `clone` is used to duplicate an object, including its internal state, `dup` typically uses the class of the descendent object to create the new instance.

---

**eql?** *obj.eql?(other\_obj)* → true or false

---

Returns true if *obj* and *other\_obj* have the same value. Used by Hash to test members for equality. For objects of class Object, `eql?` is synonymous with `==`. Subclasses normally continue this tradition, but there are exceptions. Numeric types, for example, perform type conversion across `==`, but not across `eql?`, so

```
1 == 1.0 → true
1.eql? 1.0 → false
```

---

**equal?** *obj.equal?( other\_obj ) → true or false*

---

Returns true if *obj* and *other\_obj* have the same object ID. This method should not be overridden by subclasses.

```
a = ['cat', 'dog']
b = ['cat', 'dog']
a == b → true
a.id == b.id → false
a.eql?(b) → true
a.equal?(b) → false
```

---

**extend** *obj.extend( < mod >+ ) → obj*

---

Adds to *obj* the instance methods from each module given as a parameter. See also `Module#extend_object`.

```
module Mod
 def hello
 "Hello from Mod.\n"
 end
end

class Klass
 def hello
 "Hello from Klass.\n"
 end
end

k = Klass.new
k.hello → "Hello from Klass.\n"
k.extend(Mod) → #<Klass:0x1c9300>
k.hello → "Hello from Mod.\n"
```

Writing `obj.extend(Mod)` is basically the same as the following.

```
class <<obj
 include Mod
end
```

---

**freeze** *obj.freeze → obj*

---

Prevents further modifications to *obj*. A `TypeError` will be raised if modification is attempted. You cannot unfreeze a frozen object. See also `Object#frozen?`.

```
a = ["a", "b", "c"]
a.freeze
a << "z"
```

*produces:*

```
prog.rb:3:in `<<': can't modify frozen array (TypeError)
from prog.rb:3
```



---

**frozen?** *obj.frozen?* → true or false

---

Returns the freeze status of *obj*.

```
a = ["a", "b", "c"]
a.freeze → ["a", "b", "c"]
a.frozen? → true
```

---

**hash** *obj.hash* → *fixnum*

---

Generates a Fixnum hash value for this object. This function must have the property that *a.eql?(b)* implies *a.hash == b.hash*. The hash value is used by class Hash. Any hash value that exceeds the capacity of a Fixnum will be truncated before being used.

---

**id** *obj.id* → *fixnum*

---

1.8 Soon-to-be-deprecated version of `Object#object_id`.

---

**initialize\_copy** *obj.initialize\_copy(other)* → *other\_obj* or *obj*

---

1.8 Part of the protocol used by `Object#dup` and `Object#clone`, `initialize_copy` is invoked as a callback which should copy across any state information that `dup` and `clone` cannot copy themselves. Typically this is useful only when writing C extensions. Think of `initialize_copy` as a kind of copy constructor.

---

**inspect** *obj.inspect* → *string*

---

Returns a string containing a human-readable representation of *obj*. If not overridden, uses the `to_s` method to generate the string.

```
[1, 2, 3..4, 'five'].inspect → "[1, 2, 3..4, \"five\"]"
Time.new.inspect → "Thu Aug 26 22:37:49 CDT 2004"
```

---

**instance\_eval** *obj.instance\_eval(string <, file <, line >>)* → *other\_obj*  
*obj.instance\_eval { block }* → *other\_obj*

---

Evaluates a string containing Ruby source code, or the given block, within the context of the receiver (*obj*). To set the context, the variable `self` is set to *obj* while the code is executing, giving the code access to *obj*'s instance variables. In the version of `instance_eval` that takes a String, the optional second and third parameters supply a filename and starting line number that are used when reporting compilation errors.

```
class Klass
 def initialize
 @secret = 99
 end
end
k = Klass.new
k.instance_eval { @secret } → 99
```

---

**instance\_of?** *obj.instance\_of?( klass )* → true or false

---

Returns true if *obj* is an instance of the given class. See also `Object#kind_of?`.

---

**instance\_variable\_get** *obj.instance\_variable\_get( symbol )* → *other\_obj*

---

1.8 Returns the value of the given instance variable (or throws a `NameError` exception). The `@` part of the variable name should be included for regular instance variables.

```
class Fred
 def initialize(p1, p2)
 @a, @b = p1, p2
 end
end
fred = Fred.new('cat', 99)
fred.instance_variable_get(:@a) → "cat"
fred.instance_variable_get("@b") → 99
```

---

**instance\_variable\_set** *obj.instance\_variable\_set( symbol, other\_obj )* → *other\_obj*

---

1.8 Sets the instance variable names by *symbol* to *other\_obj*, thereby frustrating the efforts of the class's author to attempt to provide proper encapsulation.

```
class Fred
 def initialize(p1, p2)
 @a, @b = p1, p2
 end
end
fred = Fred.new('cat', 99)
fred.instance_variable_set(:@a, 'dog') → "dog"
fred.inspect → "#<Fred:0x1c94e0 @b=99,
 @a=\"dog\">"
```

---

**instance\_variables** *obj.instance\_variables* → *array*

---

Returns an array of instance variable names for the receiver. Note that simply defining an accessor does not create the corresponding instance variable.

```
class Fred
 attr_accessor :a1
 def initialize
 @iv = 3
 end
end
Fred.new.instance_variables → ["@iv"]
```

---

**is\_a?** *obj.is\_a?( klass )* → true or false

---

Synonym for `Object#kind_of?`.

---

**kind\_of?** *obj.kind\_of?( class )* → true or false

---

Returns true if *klass* is the class of *obj*, or if *klass* is one of the superclasses of *obj* or modules included in *obj*.

```

module M; end
class A
 include M
end
class B < A; end
class C < B; end
b = B.new
b.instance_of? A → false
b.instance_of? B → true
b.instance_of? C → false
b.instance_of? M → false
b.kind_of? A → true
b.kind_of? B → true
b.kind_of? C → false
b.kind_of? M → true

```

---

**method** *obj.method( symbol )* → meth

---

Looks up the named method in *obj*, returning a Method object (or raising NameError). The Method object acts as a closure in *obj*'s object instance, so instance variables and the value of self remain available.

```

class Demo
 def initialize(n)
 @iv = n
 end
 def hello()
 "Hello, @iv = #{@iv}"
 end
end

k = Demo.new(99)
m = k.method(:hello)
m.call → "Hello, @iv = 99"

l = Demo.new('Fred')
m = l.method("hello")
m.call → "Hello, @iv = Fred"

```

---

**method\_missing** *obj.method\_missing( symbol < , \*args > )* → other\_obj

---

Invoked by Ruby when *obj* is sent a message it cannot handle. *symbol* is the symbol for the method called, and *args* are any arguments that were passed to it. The example below creates a class Roman, which responds to methods with names consisting of roman numerals, returning the corresponding integer values. A more typical use of `method_missing` is to implement proxies, delegators, and forwarders.

```

class Roman
 def roman_to_int(str)
 # ...
 end
 def method_missing(method_id)
 str = method_id.id2name
 roman_to_int(str)
 end
end

r = Roman.new
r.iv → 4
r.xxiii → 23
r.mm → 2000

```

---

**methods** *obj.methods( regular=true ) → array*

1.8 If *regular* is true, returns a list of the names of methods publicly accessible in *obj* and *obj*'s ancestors. Otherwise return a list of *obj*'s singleton methods.

```

class Klass
 def my_method()
 end
end

k = Klass.new
def k.single
 end

k.methods[0..9] → ["dup", "hash", "single", "private_methods",
 "nil?", "tainted?", "class", "my_method",
 "singleton_methods", "=~"]

k.methods.length → 42
k.methods(false) → ["single"]

```

---

**nil?** *obj.nil? → true or false*

All objects except nil return false.

---

**object\_id** *obj.object\_id → fixnum*

1.8 Returns an integer identifier for *obj*. The same number will be returned on all calls to *object\_id* for a given object, and no two active objects will share an ID. *Object#object\_id* is a different concept from the *:name* notation, which returns the symbol ID of *name*. Replaces the deprecated *Object#id*.

---

**private\_methods** *obj.private\_methods → array*

Returns a list of private methods accessible within *obj*. This will include the private methods in *obj*'s ancestors, along with any mixed-in module functions.

---

**protected\_methods** *obj.protected\_methods → array*

Returns the list of protected methods accessible to *obj*.

---

**public\_methods** *obj.public\_methods* → *array*

---

Synonym for `Object#methods`.

---

**respond\_to?** *obj.respond\_to?(symbol, include\_priv=false)* → *true* or *false*

---

Returns `true` if *obj* responds to the given method. Private methods are included in the search only if the optional second parameter evaluates to `true`.

---

**send** *obj.send(symbol <, args>\* <, &block>)* → *other\_obj*

---

Invokes the method identified by *symbol*, passing it any arguments and block. You can use `__send__` if the name `send` clashes with an existing method in *obj*.

```
class Klass
 def hello(*args)
 "Hello " + args.join(' ')
 end
end
k = Klass.new
k.send :hello, "gentle", "readers" → "Hello gentle readers"
```

---

**singleton\_methods** *obj.singleton\_methods(all=true)* → *array*

---

Returns an array of the names of singleton methods for *obj*. If the optional *all* parameter is true, the list will include methods in modules included in *obj*. (The parameter defaults to `false` in versions of Ruby prior to January 2004.)

1.8

```
module Other
 def three() end
end

class Single
 def Single.four() end
end

a = Single.new

def a.one() end

class << a
 include Other
 def two() end
end

Single.singleton_methods → ["four"]
a.singleton_methods(false) → ["two", "one"]
a.singleton_methods(true) → ["two", "one", "three"]
a.singleton_methods → ["two", "one", "three"]
```

---

**taint** *obj.taint* → *obj*

---

Marks *obj* as tainted. If the \$SAFE level is greater than zero, some objects will be tainted on creation. See Chapter 25, which begins on page 379.

---

**tainted?** *obj.tainted?* → true or false

---

Returns true if the object is tainted.

```
a = "cat"
a.tainted? → false
a.taint → "cat"
a.tainted? → true
a.untaint → "cat"
a.tainted? → false
```

---

**to\_a** *obj.to\_a* → array

---

1.8

Returns an array representation of *obj*. For objects of class `Object` and others that don't explicitly override the method, the return value is an array containing `self`. As of Ruby 1.9 `to_a` will no longer be implemented by class `Object`—it is up to individual subclasses to provide their own implementations.

```
self.to_a → -:1: warning: default `to_a' will be
 obsolete\n[main]
"hello".to_a → ["hello"]
Time.new.to_a → [50, 37, 22, 26, 8, 2004, 4, 239, true, "CDT"]
```

---

**to\_s** *obj.to\_s* → string

---

Returns a string representing *obj*. The default `to_s` prints the object's class and an encoding of the object ID. As a special case, the top-level object that is the initial execution context of Ruby programs returns "main."

---

**type** *obj.type* → class

---

1.8

Deprecated synonym for `Object#class`.

---

**untaint** *obj.untaint* → *obj*

---

Removes the taint from *obj*.

## Private instance methods

---

**initialize** *initialize*( < arg >+ )

---

Called as the third and final step in object construction, `initialize` is responsible for setting up the initial state of the new object. You use the `initialize` method the same way you'd use constructors in other languages. If you subclass classes other than `Object`, you will probably want to call `super` to invoke the parent's initializer.

```

class A
 def initialize(p1)
 puts "Initializing A: p1 = #{p1}"
 @var1 = p1
 end
end
class B < A
 attr_reader :var1, :var2
 def initialize(p1, p2)
 super(p1)
 puts "Initializing B: p2 = #{p2}"
 @var2 = p2
 end
end
b = B.new("cat", "dog")
puts b.inspect

produces:

Initializing A: p1 = cat
Initializing B: p2 = dog
#<B:0x1c9224 @var2="dog", @var1="cat">

```

---

**remove\_instance\_variable** remove\_instance\_variable(*symbol*) → *other\_obj*

1.8 Removes the named instance variable from *obj*, returning that variable's value.

```

class Dummy
 attr_reader :var
 def initialize
 @var = 99
 end
 def remove
 remove_instance_variable(:@var)
 end
end
d = Dummy.new
d.var → 99
d.remove → 99
d.var → nil

```

---

**singleton\_method\_added** singleton\_method\_added(*symbol*)

1.8 Invoked as a callback whenever a singleton method is added to the receiver.

```

module Chatty
 def Chatty.singleton_method_added(id)
 puts "Adding #{id.id2name} to #{self.name}"
 end
 def self.one() end
 def two() end
end
def Chatty.three() end

```

```

obj = "cat"
def obj.singleton_method_added(id)
 puts "Adding #{id.id2name} to #{self}"
end
def obj.speak
 puts "meow"
end

```

*produces:*

```

Adding singleton_method_added to Chatty
Adding one to Chatty
Adding three to Chatty
Adding singleton_method_added to cat
Adding speak to cat

```

---

### **singleton\_method\_removed** singleton\_method\_removed(*symbol*)

---

1.8 Invoked as a callback whenever a singleton method is removed from the receiver.

```

module Chatty
 def Chatty.singleton_method_removed(id)
 puts "Removing #{id.id2name}"
 end
 def self.one() end
 def two() end
 def Chatty.three() end
 class <<self
 remove_method :three
 remove_method :one
 end
end

```

*produces:*

```

Removing three
Removing one

```

---

### **singleton\_method\_undefined** singleton\_method\_undefined(*symbol*)

---

1.8 Invoked as a callback whenever a singleton method is undefined in the receiver.

```

module Chatty
 def Chatty.singleton_method_undefined(id)
 puts "Undefined #{id.id2name}"
 end
 def Chatty.one() end
 class << self
 undef_method(:one)
 end
end

```

*produces:*

```

Undefined one

```



**Module**

# ObjectSpace

The ObjectSpace module contains a number of routines that interact with the garbage collection facility and allow you to traverse all living objects with an iterator.

ObjectSpace also provides support for object finalizers. These are procs that will be called when a specific object is about to be destroyed by garbage collection.

```
include ObjectSpace
a, b, c = "A", "B", "C"
puts "a's id is #{a.object_id}"
puts "b's id is #{b.object_id}"
puts "c's id is #{c.object_id}"
define_finalizer(a, lambda {|id| puts "Finalizer one on #{id}" })
define_finalizer(b, lambda {|id| puts "Finalizer two on #{id}" })
define_finalizer(c, lambda {|id| puts "Finalizer three on #{id}" })
```

*produces:*

```
a's id is 936150
b's id is 936140
c's id is 936130
Finalizer three on 936130
Finalizer two on 936140
Finalizer one on 936150
```

## Module methods

---

**`_id2ref`** ObjectSpace.\_id2ref(*object\_id*) → *obj*

---

Converts an object ID to a reference to the object. May not be called on an object ID passed as a parameter to a finalizer.

```
s = "I am a string" → "I am a string"
oid = s.object_id → 936550
r = ObjectSpace._id2ref(oid) → "I am a string"
r → "I am a string"
r.equal?(s) → true
```

---

**`define_finalizer`** ObjectSpace.define\_finalizer(*obj*, *a\_proc*=proc())

---

Adds *a\_proc* as a finalizer, called when *obj* is about to be destroyed.

---

**`each_object`** ObjectSpace.each\_object( < *class\_or\_mod* > ) {|*obj*| *block* } → *fixnum*

---

Calls the block once for each living, nonimmediate object in this Ruby process. If *class\_or\_mod* is specified, calls the block for only those classes or modules that match (or are a subclass of) *class\_or\_mod*. Returns the number of objects found. Immediate objects (Fixnums, Symbols true, false, and nil) are never returned. In the example below, `each_object` returns both the numbers we defined and several constants defined in the Math module.

```

a = 102.7
b = 95 # Fixnum: won't be returned
c = 12345678987654321
count = ObjectSpace.each_object(Numeric) {|x| p x }
puts "Total count: #{count}"

```

*produces:*

```

12345678987654321
102.7
2.71828182845905
3.14159265358979
2.22044604925031e-16
1.79769313486232e+308
2.2250738585072e-308
Total count: 7

```

---

**garbage\_collect** ObjectSpace.garbage\_collect → nil

---

Initiates garbage collection (see module GC on page 470).

---

**undefine\_finalizer** ObjectSpace.undefine\_finalizer(*obj*)

---

Removes all finalizers for *obj*.

**Class Proc** < Object

Proc objects are blocks of code that have been bound to a set of local variables. Once bound, the code may be called in different contexts and still access those variables.

```
def gen_times(factor)
 return Proc.new {|n| n*factor }
end

times3 = gen_times(3)
times5 = gen_times(5)

times3.call(12) → 36
times5.call(5) → 25
times3.call(times5.call(4)) → 60
```

**Class methods**

---

**new** *Proc.new { block } → a\_proc*  
*Proc.new → a\_proc*

---

Creates a new Proc object, bound to the current context. Proc.new may be called without a block only within a method with an attached block, in which case that block is converted to the Proc object.

```
def proc_from
 Proc.new
end
proc = proc_from { "hello" }
proc.call → "hello"
```

**Instance methods**

---

**[]** *prc[ <params>\* ] → obj*

---

Synonym for Proc.call.

---

**==** *prc== other → true or false*

---

1.8 Returns true if *prc* is the same as *other*.

---

**arity** *prc.arity → integer*

---

1.8 Returns the number of arguments required by the block. If the block is declared to take no arguments, returns 0. If the block is known to take exactly *n* arguments, returns *n*. If the block has optional arguments, return  $-(n+1)$ , where *n* is the number of mandatory arguments. A proc with no argument declarations also returns  $-1$ , as it can accept (and ignore) an arbitrary number of parameters.

```

Proc.new {}.arity → -1
Proc.new {||}.arity → 0
Proc.new {|a|}.arity → 1
Proc.new {|a,b|}.arity → 2
Proc.new {|a,b,c|}.arity → 3
Proc.new {|*a|}.arity → -1
Proc.new {|a,*b|}.arity → -2

```

1.8 In Ruby 1.9, `arity` is defined as the number of parameters that would not be ignored. In 1.8, `Proc.new{}.arity` returns -1, and in 1.9 it returns 0.

---

**binding** *proc.binding* → *binding*

1.8 Returns the binding associated with *proc*. Note that `Kernel#eval` accepts either a `Proc` or a `Binding` object as its second parameter.

```

def fred(param)
 lambda {}
end

b = fred(99)
eval("param", b.binding) → 99
eval("param", b) → 99

```

---

**call** *proc.call( <params>\* )* → *obj*

Invokes the block, setting the block's parameters to the values in *params* using something close to method-calling semantics. Returns the value of the last expression evaluated in the block.

```

a_proc = Proc.new {|a, *b| b.collect {|i| i*a }}
a_proc.call(9, 1, 2, 3) → [9, 18, 27]
a_proc[9, 1, 2, 3] → [9, 18, 27]

```

1.8 If the block being called explicitly accepts a single parameter, `call` issues a warning unless it has been given exactly one parameter. Otherwise it happily accepts what it is given, ignoring surplus passed parameters and setting unset block parameters to `nil`.

```

a_proc = Proc.new {|a| a}
a_proc.call(1,2,3)

```

*produces:*

```

prog.rb:1: warning: multiple values for a block parameter (3 for 1)
from prog.rb:2

```

If you want a block to receive an arbitrary number of arguments, define it to accept `*args`.

```

a_proc = Proc.new {|*a| a}
a_proc.call(1,2,3) → [1, 2, 3]

```

Blocks created using `Kernel.lambda` check that they are called with exactly the right number of parameters. ▶▶▶

```

p_proc = Proc.new {|a,b| puts "Sum is: #{a + b}" }
p_proc.call(1,2,3)
p_proc = lambda {|a,b| puts "Sum is: #{a + b}" }
p_proc.call(1,2,3)

produces:

Sum is: 3
prog.rb:3: wrong number of arguments (3 for 2) (ArgumentError)
from prog.rb:3:in `call'
from prog.rb:4

```

---

**to\_proc** *proc.to\_proc* → *proc*

---

1.8 Part of the protocol for converting objects to Proc objects. Instances of class Proc simply return themselves.

---

**to\_s** *proc.to\_s* → *string*

---

Returns a description of *proc*, including information on where it was defined.

```

def create_proc
 Proc.new
end

my_proc = create_proc { "hello" }
my_proc.to_s → "#<Proc:0x001c7abc@prog.rb:5>"

```

**Module**

# Process

The Process module is a collection of methods used to manipulate processes. Programs that want to manipulate real and effective user and group IDs should also look at the `Process::GID`, and `Process::UID` modules. Much of the functionality here is duplicated in the `Process::Sys` module.

## Module constants

---

<code>PRIO_PGRP</code>	Process group priority.
<code>PRIO_PROCESS</code>	Process priority.
<code>PRIO_USER</code>	User priority.
<code>WNOHANG</code>	Do not block if no child has exited. Not available on all platforms.
<code>WUNTRACED</code>	Return stopped children as well. Not available on all platforms.

## Module methods

---

**abort** abort  
abort(*msg*)

---

1.8 Synonym for `Kernel.abort`.

**detach** `Process.detach(pid) → thread`

---

1.8 Some operating systems retain the status of terminated child processes until the parent collects that status (normally using some variant of `wait()`). If the parent never collects this status, the child stays around as a *zombie* process. `Process.detach` prevents this by setting up a separate Ruby thread whose sole job is to reap the status of the process *pid* when it terminates. Use `detach` only when you do not intend to explicitly wait for the child to terminate. `detach` checks the status only periodically (currently once each second).

In this first example, we don't reap the first child process, so it appears as a zombie in the process status display.

```
pid = fork { sleep 0.1 }
sleep 1
system("ps -o pid,state -p #{pid}")
```

*produces:*

```
PID STAT
27836 ZN+
```

In the next example, `Process.detach` is used to reap the child automatically—no child processes are left running.

```
pid = fork { sleep 0.1 }
Process.detach(pid)
sleep 1
```

```
system("ps -o pid,state -p #{pid}")
```

*produces:*

```
PID STAT
```

---

**egid** Process.egid → *int*

---

Returns the effective group ID for this process.

```
Process.egid → 502
```

---

**egid=** Process.egid= *int* → *int*

---

Sets the effective group ID for this process.

---

**uid** Process.uid → *int*

---

Returns the effective user ID for this process.

```
Process.uid → 502
```

---

**uid=** Process.uid= *int*

---

Sets the effective user ID for this process. Not available on all platforms.

---

**exit** Process.exit( *int*=0 )

---

1.8 Synonym for `Kernel.exit`.

---

**exit!** Process.exit!( *true* | *false* | *status*=1 )

---

1.8 Synonym for `Kernel.exit!`. No exit handlers are run. 0, 1, or *status* is returned to the underlying system as the exit status.

```
Process.exit!(0)
```

---

**fork** Process.fork < { *block* } > → *int* or *nil*

---

See `Kernel.fork` on page 501.

---

**getpgid** Process.getpgid( *int* ) → *int*

---

Returns the process group ID for the given process id. Not available on all platforms.

```
Process.getpgid(Process.ppid()) → 25122
```

---

**getpgrp** Process.getpgrp → *int*

---

Returns the process group ID for this process. Not available on all platforms.

```
Process.getpgid(0) → 25122
```

```
Process.getpgrp → 25122
```

---

**getpriority** Process.getpriority( *kind*, *int* ) → *int*

---

Gets the scheduling priority for specified process, process group, or user. *kind* indicates the kind of entity to find: one of `Process::PRIO_PGRP`, `Process::PRIO_USER`, or `Process::PRIO_PROCESS`. *int* is an ID indicating the particular process, process group, or user (an ID of 0 means *current*). Lower priorities are more favorable for scheduling. Not available on all platforms.

```
Process.getpriority(Process::PRIO_USER, 0) → 19
Process.getpriority(Process::PRIO_PROCESS, 0) → 19
```

---

**gid** Process.gid → *int*

---

Returns the group ID for this process.

```
Process.gid → 502
```

---

**gid=** Process.gid= *int* → *int*

---

Sets the group ID for this process.

---

**groups** Process.groups → *groups*

---

1.8 Returns an array of integer supplementary group IDs. Not available on all platforms. See also `Process.maxgroups`.

```
Process.groups → [502, 79, 80, 81]
```

---

**groups=** Process.groups = *array* → *groups*

---

1.8 Sets the supplementary group IDs from the given array, which may contain either numbers of group names (as strings). Not available on all platforms. Only available to superusers. See also `Process.maxgroups`.

---

**initgroups** Process.initgroups( *user*, *base\_group* ) → *groups*

---

1.8 Initializes the group access list using the operating system's `initgroups` call. Not available on all platforms. May require superuser privilege.

```
Process.initgroups("dave", 500)
```

---

**kill** Process.kill( *signal*, <*pid*><sup>+</sup> ) → *int*

---

Sends the given signal to the specified process ID(s) or to the current process if *pid* is zero. *signal* may be an integer signal number or a POSIX signal name (either with or without a SIG prefix). If *signal* is negative (or starts with a - sign), kills process groups instead of processes. Not all signals are available on all platforms.

```
pid = fork do
 Signal.trap("USR1") { puts "Ouch!"; exit }
 # ... do some work ...
end
```



```
...
Process.kill("USR1", pid)
Process.wait

produces:
-:2: SIGUSR1 (SignalException)
from -:1:in `fork'
from -:1
```

---

## maxgroups Process.maxgroups → *count*

---

1.8 The Process module has a limit on the number of supplementary groups it supports in the calls `Process.groups` and `Process.groups=`. The `maxgroups` call returns that limit (by default 32), and the `maxgroups=` call sets it.

```
Process.maxgroups → 32
Process.maxgroups = 64
Process.maxgroups → 64
```

---

## maxgroups= Process.maxgroups= *limit* → *count*

---

1.8 Sets the maximum number of supplementary group IDs that can be processed by the `groups` and `groups=` methods. If a number larger than 4096 is given, 4096 will be used.

---

## pid Process.pid → *int*

---

Returns the process ID of this process. Not available on all platforms.

```
Process.pid → 27864
```

---

## ppid Process.ppid → *int*

---

Returns the process ID of the parent of this process. Always returns 0 on Windows. Not available on all platforms.

```
puts "I am #{Process.pid}"
Process.fork { puts "Dad is #{Process.ppid}" }
```

*produces:*

```
I am 27866
Dad is 27866
```

---

## setpgid Process.setpgid(*pid*, *int*) → 0

---

Sets the process group ID of *pid* (0 indicates this process) to *int*. Not available on all platforms.

---

## setpgrp Process.setpgrp → 0

---

Equivalent to `setpgid(0,0)`. Not available on all platforms.

---

**setpriority** Process.setpriority( *kind*, *int*, *int\_priority* ) → 0

---

See Process#getpriority.

```
Process.setpriority(Process::PRIO_USER, 0, 19) → 0
Process.setpriority(Process::PRIO_PROCESS, 0, 19) → 0
Process.getpriority(Process::PRIO_USER, 0) → 19
Process.getpriority(Process::PRIO_PROCESS, 0) → 19
```

---

**setsid** Process.setsid → *int*

---

Establishes this process as a new session and process group leader, with no controlling tty. Returns the session ID. Not available on all platforms.

```
Process.setsid → 27871
```

---

**times** Process.times → *struct\_tms*

---

1.8 Returns a Tms structure (see Struct::Tms on page 609) that contains user and system CPU times for this process.

```
t = Process.times
[t.utime, t.stime] → [0.01, 0.01]
```

---

**uid** Process.uid → *int*

---

Returns the user ID of this process.

```
Process.uid → 502
```

---

**uid=** Process.uid= *int* → *numeric*

---

Sets the (integer) user ID for this process. Not available on all platforms.

---

**wait** Process.wait → *int*

---

Waits for any child process to exit and returns the process ID of that child. Also sets \$? to the Process::Status object containing information on that process. Raises a SystemError if there are no child processes. Not available on all platforms.

```
Process.fork { exit 99 } → 27878
Process.wait → 27878
$?.exitstatus → 99
```

---

**waitall** Process.waitall → [ [ *pid*, *status* ], ... ]

---

1.8 Waits for all children, returning an array of *pid/status* pairs (where *status* is an object of class Process::Status).

```

fork { sleep 0.2; exit 2 } → 27881
fork { sleep 0.1; exit 1 } → 27882
fork { exit 0 } → 27883
Process.waitall → [[27883, #<Process::Status:
 pid=27883,exited(0)>], [27882,
 #<Process::Status:
 pid=27882,exited(1)>], [27881,
 #<Process::Status:
 pid=27881,exited(2)>]]

```

---

**wait2** Process.wait2 → [ *pid*, *status* ]

---

1.8

Waits for any child process to exit and returns an array containing the process ID and the exit status (a `Process::Status` object) of that child. Raises a `SystemError` if no child processes exist.

```

Process.fork { exit 99 } → 27886
pid, status = Process.wait2
pid → 27886
status.exitstatus → 99

```

---

**waitpid** Process.waitpid(*pid*, *int=0*) → *pid*

---

Waits for a child process to exit depending on the value of *pid*:

- < -1 Any child whose progress group ID equals the absolute value of *pid*.
- 1 Any child (equivalent to `wait`).
- 0 Any child whose process group ID equals that of the current process.
- > 0 The child with the given PID.

*int* may be a logical or of the flag values `Process::WNOHANG` (do not block if no child available) or `Process::WUNTRACED` (return stopped children that haven't been reported). Not all flags are available on all platforms, but a flag value of zero will work on all platforms.

```

include Process
pid = fork { sleep 3 } → 27889
Time.now → Thu Aug 26 22:38:17 CDT 2004
waitpid(pid, Process::WNOHANG) → nil
Time.now → Thu Aug 26 22:38:17 CDT 2004
waitpid(pid, 0) → 27889
Time.now → Thu Aug 26 22:38:20 CDT 2004

```

---

**waitpid2** Process.waitpid2(*pid*, *int=0*) → [ *pid*, *status* ]

---

Waits for the given child process to exit, returning that child's process ID and exit status (a `Process::Status` object). *int* may be a logical or of the values `Process::WNOHANG` (do not block if no child available) or `Process::WUNTRACED` (return stopped children that haven't been reported). Not all flags are available on all platforms, but a flag value of zero will work on all platforms.

## Module **Process::GID**

Provides a higher-level (and more portable) interface to the underlying operating system's concepts of real, effective, and saved group IDs. Discussing of the semantics of these IDs is well beyond the scope of this book: readers who want to know more should consult POSIX documentation or read the `intro(2)` man pages on a recent Unix platform. All these methods throw `NotImplementedError` if the host operating does not support a sufficient set of calls. The descriptions that follow are based on notes in `ruby-talk:76218` by Hidetoshi Nagai.

### Module methods

<b>change_privilege</b>	<code>Process::GID.change_privilege(<i>gid</i>) → <i>gid</i></code>
<u>1.8</u>	Sets the real, effective, and saved group IDs to <i>gid</i> , raising an exception on failure (in which case the state of the IDs is not known).
	This method is not compatible with <code>Process.gid=</code> .
<b>eid</b>	<code>Process::GID.eid → <i>egid</i></code>
<u>1.8</u>	Returns the effective group ID for this process. Synonym for <code>Process.egid</code> .
<b>eid=</b>	<code>Process::GID.eid = <i>egid</i></code>
<u>1.8</u>	Synonym for <code>Process::GID.grant_privilege</code> .
<b>grant_privilege</b>	<code>Process::GID.grant_privilege(<i>egid</i>) → <i>egid</i></code>
<u>1.8</u>	Sets the effective group ID to <i>egid</i> , raising an exception on failure. One some environments this may also change the saved group ID (see <code>re_exchangeable?</code> ).
<b>re_exchange</b>	<code>Process::GID.re_exchange → <i>egid</i></code>
<u>1.8</u>	Exchange the real and effective group IDs, setting the saved group ID to the new effective group ID. Returns the new effective group ID.
<b>re_exchangeable?</b>	<code>Process::GID.re_exchangeable → true or false</code>
<u>1.8</u>	Returns <code>true</code> if real and effective group IDs can be exchanged on the host operating system, and returns <code>false</code> otherwise.
<b>rid</b>	<code>Process::GID.rid → <i>gid</i></code>
<u>1.8</u>	Returns the real group ID for this process. Synonym for <code>Process.gid</code> .
<b>sid_available?</b>	<code>Process::GID.sid_available? → true or false</code>
<u>1.8</u>	Returns <code>true</code> if the underlying platform supports saved group IDs, and returns <code>false</code>

otherwise. Currently, Ruby assumes support if the operating system has `setresgid(2)` or `setegid(2)` calls or if the configuration includes the `POSIX_SAVED_IDS` flag.

---

**switch**

`Process::GID.switch` → *egid*

`Process::GID.switch { block }` → *obj*

---

1.8

Handles the toggling of group privilege. In the block form, automatically toggles the IDs back when the block terminates (but only if the block doesn't use other calls into `Process::GID` calls which would interfere). Without a block, returns the original effective group ID.

## Class **Process::Status** < Object

`Process::Status` encapsulates the information on the status of a running or terminated system process. The built-in variable `$?` is either `nil` or a `Process::Status` object.

```
fork { exit 99 } → 27186
Process.wait → 27186
$?.class → Process::Status
$?.to_i → 25344
$? >> 8 → 99
$?.stopped? → false
$?.exited? → true
$?.exitstatus → 99
```

POSIX systems record information on processes using a 16-bit integer. The lower bits recorded the process status (stopped, exited, signaled), and the upper bits possibly contain additional information (for example, the program's return code in the case of exited processes). Before Ruby 1.8, these bits were exposed directly to the Ruby program. Ruby now encapsulates these in a `Process::Status` object. To maximize compatibility, however, these objects retain a bit-oriented interface. In the descriptions that follow, when we talk about the integer value of `stat`, we're referring to this 16-bit value.

### Instance methods

---

**==** *stat == other* → true or false

Returns true if the integer value of `stat` equals `other`.

---

**&** *stat & num* → fixnum

Logical AND of the bits in `stat` with `num`.

```
fork { exit 0x37 }
Process.wait
sprintf('%04x', $?.to_i) → "3700"
sprintf('%04x', $? & 0x1e00) → "1600"
```

---

**>>** *stat >> num* → fixnum

Shift the bits in `stat` right `num` places.

```
fork { exit 99 } → 27192
Process.wait → 27192
$?.to_i → 25344
$? >> 8 → 99
```

---

**coredump?** *stat.coredump* → true or false

Returns true if `stat` generated a core dump when it terminated. Not available on all platforms.

---

**exited?** *stat.exited?* → true or false

Returns true if *stat* exited normally (for example using an `exit` call or finishing the program).

---

**exitstatus** *stat.exitstatus* → *fixnum* or nil

Returns the least significant 8 bits of the return code of *stat*. Only available if `exited?` is true.

```
fork { } → 27195
Process.wait → 27195
$?.exited? → true
$?.exitstatus → 0

fork { exit 99 } → 27196
Process.wait → 27196
$?.exited? → true
$?.exitstatus → 99
```

---

**pid** *stat.pid* → *fixnum*

Returns the ID of the process associated with this status object.

```
fork { exit } → 27199
Process.wait → 27199
$?.pid → 27199
```

---

**signaled?** *stat.signaled?* → true or false

Returns true if *stat* terminated because of an uncaught signal.

```
pid = fork { sleep 100 }
Process.kill(9, pid) → 1
Process.wait → 27202
$?.signaled? → true
```

---

**stopped?** *stat.stopped?* → true or false

Returns true if this process is stopped. This is returned only if the corresponding `wait` call had the `WUNTRACED` flag set.

---

**success?** *stat.success?* → nil, or true or false

Returns true if *stat* refers to a process that exited successfully, returns false if it exited with a failure, and returns nil if *stat* does not refer to a process that has exited.

---

**stopsig** *stat.stopsig* → *fixnum* or nil

Returns the number of the signal that caused *stat* to stop (or nil if self is not stopped).

---

**termsig** *stat.termsig* → *fixnum* or *nil*

---

Returns the number of the signal that caused *stat* to terminate (or *nil* if self was not terminated by an uncaught signal).

---

**to\_i** *stat.to\_i* → *fixnum*

---

Returns the bits in *stat* as a *Fixnum*. Poking around in these bits is platform dependent.

```
fork { exit 0xab } → 27205
Process.wait → 27205
sprintf('%04x', $? .to_i) → "ab00"
```

---

**to\_int** *stat.to\_int* → *fixnum*

---

Synonym for `Process::Status#to_i`.

---

**to\_s** *stat.to\_s* → *string*

---

Equivalent to `stat.to_i.to_s`.



## Module **Process::Sys**

`Process::Sys` provides system call–level access to the process user and group environment. Many of the calls are aliases of those in the `Process` module and are packaged here for completeness. See also `Process::GID` and `Process::UID` for a higher-level (and more portable) interface.

### Module methods

<b>getegid</b>	<code>Process::Sys.getegid</code> → <i>gid</i>
<u>1.8</u>	Returns the effective group ID for this process. Synonym for <code>Process.egid</code> .
<b>geteuid</b>	<code>Process::Sys.geteuid</code> → <i>uid</i>
<u>1.8</u>	Returns the effective user ID for this process. Synonym for <code>Process.euid</code> .
<b>getgid</b>	<code>Process::Sys.getgid</code> → <i>gid</i>
<u>1.8</u>	Returns the group ID for this process. Synonym for <code>Process.gid</code> .
<b>getuid</b>	<code>Process::Sys.getuid</code> → <i>uid</i>
<u>1.8</u>	Returns the user ID for this process. Synonym for <code>Process.uid</code> .
<b>issetugid</b>	<code>Process::Sys.issetugid</code> → true or false
<u>1.8</u>	Returns true if this process was made <code>setuid</code> or <code>setgid</code> as a result of the last <code>execve()</code> system call, and returns false if not. On systems that don't support <code>issetugid(2)</code> , throws <code>NotImplementedError</code> .
<b>setegid</b>	<code>Process::Sys.setegid( gid )</code>
<u>1.8</u>	Set the effective group ID to <i>gid</i> , failing if the underlying system call fails. On systems that don't support <code>setegid(2)</code> , throws <code>NotImplementedError</code> .
<b>seteuid</b>	<code>Process::Sys.seteuid( uid )</code>
<u>1.8</u>	Set the effective user ID to <i>uid</i> , failing if the underlying system call fails. On systems that don't support <code>seteuid(2)</code> , throws <code>NotImplementedError</code> .
<b>setgid</b>	<code>Process::Sys.setgid( gid )</code>
<u>1.8</u>	Set the group ID to <i>gid</i> , failing if the underlying system call fails. On systems that don't support <code>setgid(2)</code> , throws <code>NotImplementedError</code> .
<b>setregid</b>	<code>Process::Sys.setregid( rgid, egid )</code>
<u>1.8</u>	Set the real and effective group IDs to <i>rgid</i> and <i>egid</i> , failing if the underlying system call fails. On systems that don't support <code>setregid(2)</code> , throws <code>NotImplementedError</code> .

---

**setresgid** Process::Sys.setresgid( *rgid*, *egid*, *sgid* )

---

1.8 Set the real, effective, and saved group IDs to *rgid*, *egid*, and *sgid*, failing if the underlying system call fails. On systems that don't support `setresgid(2)`, throws `NotImplementedError`.

---

**setresuid** Process::Sys.setresuid( *ruid*, *euid*, *suid* )

---

1.8 Set the real, effective, and saved user IDs to *ruid*, *euid*, and *suid*, failing if the underlying system call fails. On systems that don't support `setresuid(2)`, throws `NotImplementedError`.

---

**setreuid** Process::Sys.setreuid( *ruid*, *euid* )

---

1.8 Set the real and effective user IDs to *ruid* and *euid*, failing if the underlying system call fails. On systems that don't support `setreuid(2)`, throws `NotImplementedError`.

---

**setrgid** Process::Sys.setrgid( *rgid* )

---

1.8 Set the real group ID to *rgid*, failing if the underlying system call fails. On systems that don't support `setrgid(2)`, throws `NotImplementedError`.

---

**setruid** Process::Sys.setruid( *ruid* )

---

1.8 Set the real user ID to *ruid*, failing if the underlying system call fails. On systems that don't support `setruid(2)`, throws `NotImplementedError`.

---

**setuid** Process::Sys.setuid( *uid* )

---

1.8 Set the user ID to *uid*, failing if the underlying system call fails. On systems that don't support `setuid(2)`, throws `NotImplementedError`.

**Module**  
**Process::UID**

Provides a higher-level (and more portable) interface to the underlying operating system's concepts of real, effective, and saved user IDs. For more information, see the introduction to `Process::GID` on page 568.

**Module methods**

---

**change\_privilege** Process::UID.change\_privilege(*uid*) → *uid*

---

1.8 Sets the real, effective, and saved user IDs to *uid*, raising an exception on failure (in which case the state of the IDs is not known). Not compatible with `Process.uid=`.

---



---

**eid** Process::UID.eid → *eid*

---

1.8 Returns the effective user ID for this process. Synonym for `Process.eid`.

---



---

**eid=** Process::UID.eid = *eid*

---

1.8 Synonym for `Process::UID.grant_privilege`.

---



---

**grant\_privilege** Process::UID.grant\_privilege(*eid*) → *eid*

---

1.8 Sets the effective user ID to *eid*, raising an exception on failure. One some environments this may also change the saved user ID.

---



---

**re\_exchange** Process::UID.re\_exchange → *eid*

---

1.8 Exchange the real and effective user IDs, setting the saved user ID to the new effective user ID. Returns the new effective user ID.

---



---

**re\_exchangeable?** Process::UID.re\_exchangeable → true or false

---

1.8 Returns true if real and effective user IDs can be exchanged on the host operating system, and returns false otherwise.

---



---

**rid** Process::UID.rid → *uid*

---

1.8 Returns the real user ID for this process. Synonym for `Process.uid`.

---



---

**sid\_available?** Process::UID.sid\_available? → true or false

---

1.8 Returns true if the underlying platform supports saved user IDs, and returns false otherwise. Currently, Ruby assumes support if the operating system has `setresuid(2)` or `seteuid(2)` calls, or if the configuration includes the `POSIX_SAVED_IDS` flag.

---



---

**switch** Process::UID.switch → *eid*

---

Process::UID.switch { *block* } → *obj*

---

1.8 Handles the toggling of user privilege. In the block form, automatically toggles the IDs back when the block terminates (as long as the block doesn't use other `Process::UID` calls to interfere). Without a block, returns the original effective user ID.

---

## Class Range < Object

A Range represents an interval—a set of values with a start and an end. Ranges may be constructed using the *s..e* and *s...e* literals or using `Range.new`. Ranges constructed using `..` run from the start to the end inclusively. Those created using `...` exclude the end value. When used as an iterator, ranges return each value in the sequence.

```
(-1..-5).to_a → []
(-5..-1).to_a → [-5, -4, -3, -2, -1]
('a'..'e').to_a → ["a", "b", "c", "d", "e"]
('a'...'e').to_a → ["a", "b", "c", "d"]
```

Ranges can be constructed using objects of any type, as long as the objects can be compared using their `<=>` operator and they support the `succ` method to return the next object in sequence.

```
class Xs # represent a string of 'x's
 include Comparable
 attr :length
 def initialize(n)
 @length = n
 end
 def succ
 Xs.new(@length + 1)
 end
 def <=>(other)
 @length <=> other.length
 end
 def to_s
 sprintf "%2d #{inspect}", @length
 end
 def inspect
 'x' * @length
 end
end

r = Xs.new(3)..Xs.new(6) → xxx..xxxxxxx
r.to_a → [xxx, xxxx, xxxxx, xxxxxx]
r.member?(Xs.new(5)) → true
```

In the previous code example, class `Xs` includes the `Comparable` module. This is because `Enumerable#member?` checks for equality using `==`. Including `Comparable` ensures that the `==` method is defined in terms of the `<=>` method implemented in `Xs`.

## Mixes in

### Enumerable:

```
all?, any?, collect, detect, each_with_index, entries, find, find_all,
grep, include?, inject, map, max, member?, min, partition, reject,
select, sort, sort_by, to_a, zip
```

## Class methods

**new** `Range.new( start, end, exclusive=false ) → rng`

Constructs a range using the given *start* and *end*. If the third parameter is omitted or is false, the range will include the end object; otherwise, it will be excluded.

## Instance methods

**==** `rng == obj → true or false`

Returns true if *obj* is a range whose beginning and end are the same as those in *rng* (compared using ==) and whose *exclusive* flag is the same as *rng*.

**===** `rng === val → true or false`

1.8

If *rng* excludes its end, returns  $rng.start \leq val < rng.end$ . If *rng* is inclusive returns  $rng.start \leq val \leq rng.end$ . Note that this implies that *val* need not be a member of the range itself (for example a float could fall between the start and end values of a range of integers). Conveniently, the === operator is used by case statements.

```
case 74.95
when 1...50 then puts "low"
when 50...75 then puts "medium"
when 75...100 then puts "high"
end
```

*produces:*

medium

**begin** `rng.begin → obj`

Returns the first object of *rng*.

**each** `rng.each { |i| block } → rng`

Iterates over the elements *rng*, passing each in turn to the block. Successive elements are generated using the succ method.

```
(10..15).each do |n|
 print n, ' '
end
```

*produces:*

10 11 12 13 14 15

**end** `rng.end → obj`

Returns the object that defines the end of *rng*.

```
(1..10).end → 10
(1...10).end → 10
```

---

**eql?** *rng.eql?(obj) → true or false*

Returns true if *obj* is a range whose beginning and end are the same as those in *rng* (compared using eql?) and whose *exclusive* flag is the same as *rng*.

---

**exclude\_end?** *rng.exclude\_end? → true or false*

Returns true if *rng* excludes its end value.

---

**first** *rng.first → obj*

Synonym for Range#begin.

---

**include?** *rng.include?(val) → true or false*

Synonym for Range#===.

---

**last** *rng.last → obj*

Synonym for Range#end.

---

**member?** *rng.member?(val) → true or false*

Return true if *val* is one of the values in *rng* (that is if Range#each would return *val* at some point).

```
r = 1..10
r.include?(5) → true
r.member?(5) → true
r.include?(5.5) → true
r.member?(5.5) → false
```

---

**step** *rng.step(n=1) {|obj| block } → rng*

1.8

Iterates over *rng*, passing each  $n^{\text{th}}$  element to the block. If the range contains numbers, addition by one is used to generate successive elements. Otherwise *step* invokes *succ* to iterate through range elements. The following code uses class *Xs* defined at the start of this section.

```
range = Xs.new(1)..Xs.new(10)
range.step(2) {|x| puts x}
range.step(3) {|x| puts x}
```

*produces:*

```
1 x
3 xxx
5 xxxxx
7 xxxxxxx
9 xxxxxxxxx
1 x
4 xxxx
7 xxxxxxx
10 xxxxxxxxx
```

**Class** **Regexp** < Object

A `Regexp` holds a regular expression, used to match a pattern against strings. `Regexp`s are created using the `/.../` and `%r...` literals and using the `Regexp.new` constructor. This section documents Ruby 1.8 regular expressions. Later versions of Ruby use a different regular expression engine.

**Class constants**

`EXTENDED` Ignore spaces and newlines in `regexp`.  
`IGNORECASE` Matches are case insensitive.  
`MULTILINE` Newlines treated as any other character.

**Class methods**

**compile** `Regexp.compile(pattern <, options <, lang >>)` → *rxp*

Synonym for `Regexp.new`.

**escape** `Regexp.escape(string)` → *escaped\_string*

Escapes any characters that would have special meaning in a regular expression. For any string, `Regexp.escape(str) =~ str` will be true.

```
Regexp.escape('\[\] *?{. ') → '\\[\\] *?\\{\\. \\'
```

**last\_match** `Regexp.last_match` → *match*  
`Regexp.last_match(int)` → *string*

1.8 The first form returns the `MatchData` object generated by the last successful pattern match. This is equivalent to reading the global variable `$~`. `MatchData` is described on page 516. The second form returns the  $n^{th}$  field in this `MatchData` object.

```
/c(.)t/ =~ 'cat' → 0
Regexp.last_match → #<MatchData:0x1c9468>
Regexp.last_match(0) → "cat"
Regexp.last_match(1) → "a"
Regexp.last_match(2) → nil
```

**new** `Regexp.new(string <, options <, lang >>)` → *rxp*  
`Regexp.new(regexp)` → *new\_regexp*

1.8 Constructs a new regular expression from *pattern*, which can be either a `String` or a `Regexp`. In the latter case that `regexp`'s options are propagated, and new options may not be specified (a change as of Ruby 1.8). If *options* is a `Fixnum`, it should be one or more of `Regexp::EXTENDED`, `Regexp::IGNORECASE`, and `Regexp::POSIXLINE`, or-ed together. Otherwise, if *options* is not `nil`, the `regexp` will be case insensitive. The *lang*

parameter enables multibyte support for the regexp: n, N, or nil = none, e, E = EUC, s, S = SJIS, u, U = UTF-8.

```
r1 = Regexp.new('[a-z]+:\\s+\\w+') → /^[a-z]+:\\s+\\w+/
r2 = Regexp.new('cat', true) → /cat/i
r3 = Regexp.new('dog', Regexp::EXTENDED) → /dog/x
r4 = Regexp.new(r2) → /cat/i
```

---

**quote** *Regexp.quote(string) → escaped\_string*

---

Synonym for `Regexp.escape`.

## Instance methods

---

**==** *rxp == other\_regexp → true or false*

---

Equality—Two regexps are equal if their patterns are identical, they have the same character set code, and their `casefold?` values are the same.

```
/abc/ == /abc/x → false
/abc/ == /abc/i → false
/abc/u == /abc/n → false
```

---

**===** *rxp === string → true or false*

---

Case Equality—Synonym for `Regexp#=~` used in case statements.

```
a = "HELLO"
case a
when /^[a-z]*$/; print "Lower case\n"
when /^[A-Z]*$/; print "Upper case\n"
else print "Mixed case\n"
end
```

*produces:*

```
Upper case
```

---

**=~** *rxp =~ string → int or nil*

---

Match—Matches *rxp* against *string*, returning the offset of the start of the match or `nil` if the match failed. Sets `$~` to the corresponding `MatchData` or `nil`.

```
/SIT/ =~ "insensitive" → nil
/SIT/i =~ "insensitive" → 5
```

---

**~** *~ rxp → int or nil*

---

Match—Matches *rxp* against the contents of `$_`. Equivalent to `rxp =~ $_`.

```
$_ = "input data"
~/at/ → 7
```



---

**casefold?** *rxp.casefold?* → true or false

---

Returns the value of the case-insensitive flag.

---

**inspect** *rxp.inspect* → string

---

Returns a readable version of *rxp*.

```
/cat/mi.inspect → "/cat/mi"
/cat/mi.to_s → "(?mi-x:cat)"
```

---

**kcode** *rxp.kcode* → string

---

Returns the character set code for the regexp.

```
/cat/.kcode → nil
/cat/s.kcode → "sjis"
```

---

**match** *rxp.match(string)* → match or nil

---

Returns a MatchData object (see page 516) describing the match, returns or nil if there was no match. This is equivalent to retrieving the value of the special variable \$~ following a normal match.

```
/(.)(.)(.)/.match("abc")[2] → "b"
```

---

**options** *rxp.options* → int

---

1.8

Returns the set of bits corresponding to the options used when creating this Regexp (see Regexp.new for details). Note that additional bits may be set in the returned options: these are used internally by the regular expression code. These extra bits are ignored if the options are passed to Regexp.new.

```
Let's see what the values are...
Regexp::IGNORECASE → 1
Regexp::EXTENDED → 2
Regexp::MULTILINE → 4

/cat/.options → 0
/cat/ix.options → 3
Regexp.new('cat', true).options → 1
Regexp.new('cat', 0, 's').options → 48

r = /cat/ix
Regexp.new(r.source, r.options) → /cat/ix
```

---

**source** *rxp.source* → string

---

Returns the original string of the pattern.

```
/ab+c/ix.source → "ab+c"
```

---

**to\_s***rxp.to\_s → string*

Returns a string containing the regular expression and its options (using the `(?xx:yyy)` notation). This string can be fed back in to `Regexp.new` to a regular expression with the same semantics as the original. (However, `Regexp#==` may not return true when comparing the two, as the source of the regular expression itself may differ, as the example shows.) `Regexp#inspect` produces a generally more readable version of *rxp*.

```
r1 = /ab+c/ix → /ab+c/ix
s1 = r1.to_s → "(?ix-m:ab+c)"
r2 = Regexp.new(s1) → /(?ix-m:ab+c)/
r1 == r2 → false
r1.source → "ab+c"
r2.source → "(?ix-m:ab+c)"
```

## Module **Signal**

Many operating systems allow signals to be sent to running processes. Some signals have a defined effect on the process, and others may be trapped at the code level and acted upon. For example, your process may trap the USR1 signal and use it to toggle debugging, and it may use TERM to initiate a controlled shutdown.

```
pid = fork do
 Signal.trap("USR1") do
 $debug = !$debug
 puts "Debug now: #{$debug}"
 end
 Signal.trap("TERM") do
 puts "Terminating..."
 shutdown()
 end
 # . . . do some work . . .
end
Process.detach(pid)
Controlling program:
Process.kill("USR1", pid)
...
Process.kill("USR1", pid)
...
Process.kill("TERM", pid)
```

*produces:*

```
Debug now: true
Debug now: false
Terminating...
```

The list of available signal names and their interpretation is system dependent. Signal delivery semantics may also vary between systems; in particular signal delivery may not always be reliable.

## Module methods

### list

Signal.list → *hash*

Returns a list of signal names mapped to the corresponding underlying signal numbers.

```
Signal.list → {"ABRT"=>6, "ALRM"=>14, "BUS"=>10, "CHLD"=>20,
"CLD"=>20, "CONT"=>19, "EMT"=>7, "FPE"=>8, "HUP"=>1,
"ILL"=>4, "INFO"=>29, "INT"=>2, "IO"=>23, "IOT"=>6,
"KILL"=>9, "PIPE"=>13, "PROF"=>27, "QUIT"=>3,
"SEGV"=>11, "STOP"=>17, "SYS"=>12, "TERM"=>15,
"TRAP"=>5, "TSTP"=>18, "TTIN"=>21, "TTOU"=>22,
"URG"=>16, "USR1"=>30, "USR2"=>31, "VTALRM"=>26,
"WINCH"=>28, "XCPU"=>24, "XFSZ"=>25}
```

**trap**Signal.trap( *signal*, *proc* ) → *obj*Signal.trap( *signal* ) { *block* } → *obj*

Specifies the handling of signals. The first parameter is a signal name (a string such as SIGALRM, SIGUSR1, and so on) or a signal number. The characters SIG may be omitted from the signal name. The command or block specifies code to be run when the signal is raised. If the command is the string IGNORE or SIG\_IGN, the signal will be ignored. If the command is DEFAULT or SIG\_DFL, the operating system's default handler will be invoked. If the command is EXIT, the script will be terminated by the signal. Otherwise, the given command or block will be run.

The special signal name EXIT or signal number zero will be invoked just prior to program termination.

trap returns the previous handler for the given signal.

```
Signal.trap(0, lambda { puts "Terminating: #{$$}" })
Signal.trap("CLD") { puts "Child died" }
fork && Process.wait
```

*produces:*

```
Terminating: 27913
Child died
Terminating: 27912
```

**Class** **String** < Object

A `String` object holds and manipulates a sequence of bytes, typically representing characters. `String` objects may be created using `String.new` or as literals (see page 305).

Because of aliasing issues, users of strings should be aware of the methods that modify the contents of a `String` object. Typically, methods with names ending in `!` modify their receiver, while those without a `!` return a new `String`. However, exceptions exist, such as `String#[ ]=`.

**Mixes in****Comparable:**

`<`, `<=`, `==`, `>=`, `>`, `between?`

**Enumerable:**

`all?`, `any?`, `collect`, `detect`, `each_with_index`, `entries`, `find`, `find_all`, `grep`, `include?`, `inject`, `map`, `max`, `member?`, `min`, `partition`, `reject`, `select`, `sort`, `sort_by`, `to_a`, `zip`

**Class methods**

**new** `String.new( val="" ) → str`

1.8 Returns a new string object containing a copy of *val* (which should be a `String` or implement `to_str`).

```
str1 = "wibble"
str2 = String.new(str1)
str1.object_id → 936550
str2.object_id → 936540
str1[1] = "o"
str1 → "wobble"
str2 → "wibble"
```

**Instance methods**

**%** `str % arg → string`

**Format**—Uses *str* as a format specification, and returns the result of applying it to *arg*. If the format specification contains more than one substitution, then *arg* must be an `Array` containing the values to be substituted. See `Kernel.sprintf` on page 508 for details of the format string.

```
"%05d" % 123 → "00123"
"%-5s: %08x" % ["ID", self.id] → "ID_...:_000ec4dc"
```

---

**\*** *str \* int → string*

Copies—Returns a new String containing *int* copies of the receiver.

```
"Ho! " * 3 → "Ho! Ho! Ho! "
```

---

**+** *str + string → string*

Concatenation—Returns a new String containing *string* concatenated to *str*.

```
"Hello from " + self.to_s → "Hello from main"
```

---

**<<** *str << fixnum → str*  
*str << obj → str*

Append—Concatenates the given object to *str*. If the object is a Fixnum between 0 and 255, it is converted to a character before concatenation.

```
a = "hello "
a << "world" → "hello world"
a << 33 → "hello world!"
```

---

**<=>** *str <=> other\_string → -1, 0, +1*

Comparison—Returns  $-1$  if *str* is less than,  $0$  if *str* is equal to, and  $+1$  if *str* is greater than *other\_string*. If the strings are of different lengths, and the strings are equal when compared up to the shortest length, then the longer string is considered greater than the shorter one. If the variable `$=` is false, the comparison is based on comparing the binary values of each character in the string. In older versions of Ruby, setting `$=` allowed case-insensitive comparisons; this is now deprecated in favor of using `String#casecmp`.

1.8

`<=>` is the basis for the methods `<`, `<=`, `>`, `>=`, and `between?`, included from module `Comparable`. The method `String#==` does not use `Comparable#==`.

```
"abcdef" <=> "abcde" → 1
"abcdef" <=> "abcdef" → 0
"abcdef" <=> "abcdefg" → -1
"abcdef" <=> "ABCDEF" → 1
```

---

**==** *str == obj → true or false*

Equality—If *obj* is a String, returns true if *str* `<=>` *obj* equals zero; returns false otherwise. If *obj* is not a String but responds to `to_str`, return *obj* `==` *str*; otherwise returns false.

1.8

```
"abcdef" == "abcde" → false
"abcdef" == "abcdef" → true
```

---

**===** *str === obj → true or false*

Case Equality—Synonym for `String#===`.

---

```
=~ str =~ regexp → int or nil
```

1.8 Match—Equivalent to `regexp =~ str`. Prior versions of Ruby permitted an arbitrary operand to `=~`; this is now deprecated. Returns the position the match starts, or returns `nil` if there is no match.

```
"cat o' 9 tails" =~ /\d/ → 7
```

---

```
[] str[int] → int or nil
```

```
str[int, int] → string or nil
```

```
str[range] → string or nil
```

```
str[regexp] → string or nil
```

```
str[regexp, int] → string or nil
```

```
str[string] → string or nil
```

---

Element Reference—If passed a single *int*, returns the code of the character at that position. If passed two *ints*, returns a substring starting at the offset given by the first, and a length given by the second. If given a range, a substring containing characters at offsets given by the range is returned. In all three cases, if an offset is negative, it is counted from the end of *str*. Returns `nil` if the initial offset falls outside the string and the length is not given, the length is negative, or the beginning of the range is greater than the end.

1.8 If *regexp* is supplied, the matching portion of *str* is returned. If a numeric parameter follows the regular expression, that component of the `MatchData` is returned instead. If a `String` is given, that string is returned if it occurs in *str*. In both cases, `nil` is returned if there is no match.

```
a = "hello there"
a[1] → 101
a[1,3] → "ell"
a[1..3] → "ell"
a[1...3] → "el"
a[-3,2] → "er"
a[-4..-2] → "her"
a[-2..-4] → ""
a[/[aeiou](.)\1/] → "ell"
a[/[aeiou](.)\1/, 0] → "ell"
a[/[aeiou](.)\1/, 1] → "l"
a[/[aeiou](.)\1/, 2] → nil
a[/(..)e/] → "the"
a[/(..)e/, 1] → "th"
a["lo"] → "lo"
a["bye"] → nil
```

---

```
[]= str[int] = int
str[int] = string
str[int, int] = string
str[range] = string
str[regexp] = string
str[regexp, int] = string
str[string] = string
```

---

1.8

Element Assignment—Replaces some or all of the content of *str*. The portion of the string affected is determined using the same criteria as `String#[ ]`. If the replacement string is not the same length as the text it is replacing, the string will be adjusted accordingly. If the regular expression or string is used as the index doesn't match a position in the string, `IndexError` is raised. If the regular expression form is used, the optional second *int* allows you to specify which portion of the match to replace (effectively using the `MatchData` indexing rules). The forms that take a `Fixnum` will raise an `IndexError` if the value is out of range; the `Range` form will raise a `RangeError`, and the `Regexp` and `String` forms will silently ignore the assignment.

```
a = "hello"
a[2] = 96 (a → "he`lo")
a[2, 4] = "xyz" (a → "hexyz")
a[-4, 2] = "xyz" (a → "hxyzlo")
a[2..4] = "xyz" (a → "hexyz")
a[-4..-2] = "xyz" (a → "hxyzlo")
a[/[aeiou](.)\1(.)/] = "xyz" (a → "hxyz")
a[/[aeiou](.)\1(.)/, 1] = "xyz" (a → "hexyzlo")
a[/[aeiou](.)\1(.)/, 2] = "xyz" (a → "hellxyz")
a["1"] = "xyz" (a → "hexyzlo")
a["11"] = "xyz" (a → "hxyzlo")
a[2, 0] = "xyz" (a → "hexyzllo")
```

---

```
~ ~ str → int or nil
```

---

Equivalent to `$_ =~ str`.

---

```
capitalize str.capitalize → string
```

---

Returns a copy of *str* with the first character converted to uppercase and the remainder to lowercase.

```
"hello".capitalize → "Hello"
"HELLO".capitalize → "Hello"
"123ABC".capitalize → "123abc"
```

---

```
capitalize! str.capitalize! → str or nil
```

---

Modifies *str* by converting the first character to uppercase and the remainder to lowercase. Returns `nil` if no changes are made. ⇒



```
a = "hello"
a.capitalize! → "Hello"
a → "Hello"
a.capitalize! → nil
```

---

**casecmp** *str.capitalize!( string ) → -1, 0, +1*

---

1.8 Case-insensitive version of `String#<=>`.

```
"abcdef".casecmp("abcde") → 1
"abcdef".casecmp("abcdef") → 0
"aBcDeF".casecmp("abcdef") → 0
"abcdef".casecmp("abcdefg") → -1
"abcdef".casecmp("ABCDEF") → 0
```

---

**center** *str.center( int, pad=" " ) → string*

---

If *int* is greater than the length of *str*, returns a new `String` of length *int* with *str* centered between the given padding (defaults to spaces); otherwise, returns *str*.

```
"hello".center(4) → "hello"
"hello".center(20) → "_____hello_____"
"hello".center(4, "_-^") → "hello"
"hello".center(20, "_-^") → "_-^_-^hello_-^_-^"
"hello".center(20, "-") → "-----hello-----"
```

---

**chomp** *str.chomp( rs=\$/ ) → string*

---

Returns a new `String` with the given record separator removed from the end of *str* (if present). If `$/` has not been changed from the default Ruby record separator, then `chomp` also removes carriage return characters (that is it will remove `\n`, `\r`, and `\r\n`).

1.8

```
"hello".chomp → "hello"
"hello\n".chomp → "hello"
"hello\r\n".chomp → "hello"
"hello\n\r".chomp → "hello\n"
"hello\r".chomp → "hello"
"hello \n there".chomp → "hello \n there"
"hello".chomp("llo") → "he"
```

---

**chomp!** *str.chomp!( rs=\$/ ) → str or nil*

---

Modifies *str* in place as described for `String#chomp`, returning *str*, or returning `nil` if no modifications were made.

---

**chop** *str.chop → string*

---

Returns a new `String` with the last character removed. If the string ends with `\r\n`, both characters are removed. Applying `chop` to an empty string returns an empty string. `String#chomp` is often a safer alternative, as it leaves the string unchanged if it doesn't end in a record separator.

```

"string\r\n".chop → "string"
"string\n\r".chop → "string\n"
"string\n".chop → "string"
"string".chop → "strin"
"x".chop.chop → ""

```

---

**chop!** *str.chop!* → *str* or nil

Processes *str* as for `String#chop`, returning *str*, or returning nil if *str* is the empty string. See also `String#chomp!`.

---

**concat** *str.concat( int )* → *str*  
*str.concat( obj )* → *str*

Synonym for `String#<<`.

---

**count** *str.count( < string >+ )* → *int*

Each *string* parameter defines a set of characters to count. The intersection of these sets defines the characters to count in *str*. Any parameter that starts with a caret (^) is negated. The sequence *c*<sub>1</sub>–*c*<sub>2</sub> means all characters between *c*<sub>1</sub> and *c*<sub>2</sub>.

```

a = "hello world"
a.count "lo" → 5
a.count "lo", "o" → 2
a.count "hello", "^l" → 4
a.count "ej-m" → 4

```

---

**crypt** *str.crypt( settings )* → *string*

Applies a one-way cryptographic hash to *str* by invoking the standard library function `crypt`. The argument is to some extent system dependent. On traditional Unix boxes, it is often a two-character *salt* string. On more modern boxes, it may also control things such as DES encryption parameters. See the man page for `crypt(3)` for details.

```

standard salt
"secret".crypt("sh") → "shRK3aVg8FsI2"
On OSX: DES, 2 interactions, 24-bit salt
"secret".crypt("_...0abcd") → "_...0abcdR0n65JNDj12"

```

---

**delete** *str.delete( < string >+ )* → *new\_string*

Returns a copy of *str* with all characters in the intersection of its arguments deleted. Uses the same rules for building the set of characters as `String#count`.

```

"hello".delete("l", "lo") → "heo"
"hello".delete("lo") → "he"
"hello".delete("aeiou", "^e") → "hell"
"hello".delete("ej-m") → "ho"

```

---

**delete!** *str.delete!( < string >+ ) → str or nil*

---

Performs a delete operation in place, returning *str*, or returning `nil` if *str* was not modified.

```
a = "hello"
a.delete!("l","lo") → "heo"
a → "heo"
a.delete!("l") → nil
```

---

**downcase** *str.downcase → string*

---

Returns a copy of *str* with all uppercase letters replaced with their lowercase counterparts. The operation is locale insensitive—only characters *A* to *Z* are affected. Multibyte characters are skipped.

```
"hEllo".downcase → "hello"
```

---

**downcase!** *str.downcase! → str or nil*

---

Replace uppercase letters in *str* with their lowercase counterparts, returning `nil` if no changes were made.

---

**dump** *str.dump → string*

---

Produces a version of *str* with all nonprinting characters replaced by `\nnn` notation and all special characters escaped.

---

**each** *str.each( sep=\$/ ) { | substr | block } → str*

---

Splits *str* using the supplied parameter as the record separator (`$/` by default), passing each substring in turn to the supplied block. If a zero-length record separator is supplied, the string is split into paragraphs, each terminated by multiple `\n` characters.

```
print "Example one\n"
"hello\nworld".each { |s| p s }
print "Example two\n"
"hello\nworld".each('l') { |s| p s }
print "Example three\n"
"hello\n\nworld".each('') { |s| p s }
```

*produces:*

```
Example one
"hello\n"
"world"
Example two
"hel"
"l"
"o\nworl"
"d"
Example three
"hello\n\n\n"
"world"
```

---

**each\_byte** *str*.each\_byte { |int| block } → *str*

---

Passes each byte in *str* to the given block.

```
"hello".each_byte { |c| print c, ' ' }
```

produces:

```
104 101 108 108 111
```

---

**each\_line** *str*.each\_line( *sep*=\$/ ) { |substr| block } → *str*

---

Synonym for String#each.

---

**empty?** *str*.empty? → true or false

---

Returns true if *str* has a length of zero.

```
"hello".empty? → false
```

```
"".empty? → true
```

---

**eql?** *str*.eql?( *obj* ) → true or false

---

Returns true if *obj* is a String with identical contents to *str*.

```
"cat".eql?("cat") → true
```

---

**gsub** *str*.gsub( *pattern*, *replacement* ) → *string*  
*str*.gsub( *pattern* ) { |match| block } → *string*

---

Returns a copy of *str* with *all* occurrences of *pattern* replaced with either *replacement* or the value of the block. The *pattern* will typically be a Regexp; if it is a String then no regular expression metacharacters will be interpreted (that is `/\d/` will match a digit, but `'\d'` will match a backslash followed by a *d*).

If a string is used as the replacement, special variables from the match (such as `$&` and `$1`) cannot be substituted into it, as substitution into the string occurs before the pattern match starts. However, the sequences `\1`, `\2`, and so on may be used to interpolate successive groups in the match. These sequences are shown in Table 27.13 on the following page.

In the block form, the current match is passed in as a parameter, and variables such as `$1`, `$2`, `$``, `$&`, and `$'` will be set appropriately. The value returned by the block will be substituted for the match on each call.

The result inherits any tainting in the original string or any supplied replacement string.

```
"hello".gsub(/[aeiou]/, '*') → "h*ll*"
"hello".gsub(/[aeiou]/, '<\1>') → "h<e>ll<o>"
"hello".gsub(/./) { |s| s[0].to_s + ' ' } → "104 101 108 108 111 "
```

---

Table 27.13. Backslash sequences in substitution strings

Sequence	Text That Is Substituted
<code>\1, \2, ... \9</code>	The value matched by the <i>n</i> th grouped subexpression
<code>&amp;</code>	The last match
<code>`</code>	The part of the string before the match
<code>'</code>	The part of the string after the match
<code>\+</code>	The highest-numbered group matched

---

**gsub!** *str.gsub!( pattern, replacement )* → *str* or *nil*  
*str.gsub!( pattern ) { |match| block }* → *str* or *nil*

---

Performs the substitutions of `String#gsub` in place, returning *str*, or returning *nil* if no substitutions were performed.

---

**hex** *str.hex* → *int*

---

Treats leading characters from *str* as a string of hexadecimal digits (with an optional sign and an optional 0x), and returns the corresponding number. Zero is returned on error.

```
"0x0a".hex → 10
"-1234".hex → -4660
"0".hex → 0
"wombat".hex → 0
```

---

**include?** *str.include?( string )* → true or false  
*str.include?( int )* → true or false

---

Returns true if *str* contains the given string or character.

```
"hello".include? "lo" → true
"hello".include? "ol" → false
"hello".include? ?h → true
```

---

**index** *str.index( string <, offset > )* → *int* or *nil*  
*str.index( int <, offset > )* → *int* or *nil*  
*str.index( regexp <, offset > )* → *int* or *nil*

---

Returns the index of the first occurrence of the given substring, character, or pattern in *str*. Returns *nil* if not found. If the second parameter is present, it specifies the position in the string to begin the search.

```
"hello".index('e') → 1
"hello".index('lo') → 3
"hello".index('a') → nil
"hello".index(101) → 1
"hello".index(/[aeiou]/, -3) → 4
```

---

**insert** *str.insert(index, string) → str*

---

1.8 Inserts *string* before the character at the given *index*, modifying *str*. Negative indices count from the end of the string and insert *after* the given character. After the insertion, *str* will contain *string* starting at *index*.

```
"abcd".insert(0, 'X') → "Xabcd"
"abcd".insert(3, 'X') → "abcXd"
"abcd".insert(4, 'X') → "abcdX"
"abcd".insert(-3, 'X') → "abXcd"
"abcd".insert(-1, 'X') → "abcdX"
```

---

**intern** *str.intern → symbol*

---

1.8 Returns the Symbol corresponding to *str*, creating the symbol if it did not previously exist. Can intern any string, not just identifiers. See Symbol#id2name on page 610.

```
"Koala".intern → :Koala
sym = "$1.50 for a soda!?!?".intern
sym.to_s → "$1.50 for a soda!?!?"
```

---

**length** *str.length → int*

---

Returns the length of *str*.

---

**ljust** *str.ljust(width, padding=" ") → string*

---

1.8 If *width* is greater than the length of *str*, returns a new String of length *width* with *str* left justified and padded with copies of *padding*; otherwise, returns a copy of *str*.

```
"hello".ljust(4) → "hello"
"hello".ljust(20) → "hello_ "
"hello".ljust(20, "*") → "hello*****"
"hello".ljust(20, " dolly") → "hello_dolly_dolly_do"
```

---

**lstrip** *str.lstrip → string*

---

1.8 Returns a copy of *str* with leading whitespace characters removed. Also see the methods String#rstrip and String#strip.

```
" hello ".lstrip → "hello_"
"\000 hello ".lstrip → "\000_hello_"
"hello".lstrip → "hello"
```

---

**rstrip!** *str.rstrip! → self or nil*

---

1.8 Removes leading whitespace characters from *str*, returning nil if no change was made. See also String#rstrip! and String#strip!.

```
" hello ".rstrip! → "hello_"
"hello".rstrip! → nil
```

---

**match** *str.match( pattern )* → *match\_data* or *nil*

---

1.8 Converts *pattern* to a Regexp (if it isn't already one), and then invokes its `match` method on *str*.

```
'hello'.match('(.)\1') → #<MatchData:0x1c9468>
'hello'.match('(.)\1')[0] → "ll"
'hello'.match(/(.)\1/)[0] → "ll"
'hello'.match('xx') → nil
```

---

**next** *str.next* → *string*

---

Synonym for `String#succ`.

---

**next!** *str.next!* → *str*

---

Synonym for `String#succ!`.

---

**oct** *str.oct* → *int*

---

Treats leading characters of *str* as a string of octal digits (with an optional sign), and returns the corresponding number. Returns 0 if the conversion fails.

```
"123".oct → 83
"-377".oct → -255
"bad".oct → 0
"0377bad".oct → 255
```

---

**replace** *str.replace( string )* → *str*

---

Replaces the contents and taintedness of *str* with the corresponding values in *string*.

```
s = "hello" → "hello"
s.replace "world" → "world"
```

---

**reverse** *str.reverse* → *string*

---

Returns a new string with the characters from *str* in reverse order.

```
Every problem contains its own solution...
"stressed".reverse → "desserts"
```

---

**reverse!** *str.reverse!* → *str*

---

Reverses *str* in place.

---

**rindex** *str.rindex( string < , int > )* → *int* or *nil*  
*str.rindex( int < , int > )* → *int* or *nil*  
*str.rindex( regexp < , int > )* → *int* or *nil*

---

Returns the index of the last occurrence of the given substring, character, or pattern in *str*. Returns `nil` if not found. If the second parameter is present, it specifies the position in the string to end the search—characters beyond this point will not be considered.

```

"hello".rindex('e') → 1
"hello".rindex('l') → 3
"hello".rindex('a') → nil
"hello".rindex(101) → 1
"hello".rindex(/[aeiou]/, -2) → 1

```

---

**rjust** *str.rjust( width, padding="" ) → string*

1.8

If *width* is greater than the length of *str*, returns a new String of length *width* with *str* right justified and padded with copies of *padding*; otherwise, returns a copy of *str*.

```

"hello".rjust(4) → "hello"
"hello".rjust(20) → "_____hello"
"hello".rjust(20, "-") → "-----hello"
"hello".rjust(20, "padding") → "paddingpaddinghello"

```

---

**rstrip** *str.rstrip → string*

1.8

Returns a copy of *str*, stripping first trailing NUL characters and then stripping trailing whitespace characters. See also `String#lstrip` and `String#strip`.

```

" hello ".rstrip → " _hello"
" hello \000 ".rstrip → " _hello_\000"
" hello \000".rstrip → " _hello"
"hello".rstrip → "hello"

```

---

**rstrip!** *str.rstrip! → self or nil*

1.8

Removes trailing NUL characters and then removes trailing whitespace characters from *str*. Returns `nil` if no change was made. See also `String#lstrip!` and `#strip!`.

```

" hello ".rstrip! → " _hello"
"hello".rstrip! → nil

```

---

**scan** *str.scan( pattern ) → array*  
*str.scan( pattern ) { |match, ... | block } → str*

Both forms iterate through *str*, matching the pattern (which may be a Regexp or a String). For each match, a result is generated and either added to the result array or passed to the block. If the pattern contains no groups, each individual result consists of the matched string, `$&`. If the pattern contains groups, each individual result is itself an array containing one entry per group. If the pattern is a String, it is interpreted literally (i.e., it is not taken to be a regular expression pattern).

```

a = "cruel world"
a.scan(/\w+/) → ["cruel", "world"]
a.scan(/.../) → ["cru", "el ", "wor"]
a.scan(/(...)/) → [["cru"], ["el "], ["wor"]]
a.scan(/(..)(..)/) → [{"cr", "ue"}, {"l ", "wo"}]

```

And the block form



```

a.scan(/\w+/) {|w| print "<<#{w}>> " }
puts
a.scan/(.)(.)/ {|a,b| print b, a }
puts

```

*produces:*

```

<<cruel>> <<world>>
rceu lowlr

```

---

**size** *str.size* → *int*

---

Synonym for `String#length`.

---

**slice** *str.slice( int )* → *int* or *nil*  
*str.slice( int, int )* → *string* or *nil*  
*str.slice( range )* → *string* or *nil*  
*str.slice( regexp )* → *string* or *nil*  
*str.slice( match\_string )* → *string* or *nil*

---

Synonym for `String#[ ]`.

```

a = "hello there"
a.slice(1) → 101
a.slice(1,3) → "ell"
a.slice(1..3) → "ell"
a.slice(-3,2) → "er"
a.slice(-4..-2) → "her"

a.slice(-2..-4) → ""
a.slice(/th[aeiou]/) → "the"
a.slice("lo") → "lo"
a.slice("bye") → nil

```

---

**slice!** *str.slice!( int )* → *int* or *nil*  
*str.slice!( int, int )* → *string* or *nil*  
*str.slice!( range )* → *string* or *nil*  
*str.slice!( regexp )* → *string* or *nil*  
*str.slice!( match\_string )* → *string* or *nil*

---

Deletes the specified portion from *str*, and returns the portion deleted. The forms that take a Fixnum will raise an `IndexError` if the value is out of range; the Range form will raise a `RangeError`, and the Regexp and String forms will silently not change the string.

```

string = "this is a string"
string.slice!(2) → 105
string.slice!(3..6) → " is "
string.slice!(/s.*t/) → "sa st"
string.slice!("r") → "r"
string → "thing"

```

**split***str.split(pattern=\$;, <limit>) → array*

Divides *str* into substrings based on a delimiter, returning an array of these substrings.

If *pattern* is a String, then its contents are used as the delimiter when splitting *str*. If *pattern* is a single space, *str* is split on whitespace, with leading whitespace and runs of contiguous whitespace characters ignored.

If *pattern* is a Regexp, *str* is divided where the pattern matches. Whenever the pattern matches a zero-length string, *str* is split into individual characters. If *pattern* includes groups, these groups will be included in the returned values.

If *pattern* is omitted, the value of `$;` is used. If `$;` is `nil` (which is the default), *str* is split on whitespace as if “`_`” were specified.

If the *limit* parameter is omitted, trailing empty fields are suppressed. If *limit* is a positive number, at most that number of fields will be returned (if *limit* is 1, the entire string is returned as the only entry in an array). If negative, there is no limit to the number of fields returned, and trailing null fields are not suppressed.

```

"now's the time".split → ["now's", "the", "time"]
"now's the time".split(' ') → ["now's", "the", "time"]
"now's the time".split(/ /) → ["", "now's", "", "", "the",
 "time"]

"a@1bb@2ccc".split(/@/d/) → ["a", "bb", "ccc"]
"a@1bb@2ccc".split(/@(\d)/) → ["a", "1", "bb", "2", "ccc"]
"1, 2.34,56, 7".split(/,\s*/) → ["1", "2.34", "56", "7"]
"hello".split(//) → ["h", "e", "l", "l", "o"]
"hello".split(//, 3) → ["h", "e", "llo"]
"hi mom".split(/,\s*/) → ["h", "i", "m", "o", "m"]

"".split → []

"mellow yellow".split("ello") → ["m", "w y", "w"]
"1,2,,3,4,,".split(',') → ["1", "2", "", "3", "4"]
"1,2,,3,4,,".split(',', 4) → ["1", "2", "", "3,4,,"]
"1,2,,3,4,,".split(',', -4) → ["1", "2", "", "3", "4", "", ""]

```

**squeeze***str.squeeze(<string>\*) → squeezed\_string*

Builds a set of characters from the *string* parameter(s) using the procedure described for `String#count` on page 590. Returns a new string where runs of the same character that occur in this set are replaced by a single character. If no arguments are given, all runs of identical characters are replaced by a single character.

```

"yellow moon".squeeze → "yelow mon"
"now is the".squeeze(" ") → "now is the"
"putters putt balls".squeeze("m-z") → "putters put balls"

```

---

**squeeze!** *str.squeeze!( < string >\* ) → str or nil*

---

Squeezes *str* in place, returning *str*. Returns `nil` if no changes were made.

---

**strip** *str.strip → string*

---

1.8

Returns a copy of *str* with leading whitespace and trailing NUL and whitespace characters removed.

```
" hello ".strip → "hello"
"\tgoodbye\r\n".strip → "goodbye"
"goodbye \000".strip → "goodbye"
"goodbye \000 ".strip → "goodbye \000"
```

---

**strip!** *str.strip! → str or nil*

---

1.8

Removes leading whitespace and trailing NUL and whitespace characters removed from *str*. Returns `nil` if *str* was not altered.

---

**sub** *str.sub( pattern, replacement ) → string*

---

*str.sub( pattern ) { |match| block } → string*

Returns a copy of *str* with the *first* occurrence of *pattern* replaced with either *replacement* or the value of the block. The *pattern* will typically be a Regexp; if it is a String then no regular expression metacharacters will be interpreted (that is `/\d/` will match a digit, but `'\d'` will match a backslash followed by a *d*).

If the method call specifies *replacement*, special variables such as `$$` will not be useful, as substitution into the string occurs before the pattern match starts. However, the sequences `\1`, `\2`, listed in Table 27.13 on page 593 may be used.

In the block form, the current match is passed in as a parameter, and variables such as `$1`, `$2`, `$``, `$$`, and `$'` will be set appropriately. The value returned by the block will be substituted for the match on each call.

```
"hello".sub(/[aeiou]/, '*') → "h*llo"
"hello".sub(/([aeiou])/, '<\1>') → "h<e>llo"
"hello".sub(/./) { |s| s[0].to_s + ' ' } → "104 ello"
```

---

**sub!** *str.sub!( pattern, replacement ) → str or nil*

---

*str.sub!( pattern ) { |match| block } → str or nil*

Performs the substitutions of `String#sub` in place, returning *str*. Returns `nil` if no substitutions were performed.

---

**succ** *str.succ → string*

---

Returns the successor to *str*. The successor is calculated by incrementing characters starting from the rightmost alphanumeric (or the rightmost character if there are no alphanumerics) in the string. Incrementing a digit always results in another digit, and

incrementing a letter results in another letter of the same case. Incrementing nonalphanumerics uses the underlying character set's collating sequence.

If the increment generates a “carry,” the character to the left of it is incremented. This process repeats until there is no carry, adding an additional character if necessary.

```
"abcd".succ → "abce"
"THX1138".succ → "THX1139"
"<<koala>>".succ → "<<koalb>>"
"1999zzz".succ → "2000aaa"
"ZZZ9999".succ → "AAAA0000"
"***".succ → "***"
```

---

**succ!** *str.succ! → str*

---

Equivalent to `String#succ`, but modifies the receiver in place.

---

**sum** *str.sum( n=16 ) → int*

---

1.8

Returns a basic  $n$ -bit checksum of the characters in *str*, where  $n$  is the optional parameter, defaulting to 16. The result is simply the sum of the binary value of each character in *str* modulo  $2^n - 1$ . This is not a particularly good checksum—see the digest libraries on page 647 for better alternatives.

```
"now is the time".sum → 1408
"now is the time".sum(8) → 128
```

---

**swapcase** *str.swapcase → string*

---

Returns a copy of *str* with uppercase alphabetic characters converted to lowercase and lowercase characters converted to uppercase.

```
"Hello".swapcase → "hELLO"
"cyBEr_PuNk11".swapcase → "CyBeR_pUnK11"
```

---

**swapcase!** *str.swapcase! → str or nil*

---

Equivalent to `String#swapcase`, but modifies *str* in place, returning *str*. Returns `nil` if no changes were made.

---

**to\_f** *str.to\_f → float*

---

Returns the result of interpreting leading characters in *str* as a floating-point number. Extraneous characters past the end of a valid number are ignored. If there is not a valid number at the start of *str*, 0.0 is returned. The method never raises an exception (use `Kernel.Float` to validate numbers).

```
"123.45e1".to_f → 1234.5
"45.67 degrees".to_f → 45.67
"thx1138".to_f → 0.0
```

---

**to\_i** *str.to\_i( base=10 ) → int*

---

1.8

Returns the result of interpreting leading characters in *str* as an integer base *base* (2 to 36). Given a base of zero, `to_i` looks for leading 0, 0b, 0o, 0d, or 0x and sets the base accordingly. Leading spaces are ignored, and leading plus or minus signs are honored. Extraneous characters past the end of a valid number are ignored. If there is not a valid number at the start of *str*, 0 is returned. The method never raises an exception.

```
"12345".to_i → 12345
"99 red balloons".to_i → 99
"0a".to_i → 0
"0a".to_i(16) → 10
"0x10".to_i → 0
"0x10".to_i(0) → 16
"-0x10".to_i(0) → -16
"hello".to_i → 0
"hello".to_i(30) → 14167554
"1100101".to_i(2) → 101
"1100101".to_i(8) → 294977
"1100101".to_i(10) → 1100101
"1100101".to_i(16) → 17826049
"1100101".to_i(24) → 199066177
```

---

**to\_s** *str.to\_s → str*

---

Returns the receiver.

---

**to\_str** *str.to\_str → str*

---

Synonym for `String#to_s`. `to_str` is used by methods such as `String#concat` to convert their arguments to a string. Unlike `to_s`, which is supported by almost all classes, `to_str` is normally implemented only by those classes that act like strings. Of the built-in classes, only `Exception` and `String` implement `to_str`.

---

**to\_sym** *str.to\_s → symbol*

---

Returns the symbol for *str*. This can create symbols that cannot be represented using the `:xxx` notation.

```
s = 'cat'.to_sym → :cat
s == :cat → true
s = '@cat'.to_sym → :@cat
s == :@cat → true
'cat and dog'.to_sym → :"cat and dog"
s == :'cat and dog' → false
```

---

**tr** *str.tr( from\_string, to\_string ) → string*

---

Returns a copy of *str* with the characters in *from\_string* replaced by the corresponding characters in *to\_string*. If *to\_string* is shorter than *from\_string*, it is padded with its last character. Both strings may use the  $c_1$ – $c_2$  notation to denote ranges of characters, and *from\_string* may start with a  $\wedge$ , which denotes all characters except those listed.

```
"hello".tr('aeiou', '*') → "h*ll*"
"hello".tr('^aeiou', '*') → "*e**o"
"hello".tr('el', 'ip') → "hippo"
"hello".tr('a-y', 'b-z') → "ifmmp"
```

---

**tr!** *str.tr!(from\_string, to\_string) → str or nil*

---

Translates *str* in place, using the same rules as `String#tr`. Returns *str*, or returns `nil` if no changes were made.

---

**tr\_s** *str.tr\_s(from\_string, to\_string) → string*

---

Processes a copy of *str* as described under `String#tr`, and then removes duplicate characters in regions that were affected by the translation.

```
"hello".tr_s('l', 'r') → "hero"
"hello".tr_s('el', '*') → "h*o"
"hello".tr_s('el', 'hx') → "hhxo"
```

---

**tr\_s!** *str.tr\_s!(from\_string, to\_string) → str or nil*

---

Performs `String#tr_s` processing on *str* in place, returning *str*. Returns `nil` if no changes were made.

---

**unpack** *str.unpack(format) → array*

---

Decodes *str* (which may contain binary data) according to the format string, returning an array of the extracted values. The format string consists of a sequence of single-character directives, summarized in Table 27.14 on the next page. Each directive may be followed by a number, indicating the number of times to repeat this directive. An asterisk (\*) will use up all remaining elements. The directives `sSiILl` may each be followed by an underscore (\_) to use the underlying platform's native size for the specified type; otherwise, it uses a platform-independent consistent size. Spaces are ignored in the format string. Comments starting with # to the next newline or end of string are also ignored. See also `Array#pack` on page 415.

1.8

```
"abc \0\0abc \0\0".unpack('A6Z6') → ["abc", "abc "]
"abc \0\0".unpack('a3a3') → ["abc", " \000\000"]
"aa".unpack('b8B8') → ["10000110", "01100001"]
"aaa".unpack('h2H2c') → ["16", "61", 97]
"\xfe\xff\xfe\xff".unpack('sS') → [-257, 65279]
"now=20is".unpack('M*') → ["now is"]
"whole".unpack('xax2aX2aX1aX2a') → ["h", "e", "l", "l", "o"]
```

---

**upcase** *str.upcase → string*

---

Returns a copy of *str* with all lowercase letters replaced with their uppercase counterparts. The operation is locale insensitive—only characters *a* to *z* are affected.

```
"hEllo".upcase → "HELLO"
```

Table 27.14. Directives for String#unpack

Format	Function	Returns
A	String with trailing NULs and spaces removed.	String
a	String.	String
B	Extract bits from each character (MSB first).	String
b	Extract bits from each character (LSB first).	String
C	Extract a character as an unsigned integer.	Fixnum
c	Extract a character as an integer.	Fixnum
d,D	Treat <i>sizeof(double)</i> characters as a native double.	Float
E	Treat <i>sizeof(double)</i> characters as a double in little-endian byte order.	Float
e	Treat <i>sizeof(float)</i> characters as a float in little-endian byte order.	Float
f,F	Treat <i>sizeof(float)</i> characters as a native float.	Float
G	Treat <i>sizeof(double)</i> characters as a double in network byte order.	Float
g	Treat <i>sizeof(float)</i> characters as a float in network byte order.	Float
H	Extract hex nibbles from each character (most significant first).	String
h	Extract hex nibbles from each character (least significant first).	String
I	Treat <i>sizeof(int)</i> <sup>1</sup> successive characters as an unsigned native integer.	Integer
i	Treat <i>sizeof(int)</i> <sup>1</sup> successive characters as a signed native integer.	Integer
L	Treat four <sup>1</sup> successive characters as an unsigned native long integer.	Integer
l	Treat four <sup>1</sup> successive characters as a signed native long integer.	Integer
M	Extract a quoted-printable string.	String
m	Extract a Base64 encoded string.	String
N	Treat four characters as an unsigned long in network byte order.	Fixnum
n	Treat two characters as an unsigned short in network byte order.	Fixnum
P	Treat <i>sizeof(char *)</i> characters as a pointer, and return <i>len</i> characters from the referenced location.	String
p	Treat <i>sizeof(char *)</i> characters as a pointer to a null-terminated string.	String
Q	Treat eight characters as an unsigned quad word (64 bits).	Integer
q	Treat eight characters as a signed quad word (64 bits).	Integer
S	Treat two <sup>1</sup> successive characters as an unsigned short in native byte order.	Fixnum
s	Treat two <sup>1</sup> successive characters as a signed short in native byte order.	Fixnum
U	Extract UTF-8 characters as unsigned integers.	Integer
u	Extract a UU-encoded string.	String
V	Treat four characters as an unsigned long in little-endian byte order.	Fixnum
v	Treat two characters as an unsigned short in little-endian byte order.	Fixnum
w	BER-compressed integer (see Array#pack for more information).	Integer
X	Skip backward one character.	—
x	Skip forward one character.	—
Z	String with trailing NULs removed.	String
@	Skip to the offset given by the length argument.	—

<sup>1</sup> May be modified by appending “\_” to the directive.

---

**uppercase!** *str.upcase!* → *str* or *nil*

---

Uppcases the contents of *str*, returning *nil* if no changes were made.

---

**upto** *str.upto( string ) { |s| block } → str*

---

Iterates through successive values, starting at *str* and ending at *string* inclusive, passing each value in turn to the block. The `String#succ` method is used to generate each value.

```
"a8".upto("b6") { |s| print s, ' ' }
for s in "a8".."b6"
 print s, ' '
end
```

*produces:*

```
a8 a9 b0 b1 b2 b3 b4 b5 b6
a8 a9 b0 b1 b2 b3 b4 b5 b6
```



**Class** **Struct** < Object

Subclasses: Struct::Tms

A `Struct` is a convenient way to bundle a number of attributes together, using accessor methods, without having to write an explicit class.

The `Struct` class is a generator of specific classes, each one of which is defined to hold a set of variables and their accessors. In these examples, we'll call the generated class *Customer*, and we'll show an example instance of that class as *joe*.

Also see `OpenStruct` on page 689.

In the descriptions that follow, the parameter *symbol* refers to a symbol, which is either a quoted string or a `Symbol` (such as `:name`).

**Mixes in****Enumerable:**

`all?`, `any?`, `collect`, `detect`, `each_with_index`, `entries`, `find`, `find_all`,  
`grep`, `include?`, `inject`, `map`, `max`, `member?`, `min`, `partition`, `reject`,  
`select`, `sort`, `sort_by`, `to_a`, `zip`

**Class methods**

**new** `Struct.new( < string > < , symbol >+ ) → Customer`  
[1.9] `Struct.new( < string > < , symbol >+ ) { block } → Customer`

Creates a new class, named by *string*, containing accessor methods for the given symbols. If the name *string* is omitted, an anonymous structure class will be created. Otherwise, the name of this struct will appear as a constant in class `Struct`, so it must be unique for all `Struct`s in the system and should start with a capital letter. Assigning a structure class to a constant effectively gives the class the name of the constant.

`Struct.new` returns a new `Class` object, which can then be used to create specific instances of the new structure. The remaining methods listed below (class and instance) are defined for this generated class. See the description that follows for an example.

Ruby 1.9 and later allow you to pass a block to a `Struct`'s constructor. This block is evaluated in the context of the new struct's class and hence allows you conveniently to add instance methods to the new struct.

```
Create a structure with a name in Struct
Struct.new("Customer", :name, :address) → Struct::Customer
Struct::Customer.new("Dave", "123 Main") → #<struct
 Struct::Customer
 name="Dave",
 address="123 Main">
```

```
Create a structure named by its constant
Customer = Struct.new(:name, :address) → Customer
Customer.new("Dave", "123 Main") → #<struct Customer
 name="Dave", address="123
 Main">
```

---

**new** *Customer.new( <obj>+ ) → joe*

---

Creates a new instance of a structure (the class created by `Struct.new`). The number of actual parameters must be less than or equal to the number of attributes defined for this class; unset parameters default to `nil`. Passing too many parameters will raise an `ArgumentError`.

```
Customer = Struct.new(:name, :address, :zip)

joe = Customer.new("Joe Smith", "123 Maple, Anytown NC", 12345)
joe.name → "Joe Smith"
joe.zip → 12345
```

---

**[]** *Customer[ <obj>+ ] → joe*

---

Synonym for `new` (for the generated structure).

```
Customer = Struct.new(:name, :address, :zip)

joe = Customer["Joe Smith", "123 Maple, Anytown NC", 12345]
joe.name → "Joe Smith"
joe.zip → 12345
```

---

**members** *Customer.members → array*

---

Returns an array of strings representing the names of the instance variables.

```
Customer = Struct.new("Customer", :name, :address, :zip)
Customer.members → ["name", "address", "zip"]
```

## Instance methods

---

**==** *joe == other\_struct → true or false*

---

Equality—Returns true if *other\_struct* is equal to this one: they must be of the same class as generated by `Struct.new`, and the values of all instance variables must be equal (according to `Object#==`).

```
Customer = Struct.new(:name, :address, :zip)

joe = Customer.new("Joe Smith", "123 Maple, Anytown NC", 12345)
joejr = Customer.new("Joe Smith", "123 Maple, Anytown NC", 12345)
jane = Customer.new("Jane Doe", "456 Elm, Anytown NC", 12345)

joe == joejr → true
joe == jane → false
```

---

**[ ]** *joe[ symbol ] → obj*  
*joe[ integer ] → obj*

---

Attribute Reference—Returns the value of the instance variable named by *symbol* or indexed ( $0.length - 1$ ) by *int*. Raises `NameError` if the named variable does not exist, or raises `IndexError` if the index is out of range.

```
Customer = Struct.new(:name, :address, :zip)
joe = Customer.new("Joe Smith", "123 Maple, Anytown NC", 12345)
joe["name"] → "Joe Smith"
joe[:name] → "Joe Smith"
joe[0] → "Joe Smith"
```

---

**[ ]=** *joe[ symbol ] = obj → obj*  
*joe[ int ] = obj → obj*

---

Attribute Assignment—Assigns to the instance variable named by *symbol* or *int* the value *obj* and returns it. Raises a `NameError` if the named variable does not exist, or raises an `IndexError` if the index is out of range.

```
Customer = Struct.new(:name, :address, :zip)
joe = Customer.new("Joe Smith", "123 Maple, Anytown NC", 12345)
joe["name"] = "Luke"
joe[:zip] = "90210"
joe.name → "Luke"
joe.zip → "90210"
```

---

**each** *joe.each { |obj| block } → joe*

---

Calls *block* once for each instance variable, passing the value as a parameter.

```
Customer = Struct.new(:name, :address, :zip)
joe = Customer.new("Joe Smith", "123 Maple, Anytown NC", 12345)
joe.each { |x| puts(x) }
```

*produces:*

```
Joe Smith
123 Maple, Anytown NC
12345
```

---

**each\_pair** *joe.each\_pair { |symbol, obj| block } → joe*

---

1.8 Calls *block* once for each instance variable, passing the name (as a symbol) and the value as parameters.

```
Customer = Struct.new(:name, :address, :zip)
joe = Customer.new("Joe Smith", "123 Maple, Anytown NC", 12345)
joe.each_pair { |name, value| puts("#{name} => #{value}") }
```

*produces:*

```
name => Joe Smith
address => 123 Maple, Anytown NC
zip => 12345
```

---

**length** *joe.length* → *int*

---

Returns the number of instance variables.

```
Customer = Struct.new(:name, :address, :zip)
joe = Customer.new("Joe Smith", "123 Maple, Anytown NC", 12345)
joe.length → 3
```

---

**members** *joe.members* → *array*

---

Returns an array of strings representing the names of the instance variables.

```
Customer = Struct.new(:name, :address, :zip)
joe = Customer.new("Joe Smith", "123 Maple, Anytown NC", 12345)
joe.members → ["name", "address", "zip"]
```

---

**size** *joe.size* → *int*

---

Synonym for Struct#length.

---

**to\_a** *joe.to\_a* → *array*

---

Returns the values for this instance as an array.

```
Customer = Struct.new(:name, :address, :zip)
joe = Customer.new("Joe Smith", "123 Maple, Anytown NC", 12345)
joe.to_a[1] → "123 Maple, Anytown NC"
```

---

**values** *joe.values* → *array*

---

Synonym for to\_a.

---

**values\_at** *joe.values\_at*( < *selector* )\* ) → *array*

---

1.8 Returns an array containing the elements in *joe* corresponding to the given indices. The selectors may be integer indices or ranges.

```
Lots = Struct.new(:a, :b, :c, :d, :e, :f)
l = Lots.new(11, 22, 33, 44, 55, 66)
l.values_at(1, 3, 5) → [22, 44, 66]
l.values_at(0, 2, 4) → [11, 33, 55]
l.values_at(-1, -3, -5) → [66, 44, 22]
```

**Class** **Struct::Tms** < Struct

This structure is returned by `Process.times`. It holds information on process times on those platforms that support it. Not all values are valid on all platforms. This structure contains the following instance variables and the corresponding accessors:

---

<code>utime</code>	Amount of user CPU time, in seconds
<code>stime</code>	Amount of system CPU time, in seconds
<code>cutime</code>	Total of completed child processes' user CPU time, in seconds (always 0 on Windows)
<code>cstime</code>	Total of completed child processes' system CPU time, in seconds (always 0 on Windows)

---

See also `Struct` on page [605](#) and `Process.times` on page [566](#).

```
def eat_cpu
 100_000.times { Math.sin(0.321) }
end
3.times { fork { eat_cpu } }
eat_cpu
Process.waitall
t = Process::times
[t.utime, t.stime] → [0.28, 0.03]
[t.cutime, t.cstime] → [0.74, 0.01]
```

**Class** **Symbol** < Object

Symbol objects represent names inside the Ruby interpreter. They are generated using the `:name` literal syntax and by using the various `to_sym` methods. The same Symbol object will be created for a given name string for the duration of a program's execution, regardless of the context or meaning of that name. Thus, if `Fred` is a constant in one context, a method in another, and a class in a third, the Symbol `:Fred` will be the same object in all three contexts.

```
module One
 class Fred
 end
 $f1 = :Fred
 end
module Two
 Fred = 1
 $f2 = :Fred
end
def Fred()
end
$f3 = :Fred
$f1.id → 2526478
$f2.id → 2526478
$f3.id → 2526478
```

**Class methods**

---

**all\_symbols** Symbol.all\_symbols → array

---

1.8 Returns an array of all the symbols currently in Ruby's symbol table.

```
Symbol.all_symbols.size → 913
Symbol.all_symbols[1,20] → [[:floor, :ARGV, :Binding, :symlink,
 :chown, :EOFError, :$, :String,
 :LOCK_SH, :setuid?, :$,
 :default_proc, :compact, :extend, :Tms,
 :getwd, :$, :ThreadGroup, :success?,
 :wait2]
```

**Instance methods**

---

**id2name** *sym*.id2name → string

---

1.8 Returns the string representation of *sym*. Prior to Ruby 1.8, symbols typically represented names; now they can be arbitrary strings.

```
:fred.id2name → "fred"
:"99 red balloons!".id2name → "99 red balloons!"
```

---

**inspect** *sym.inspect* → *string*

---

Returns the representation of *sym* as a symbol literal.

```
:fred.inspect → :fred
:"99 red balloons!".inspect → : "99 red balloons!"
```

---

**to\_i** *sym.to\_i* → *fixnum*

---

Returns an integer that is unique for each symbol within a particular execution of a program.

```
:fred.to_i → 9857
"fred".to_sym.to_i → 9857
```

---

**to\_int** *sym.to\_int* → *fixnum*

---

Synonym for `Symbol#to_i`. Allows symbols to have integer-like behavior.

---

**to\_s** *sym.to\_s* → *string*

---

Synonym for `Symbol#id2name`.

---

**to\_sym** *sym.to\_sym* → *sym*

---

Symbols are symbol-like!

**Class** Thread < Object

Thread encapsulates the behavior of a thread of execution, including the main thread of the Ruby script. See the tutorial in Chapter 11, beginning on page 127.

In the descriptions that follow, the parameter *symbol* refers to a symbol, which is either a quoted string or a Symbol (such as `:name`).

**Class methods**

---

**abort\_on\_exception** Thread.abort\_on\_exception → true or false

---

Returns the status of the global “abort on exception” condition. The default is false. When set to true, or if the global \$DEBUG flag is true (perhaps because the command line option `-d` was specified) all threads will abort (the process will `exit(0)`) if an exception is raised in any thread. See also `Thread.abort_on_exception=`.

---

**abort\_on\_exception=** Thread.abort\_on\_exception=*bool* → true or false

---

When set to true, all threads will abort if an exception is raised. Returns the new state.

```
Thread.abort_on_exception = true
t1 = Thread.new do
 puts "In new thread"
 raise "Exception from thread"
end
sleep(1)
puts "not reached"
```

*produces:*

```
In new thread
prog.rb:4: Exception from thread (RuntimeError)
from prog.rb:2:in `initialize'
from prog.rb:2:in `new'
from prog.rb:2
```

---

**critical** Thread.critical → true or false

---

Returns the status of the global “thread critical” condition.

---

**critical=** Thread.critical=*bool* → true or false

---

Sets the status of the global “thread critical” condition and returns it. When set to true, prohibits scheduling of any existing thread. Does not block new threads from being created and run. Certain thread operations (such as stopping or killing a thread, sleeping in the current thread, and raising an exception) may cause a thread to be scheduled even when in a critical section. `Thread.critical` is not intended for daily use: it is primarily there to support folks writing threading libraries.



---

**current** Thread.current → *thread*

---

Returns the currently executing thread.

```
Thread.current → #<Thread:0x1d5790 run>
```

---

**exit** Thread.exit

---

Terminates the currently running thread and schedules another thread to be run. If this thread is already marked to be killed, `exit` returns the `Thread`. If this is the main thread, or the last thread, `exit` the process.

---

**fork** Thread.fork { *block* } → *thread*

---

Synonym for `Thread.start`.

---

**kill** Thread.kill(*thread*)

---

Causes the given thread to exit (see `Thread.exit`).

```
count = 0
a = Thread.new { loop { count += 1 } }
sleep(0.1) → 0
Thread.kill(a) → #<Thread:0x1c947c dead>
count → 39410
a.alive? → false
```

---

**list** Thread.list → *array*

---

Returns an array of `Thread` objects for all threads that are either runnable or stopped.

```
Thread.new { sleep(200) }
Thread.new { 1000000.times {|i| i*i } }
Thread.new { Thread.stop }
Thread.list.each {|thr| p thr }
```

*produces:*

```
#<Thread:0x1c960c sleep>
#<Thread:0x1c9698 run>
#<Thread:0x1c96fc sleep>
#<Thread:0x1d5790 run>
```

---

**main** Thread.main → *thread*

---

Returns the main thread for the process.

```
Thread.main → #<Thread:0x1d5790 run>
```

---

**new** Thread.new( <*arg*\* > ) { |*args*| *block* } → *thread*

---

Creates and runs a new thread to execute the instructions given in `block`. Any arguments passed to `Thread.new` are passed into the block.

```
x = Thread.new { sleep 0.1; print "x"; print "y"; print "z" }
a = Thread.new { print "a"; print "b"; sleep 0.2; print "c" }
x.join; a.join # wait for threads to finish
```

*produces:*

```
abxyzc
```

---

**pass**
**Thread.pass**

---

Invokes the thread scheduler to pass execution to another thread.

```
a = Thread.new { print "a"; Thread.pass; print "b" }
b = Thread.new { print "x"; Thread.pass; print "y" }
a.join; b.join
```

*produces:*

```
axby
```

---

**start**
**Thread.start( < args >\* ) { | args | block } → thread**

---

Basically the same as `Thread.new`. However, if class `Thread` is subclassed, then calling `start` in that subclass will not invoke the subclass's `initialize` method.

---

**stop**
**Thread.stop**

---

Stops execution of the current thread, putting it into a “sleep” state, and schedules execution of another thread. Resets the “critical” condition to false.

```
a = Thread.new { print "a"; Thread.stop; print "c" }
Thread.pass
print "b"
a.run
a.join
```

*produces:*

```
abc
```

## Instance methods

---

**[ ]**
**thr[ symbol ] → obj or nil**

---

Attribute Reference—Returns the value of a thread-local variable, using either a symbol or a string name. If the specified variable does not exist, returns `nil`.

```
a = Thread.new { Thread.current["name"] = "A"; Thread.stop }
b = Thread.new { Thread.current[:name] = "B"; Thread.stop }
c = Thread.new { Thread.current["name"] = "C"; Thread.stop }
Thread.list.each { |x| puts "#{x.inspect}: #{x[:name]}" }
```

*produces:*

```
#<Thread:0x1c92b0 sleep>: C
#<Thread:0x1c9328 sleep>: B
#<Thread:0x1c93b4 sleep>: A
#<Thread:0x1d5790 run>:
```

**[ ]=** *thr[ symbol ] = obj* → *obj*

Attribute Assignment—Sets or creates the value of a thread-local variable, using either a symbol or a string. See also `Thread#[ ]`.

**abort\_on\_exception** *thr.abort\_on\_exception* → true or false

Returns the status of the thread-local “abort on exception” condition for *thr*. The default is false. See also `Thread.abort_on_exception=`.

**abort\_on\_exception=** *thr.abort\_on\_exception= true or false* → true or false

When set to true, causes all threads (including the main program) to abort if an exception is raised in *thr*. The process will effectively `exit(0)`.

**alive?** *thr.alive?* → true or false

Returns true if *thr* is running or sleeping.

```
thr = Thread.new { }
thr.join → #<Thread:0x1c96fc dead>
Thread.current.alive? → true
thr.alive? → false
```

**exit** *thr.exit* → *thr* or nil

Terminates *thr* and schedules another thread to be run. If this thread is already marked to be killed, `exit` returns the `Thread`. If this is the main thread, or the last thread, exits the process.

**group** *thr.group* → *thread\_group*

1.8 Returns the `ThreadGroup` owning *thr*, or nil.

```
thread = Thread.new { sleep 99 }
Thread.current.group.list → [#<Thread:0x1c9418 sleep>,
 #<Thread:0x1d5790 run>]

new_group = ThreadGroup.new
thread.group.list → [#<Thread:0x1c9418 sleep>,
 #<Thread:0x1d5790 run>]

new_group.add(thread)
thread.group.list → [#<Thread:0x1c9418 sleep>]
Thread.current.group.list → [#<Thread:0x1d5790 run>]
```

**join** *thr.join* → *thr*  
*thr.join( limit )* → *thr*

1.8 The calling thread will suspend execution and run *thr*. Does not return until *thr* exits or until *limit* seconds have passed. If the time limit expires, nil will be returned; otherwise *thr* is returned.

Any threads not joined will be killed when the main program exits. If *thr* had previously raised an exception and the `abort_on_exception` and `$DEBUG` flags are not set (so the exception has not yet been processed), it will be processed at this time.

```
a = Thread.new { print "a"; sleep(10); print "b"; print "c" }
x = Thread.new { print "x"; Thread.pass; print "y"; print "z" }
x.join # Let x thread finish, a will be killed on exit.
```

*produces:*

axyz

The following example illustrates the *limit* parameter.

```
y = Thread.new { 4.times { sleep 0.1; print "tick...\n" } }
print "Waiting\n" until y.join(0.15)
```

*produces:*

```
tick...
Waiting
tick...
Waiting
tick...
tick...
```

---

**keys** *thr.keys* → *array*

---

1.8 Returns an array of the names of the thread-local variables (as symbols).

```
thr = Thread.new do
 Thread.current[:cat] = 'meow'
 Thread.current["dog"] = 'woof'
end
thr.join → #<Thread:0x1c965c dead>
thr.keys → [:dog, :cat]
```

---

**key?** *thr.key?(symbol)* → *true* or *false*

---

Returns true if the given string (or symbol) exists as a thread-local variable.

```
me = Thread.current
me[:oliver] = "a"
me.key?(:oliver) → true
me.key?(:stanley) → false
```

---

**kill** *thr.kill*

---

Synonym for `Thread#exit`.

---

**priority** *thr.priority* → *int*

---

Returns the priority of *thr*. Default is zero; higher-priority threads will run before lower-priority threads.

```
Thread.current.priority → 0
```

---

**priority=** *thr.priority= int → thr*

---

Sets the priority of *thr* to *integer*. Higher-priority threads will run before lower-priority threads.

```
count1 = count2 = 0
a = Thread.new do
 loop { count1 += 1 }
end
a.priority = -1

b = Thread.new do
 loop { count2 += 1 }
end
b.priority = -2
sleep 1
Thread.critical = 1
count1 → 451372
count2 → 4514
```

---

**raise** *thr.raise*  
*thr.raise( message )*  
*thr.raise( exception <, message <, array >> )*

---

1.8 Raises an exception (see `Kernel.raise` on page 506 for details) from *thr*. The caller does not have to be *thr*.

```
Thread.abort_on_exception = true
a = Thread.new { sleep(200) }
a.raise("Gotcha")
```

*produces:*

```
prog.rb:3: Gotcha (RuntimeError)
from prog.rb:2:in `initialize'
from prog.rb:2:in `new'
from prog.rb:2
```

---

**run** *thr.run → thr*

---

Wakes up *thr*, making it eligible for scheduling. If not in a critical section, then invokes the scheduler.

```
a = Thread.new { puts "a"; Thread.stop; puts "c" }
Thread.pass
puts "Got here"
a.run
a.join
```

*produces:*

```
a
Got here
c
```

---

**safe\_level** *thr.safe\_level* → *int*

---

Returns the safe level in effect for *thr*. Setting thread-local safe levels can help when implementing sandboxes that run insecure code.

```
thr = Thread.new { $SAFE = 3; sleep }
Thread.current.safe_level → 0
thr.safe_level → 3
```

---

**status** *thr.status* → *string*, *false* or *nil*

---

Returns the status of *thr*: *sleep* if *thr* is sleeping or waiting on I/O, *run* if *thr* is executing, *aborting* if *thr* is aborting, *false* if *thr* terminated normally, and *nil* if *thr* terminated with an exception.

```
a = Thread.new { raise("die now") }
b = Thread.new { Thread.stop }
c = Thread.new { Thread.exit }
d = Thread.new { sleep }
Thread.critical = true
d.kill → #<Thread:0x1c8e00 aborting>
a.status → nil
b.status → "sleep"
c.status → false
d.status → "aborting"
Thread.current.status → "run"
```

---

**stop?** *thr.stop?* → *true* or *false*

---

Returns true if *thr* is dead or sleeping.

```
a = Thread.new { Thread.stop }
b = Thread.current
a.stop? → true
b.stop? → false
```

---

**terminate** *thr.terminate*

---

Synonym for `Thread#exit`.

---

**value** *thr.value* → *obj*

---

Waits for *thr* to complete (via `Thread#join`) and returns its value.

```
a = Thread.new { 2 + 2 }
a.value → 4
```

---

**wakeup** *thr.wakeup* → *thr*

---

Marks *thr* as eligible for scheduling (it may still remain blocked on I/O, however). Does not invoke the scheduler (see `Thread#run`).

**Class** ThreadGroup < Object

A ThreadGroup keeps track of a number of threads. A Thread can belong to only one ThreadGroup at a time; adding a thread to a group will remove it from its current group. Newly created threads belong to the group of the thread that created them.

**ThreadGroup constants**

`Default` Default thread group.

**Class methods**

**new** ThreadGroup.new → *thgrp*

Returns a newly created ThreadGroup. The group is initially empty.

**Instance methods**

**add** *thgrp.add(thread)* → *thgrp*

Adds the given thread to this group, removing it from any other group to which it may have previously belonged.

```
puts "Default group is #{ThreadGroup::Default.list}"
tg = ThreadGroup.new
t1 = Thread.new { sleep }
t2 = Thread.new { sleep }
puts "t1 is #{t1}, t2 is #{t2}"
tg.add(t1)
puts "Default group now #{ThreadGroup::Default.list}"
puts "tg group now #{tg.list}"
```

*produces:*

```
Default group is #<Thread:0x1d5790>
t1 is #<Thread:0x1c942c>, t2 is #<Thread:0x1c93c8>
Default group now #<Thread:0x1c93c8>#<Thread:0x1d5790>
tg group now #<Thread:0x1c942c>
```

**enclose** *thgrp.enclose* → *thgrp*

1.8 Prevents threads being removed from *thgrp*.

```
thread = Thread.new { sleep 99 }
group = ThreadGroup.new
group.add(thread)
group.enclose
ThreadGroup::Default.add(thread)
```

*produces:*

```
prog.rb:5:in `add': can't move from the enclosed thread group (ThreadError)
from prog.rb:5
```

---

**enclosed?** *thgrp*.enclose → true or false

---

1.8 Returns true if this thread group has been enclosed.

---

**freeze** *thgrp*.freeze

---

Stops new threads being added to or removed from *thgrp*.

---

**list** *thgrp*.list → array

---

Returns an array of all existing Thread objects that belong to this group.

ThreadGroup::Default.list → [#<Thread:0x1d5790 run>]



**Class** Time < Object

Time is an abstraction of dates and times. Time is stored internally as the number of seconds and microseconds since the *epoch*, January 1, 1970 00:00 UTC. On some operating systems, this offset is allowed to be negative. Also see the library modules Date and ParseDate, described on pages 644 and 692, respectively.

The Time class treats GMT (Greenwich Mean Time) and UTC (Coordinated Universal Time)<sup>3</sup> as equivalent. GMT is the older way of referring to these baseline times but persists in the names of calls on POSIX systems.

All times are stored with some number of microseconds. Be aware of this fact when comparing times with each other—times that are apparently equal when displayed may be different when compared.

**Mixes in****Comparable:**

<, <=, ==, >=, >, between?

**Class methods****at**Time.at(*time*) → *time*Time.at(*seconds* {, *microseconds*}) → *time*1.8

Creates a new time object with the value given by *time*, or the given number of *seconds* (and optional *microseconds*) from epoch. A nonportable feature allows the offset to be negative on some systems.

Time.at(0) → Wed Dec 31 18:00:00 CST 1969

Time.at(946702800) → Fri Dec 31 23:00:00 CST 1999

Time.at(-284061600) → Sat Dec 31 00:00:00 CST 1960

**gm**Time.gm(*year* {, *month*, *day*, *hour*; *min*, *sec*, *usec*}) → *time*Time.gm(*sec*, *min*, *hour*, *day*, *month*, *year*, *wday*, *yday*, *isdst*, *tz*) → *time*

Creates a time based on given values, interpreted as UTC (GMT). The year must be specified. Other values default to the minimum value for that field (and may be nil or omitted). Months may be specified by numbers from 1 to 12 or by the three-letter English month names. Hours are specified on a 24-hour clock (0..23). Raises an ArgumentError if any values are out of range. Will also accept ten arguments in the order output by Time#to\_a.

Time.gm(2000, "jan", 1, 20, 15, 1) → Sat Jan 01 20:15:01 UTC 2000

3. Yes, UTC really does stand for Coordinated Universal Time. There was a committee involved.

---

**local** Time.local( year < , month, day, hour, min, sec, usec > ) → time  
Time.local( sec, min, hour, day, month, year, wday, yday, isdst, tz ) → time

---

Same as `Time.gm`, but interprets the values in the local time zone. The first form can be used to construct a `Time` object given the result of a call to `ParseDate#parsedate` (described on page 692).

```
require 'parsedate'
Time.local(2000,"jan",1,20,15,1) → Sat Jan 01 20:15:01 CST 2000

res = ParseDate.parsedate("2000-01-01 20:15:01")
Time.local(*res) → Sat Jan 01 20:15:01 CST 2000
```

---

**mktime** Time.mktime( year, month, day, hour, min, sec, usec ) → time

---

Synonym for `Time.local`.

---

**new** Time.new → time

---

Returns a `Time` object initialized to the current system time. **Note:** The object created will be created using the resolution available on your system clock and so may include fractional seconds.

```
a = Time.new → Thu Aug 26 22:38:02 CDT 2004
b = Time.new → Thu Aug 26 22:38:02 CDT 2004
a == b → false
"%0.6f" % a.to_f → "1093577882.292375"
"%0.6f" % b.to_f → "1093577882.293183"
```

---

**now** Time.now → time

---

Synonym for `Time.new`.

---

**times** Time.times → struct\_tms

---

1.8 Deprecated in favor of `Process.times`, documented on page 566.

---

**utc** Time.utc( year < , month, day, hour, min, sec, usec > ) → time  
Time.utc( sec, min, hour, day, month, year, wday, yday, isdst, tz ) → time

---

Synonym for `Time.gm`.

```
Time.utc(2000,"jan",1,20,15,1) → Sat Jan 01 20:15:01 UTC 2000
```

## Instance methods

---

**+** *time + numeric* → *time*

Addition—Adds some number of seconds (possibly fractional) to *time* and returns that value as a new time.

```
t = Time.now → Thu Aug 26 22:38:02 CDT 2004
t + (60 * 60 * 24) → Fri Aug 27 22:38:02 CDT 2004
```

---

**-** *time - time* → *float*  
*time - numeric* → *time*

Difference—Returns a new time that represents the difference between two times, or subtracts the given number of seconds in *numeric* from *time*.

```
t = Time.now → Thu Aug 26 22:38:02 CDT 2004
t2 = t + 2592000 → Sat Sep 25 22:38:02 CDT 2004
t2 - t → 2592000.0
t2 - 2592000 → Thu Aug 26 22:38:02 CDT 2004
```

---

**<=>** *time <=> other\_time* → -1, 0, +1  
*time <=> numeric* → -1, 0, +1

Comparison—Compares *time* with *other\_time* or with *numeric*, which is the number of seconds (possibly fractional) since epoch.

```
t = Time.now → Thu Aug 26 22:38:02 CDT 2004
t2 = t + 2592000 → Sat Sep 25 22:38:02 CDT 2004
t <=> t2 → -1
t2 <=> t → 1
t <=> t → 0
```

---

**asctime** *time.asctime* → *string*

Returns a canonical string representation of *time*.

```
Time.now.asctime → "Thu Aug 26 22:38:02 2004"
```

---

**ctime** *time.ctime* → *string*

Synonym for `Time#asctime`.

---

**day** *time.day* → *int*

Returns the day of the month (1..n) for *time*.

```
t = Time.now → Thu Aug 26 22:38:02 CDT 2004
t.day → 26
```

---

**dst?** *time.dst?* → true or false

1.8

Synonym for `Time#isdst`.

```
Time.local(2000, 7, 1).dst? → true
Time.local(2000, 1, 1).dst? → false
```

---

**getgm** *time.getgm* → *time*

---

1.8 Returns a new Time object representing *time* in UTC.

```
t = Time.local(2000,1,1,20,15,1) → Sat Jan 01 20:15:01 CST 2000
t.gmt? → false
y = t.getgm → Sun Jan 02 02:15:01 UTC 2000
y.gmt? → true
t == y → true
```

---

**getlocal** *time.getlocal* → *time*

---

1.8 Returns a new Time object representing *time* in local time (using the local time zone in effect for this process).

```
t = Time.gm(2000,1,1,20,15,1) → Sat Jan 01 20:15:01 UTC 2000
t.gmt? → true
l = t.getlocal → Sat Jan 01 14:15:01 CST 2000
l.gmt? → false
t == l → true
```

---

**getutc** *time.getutc* → *time*

---

1.8 Synonym for Time#getgm.

---

**gmt?** *time.gmt?* → true or false

---

Returns true if *time* represents a time in UTC (GMT).

```
t = Time.now → Thu Aug 26 22:38:02 CDT 2004
t.gmt? → false
t = Time.gm(2000,1,1,20,15,1) → Sat Jan 01 20:15:01 UTC 2000
t.gmt? → true
```

---

**gmtime** *time.gmtime* → *time*

---

Converts *time* to UTC (GMT), modifying the receiver.

```
t = Time.now → Thu Aug 26 22:38:02 CDT 2004
t.gmt? → false
t.gmtime → Fri Aug 27 03:38:02 UTC 2004
t.gmt? → true
```

---

**gmt\_offset** *time.gmt\_offset* → int

---

1.8 Returns the offset in seconds between the timezone of *time* and UTC.

```
t = Time.gm(2000,1,1,20,15,1) → Sat Jan 01 20:15:01 UTC 2000
t.gmt_offset → 0
l = t.getlocal → Sat Jan 01 14:15:01 CST 2000
l.gmt_offset → -21600
```

---

**gmtoff** *time.gmtoff* → *int*

---

1.8    Synonym for `Time#gmt_offset`.

---

**hour** *time.hour* → *int*

---

Returns the hour of the day (0..23) for *time*.

```
t = Time.now → Thu Aug 26 22:38:02 CDT 2004
t.hour → 22
```

---

**isdst** *time.isdst* → true or false

---

Returns true if *time* occurs during Daylight Saving Time in its time zone.

```
Time.local(2000, 7, 1).isdst → true
Time.local(2000, 1, 1).isdst → false
```

---

**localtime** *time.localtime* → *time*

---

Converts *time* to local time (using the local time zone in effect for this process) modifying the receiver.

```
t = Time.gm(2000, "jan", 1, 20, 15, 1)
t.gmt? → true
t.localtime → Sat Jan 01 14:15:01 CST 2000
t.gmt? → false
```

---

**mday** *time.mday* → *int*

---

Synonym for `Time#day`.

---

**min** *time.min* → *int*

---

Returns the minute of the hour (0..59) for *time*.

```
t = Time.now → Thu Aug 26 22:38:03 CDT 2004
t.min → 38
```

---

**mon** *time.mon* → *int*

---

Returns the month of the year (1..12) for *time*.

```
t = Time.now → Thu Aug 26 22:38:03 CDT 2004
t.mon → 8
```

---

**month** *time.month* → *int*

---

Synonym for `Time#mon`.

---

**sec** *time.sec* → *int*

---

Returns the second of the minute  $(0..60)^4$  for *time*.

```
t = Time.now → Thu Aug 26 22:38:03 CDT 2004
t.sec → 3
```

---

**strftime** *time.strftime(format)* → *string*

---

Formats *time* according to the directives in the given format string. See Table 27.15 on the following page for the available values. Any text not listed as a directive will be passed through to the output string.

```
t = Time.now
t.strftime("Printed on %m/%d/%Y") → "Printed on 08/26/2004"
t.strftime("at %I:%M%p") → "at 10:38PM"
```

---

**to\_a** *time.to\_a* → *array*

---

Returns a ten-element *array* of values for *time*: [sec, min, hour, day, month, year, wday, yday, isdst, zone]. See the individual methods for an explanation of the valid ranges of each value. The ten elements can be passed directly to the methods `Time.utc` or `Time.local` to create a new `Time`.

```
now = Time.now → Thu Aug 26 22:38:03 CDT 2004
t = now.to_a → [3, 38, 22, 26, 8, 2004, 4, 239, true, "CDT"]
```

---

**to\_f** *time.to\_f* → *float*

---

Returns the value of *time* as a floating-point number of seconds since epoch.

```
t = Time.now
"%10.5f" % t.to_f → "1093577883.33171"
t.to_i → 1093577883
```

---

**to\_i** *time.to\_i* → *int*

---

Returns the value of *time* as an integer number of seconds since epoch.

```
t = Time.now
"%10.5f" % t.to_f → "1093577883.37052"
t.to_i → 1093577883
```

---

**to\_s** *time.to\_s* → *string*

---

Returns a string representing *time*. Equivalent to calling `Time#strftime` with a format string of `%a %b %d %H:%M:%S %Z %Y`.

```
Time.now.to_s → "Thu Aug 26 22:38:03 CDT 2004"
```

---

4. Yes, seconds really can range from zero to 60. This allows the system to inject leap seconds every now and then to correct for the fact that years are not really a convenient number of hours long.

Table 27.15. Time#strftime directives

Format	Meaning
%a	The abbreviated weekday name (“Sun”)
%A	The full weekday name (“Sunday”)
%b	The abbreviated month name (“Jan”)
%B	The full month name (“January”)
%c	The preferred local date and time representation
%d	Day of the month (01..31)
%H	Hour of the day, 24-hour clock (00..23)
%I	Hour of the day, 12-hour clock (01..12)
%j	Day of the year (001..366)
%m	Month of the year (01..12)
%M	Minute of the hour (00..59)
%p	Meridian indicator (“AM” or “PM”)
%S	Second of the minute (00..60)
%U	Week number of the current year, starting with the first Sunday as the first day of the first week (00..53)
%W	Week number of the current year, starting with the first Monday as the first day of the first week (00..53)
%w	Day of the week (Sunday is 0, 0..6)
%x	Preferred representation for the date alone, no time
%X	Preferred representation for the time alone, no date
%y	Year without a century (00..99)
%Y	Year with century
%Z	Time zone name
%%	Literal % character

---

**tv\_sec** *time.tv\_sec* → *int*

Synonym for Time#to\_i.

---

**tv\_usec** *time.tv\_usec* → *int*

Synonym for Time#usec.

---

**usec** *time.usec* → *int*

Returns just the number of microseconds for *time*.

```
t = Time.now → Thu Aug 26 22:38:03 CDT 2004
"%10.6f" % t.to_f → "1093577883.448204"
t.usec → 448204
```

**utc** *time.utc* → *time*

Synonym for `Time#gmtime`.

```
t = Time.now → Thu Aug 26 22:38:03 CDT 2004
t.utc? → false
t.utc → Fri Aug 27 03:38:03 UTC 2004
t.utc? → true
```

**utc?** *time.utc?* → true or false

Returns true if *time* represents a time in UTC (GMT).

```
t = Time.now → Thu Aug 26 22:38:03 CDT 2004
t.utc? → false
t = Time.gm(2000, "jan", 1, 20, 15, 1) → Sat Jan 01 20:15:01 UTC 2000
t.utc? → true
```

**utc\_offset** *time.utc\_offset* → *int*

1.8 Synonym for `Time#gmt_offset`.

**wday** *time.wday* → *int*

Returns an integer representing the day of the week, 0..6, with Sunday == 0.

```
t = Time.now → Thu Aug 26 22:38:03 CDT 2004
t.wday → 4
```

**yday** *time.yday* → *int*

Returns an integer representing the day of the year, 1..366.

```
t = Time.now → Thu Aug 26 22:38:03 CDT 2004
t.yday → 239
```

**year** *time.year* → *int*

Returns the year for *time* (including the century).

```
t = Time.now → Thu Aug 26 22:38:03 CDT 2004
t.year → 2004
```

**zone** *time.zone* → *string*

1.8 Returns the name of the time zone used for *time*. As of Ruby 1.8, returns “UTC” rather than “GMT” for UTC times.

```
t = Time.gm(2000, "jan", 1, 20, 15, 1)
t.zone → "UTC"
t = Time.local(2000, "jan", 1, 20, 15, 1)
t.zone → "CST"
```



## Class TrueClass < Object

The global value `true` is the only instance of class `TrueClass` and represents a logically true value in boolean expressions. The class provides operators allowing `true` to be used in logical expressions.

### Instance methods

---

**&** `true & obj → true or false`

---

And—Returns `false` if `obj` is `nil` or `false`, and returns `true` otherwise.

---

**^** `true ^ obj → true or false`

---

Exclusive Or—Returns `true` if `obj` is `nil` and returns `false` otherwise.

---

**|** `true | obj → true`

---

Or—Returns `true`. As `obj` is an argument to a method call, it is always evaluated; short-circuit evaluation is not performed in this case.

```

true | puts("or")
true || puts("logical or")

```

*produces:*

```

or

```

Class

**UnboundMethod** < Object1.8

Ruby supports two forms of objectified methods. Class Method is used to represent methods that are associated with a particular object: these method objects are bound to that object. Bound method objects for an object can be created using `Object#method`.

Ruby also supports unbound methods, which are methods objects that are not associated with a particular object. These can be created either by calling `unbind` on a bound method object or by calling `Module#instance_method`.

Unbound methods can be called only after they are bound to an object. That object must be a *kind\_of?* the method's original class.

```
class Square
 def area
 @side * @side
 end
 def initialize(side)
 @side = side
 end
end

area_unbound = Square.instance_method(:area)

s = Square.new(12)
area = area_unbound.bind(s)
area.call → 144
```

Unbound methods are a reference to the method at the time it was objectified: subsequent changes to the underlying class will not affect the unbound method.

```
class Test
 def test
 :original
 end
end
um = Test.instance_method(:test)
class Test
 def test
 :modified
 end
end
t = Test.new
t.test → :modified
um.bind(t).call → :original
```

## Instance methods

### arity

*umeth.arity* → *fixnum*

See `Method#arity` on page 522.

### bind

*umeth.bind(obj)* → *method*

1.8

Bind *umeth* to *obj*. If *Klass* was the class from which *umeth* was originally obtained, `obj.kind_of?(Klass)` must be true.

```
class A
 def test
 puts "In test, class = #{self.class}"
 end
end
class B < A
end
class C < B
end

um = B.instance_method(:test)
bm = um.bind(C.new)
bm.call
bm = um.bind(B.new)
bm.call
bm = um.bind(A.new)
bm.call
```

*produces:*

```
In test, class = C
In test, class = B
prog.rb:16:in `bind': bind argument must be an instance of B (TypeError)
from prog.rb:16
```

# Standard Library

---

The Ruby interpreter comes with a large number of classes, modules, and methods built in—they are available as part of the running program. When you need a facility that isn't part of the built-in repertoire, you'll often find it in a library that you can `require` into your program.

A large number of Ruby libraries are available on the Internet. Sites such as the Ruby Application Archive<sup>1</sup> and RubyForge<sup>2</sup> have great indices and a lot of code.

However, Ruby also ships as standard with a large number of libraries. Some of these are written in pure Ruby and will be available on all Ruby platforms. Others are Ruby extensions, and some of these will be present only if your system supports the resources that they need. All can be included into your Ruby program using `require`. And, unlike libraries you may find on the Internet, you can pretty much guarantee that all Ruby users will have these libraries already installed on their machines.

In this chapter, we present the standard libraries in a new *smorgasbord* format. Rather than go into depth on a few libraries, this chapter presents the entire contents of the standard library, one entry per page. For each library we give some introductory notes and typically give an example or two of use. You won't find detailed method descriptions here: for that consult the library's own documentation.

It's all very well suggesting that you “consult the library's own documentation,” but where can you find it? The answer is “it depends.” Some libraries have already been documented using RDoc (see Chapter 16). That means you can use the `ri` command to get their documentation. For example, from a command line, you may be able to see the following documentation on the `decode64` method in the Base64 standard library member.

- 
1. <http://raa.ruby-lang.org>
  2. <http://rubyforge.org>

```

% ri Base64.decode64
----- Base64#decode64
decode64(str)

Returns the Base64-decoded version of str.

require 'base64'
str = 'VGhpcyBpcyBsaW5lIG9uZQpUaGlzIG' +
 'lzIGxpbmUgdHdvClRoaxMgaXMgbGlu' +
 'ZSB0aHJlZQpBbmQgc28gb24uLi4K'
puts Base64.decode64(str)

Generates:

This is line one
This is line two
This is line three
And so on...

```

If there’s no RDoc documentation available, the next place to look is the library itself. If you have a source distribution of Ruby, these are in the `ext/` and `lib/` subdirectories. If instead you have a binary-only installation, you can still find the source of pure-Ruby library modules (normally in the `lib/ruby/1.8/` directory under your Ruby installation). Often, library source directories contain documentation that the author has not yet converted to RDoc format.

If you still can’t find documentation, turn to Google. Many of the Ruby standard libraries are also hosted as external projects. The authors develop them stand-alone and then periodically integrate the code into the standard Ruby distribution. For example, if you want detailed information on the API for the YAML library, Googling “yaml ruby” may lead you to <http://yaml4r.sourceforge.net>. After admiring *why the lucky stiff*’s artwork, a click will take you to his 40+ page reference manual.

The next port of call is the `ruby-talk` mailing list. Ask a (polite) question there, and chances are that you’ll get a knowledgeable respond within hours. See page 759 for pointers on how to subscribe.

And if you *still* can’t find documentation, you can always follow Obi Wan’s advice and do what we did when documenting Ruby—use the source. You’d be surprised at how easy it is to read the actual source of Ruby libraries and work out the details of usage.

Given a set of strings, calculate the set of unambiguous abbreviations for those strings, and return a hash where the keys are all the possible abbreviations and the values are the full strings. Thus, given input of “car” and “cone,” the keys pointing to “car” would be “ca” and “car,” and those pointing to “cone” would be “co,” “con,” and “cone.”

An optional pattern or a string may be specified—only those input strings matching the pattern, or beginning with the string, are considered for inclusion in the output hash.

Including the Abbrev library also adds an abbrev method to class Array.

- Show the abbreviation set of some words.

```
require 'abbrev'
```

```
Abbrev::abbrev(['ruby', 'rules']) → {"rules"=>"rules",
 "ruby"=>"ruby",
 "rul"=>"rules",
 "rub"=>"ruby",
 "rule"=>"rules"}
```

```
%w{ car cone }.abbrev → {"co"=>"cone",
 "con"=>"cone",
 "cone"=>"cone",
 "ca"=>"car", "car"=>"car"}
```

```
%w{ car cone }.abbrev("ca") → {"ca"=>"car",
 "car"=>"car"}
```

- A trivial command loop using abbreviations.

```
require 'abbrev'
COMMANDS = %w{ sample send start status stop }.abbrev
while line = gets
 line = line.chomp
 case COMMANDS[line]
 when "sample": # ...
 when "send": # ...
 # ...
 else
 STDERR.puts "Unknown command: #{line}"
 end
end
```

Perform encoding and decoding of binary data using a Base64 representation. This allows you to represent any binary data in purely printable characters. The encoding is specified in RFC 2045 (<http://www.faqs.org/rfcs/rfc2045.html>).

1.8

Prior to Ruby 1.8.2, these methods were added to the global namespace. This is now deprecated; the methods should instead be accessed as members of the Base64 module.

- Decode an encoded string.

```
require 'base64'
str = 'VGhpcyBpcyBsaW5lIG9uZQpUaGZlIG' +
 'lzIGxpbmUgdHdvClRoXMaXMaGlu' +
 'ZSB0aHJlZQpBbmQgc28gb24uLi4K'
puts Base64.decode64(str)
```

*produces:*

```
This is line one
This is line two
This is line three
And so on...
```

- Convert and return a string.

```
require 'base64'
puts Base64.encode64("Now is the time\nto learn Ruby")
```

*produces:*

```
Tm93IGlziHRoZSB0aW1lCnRvIGx1YXJuIFJlYnk=
```

- Convert a string into Base64 and print it to STDOUT.

```
require 'base64'
Base64.b64encode("Now is the time\nto learn Ruby")
```

*produces:*

```
Tm93IGlziHRoZSB0aW1lCnRvIGx1YXJuIFJlYnk=
```

Allows code execution to be timed and the results tabulated. The Benchmark module is easier to use if you include it in your top-level environment.

See also: Profile (page 696)

- Compare the costs of three kinds of method dispatch.

```
require 'benchmark'
include Benchmark
string = "Stormy Weather"
m = string.method(:length)
bm(6) do |x|
 x.report("call") { 10_000.times { m.call } }
 x.report("send") { 10_000.times { string.send(:length) } }
 x.report("eval") { 10_000.times { eval "string.length" } }
end
```

*produces:*

	user	system	total	real
call	0.020000	0.000000	0.020000 (	0.045998)
send	0.040000	0.000000	0.040000 (	0.051318)
eval	0.130000	0.000000	0.130000 (	0.177950)

- Which is better: reading all of a dictionary and splitting it, or splitting it line by line? Use `bmbm` to run a rehearsal before doing the timing.

```
require 'benchmark'
include Benchmark
bmbm(6) do |x|
 x.report("all") do
 str = File.read("/usr/share/dict/words")
 words = str.scan(/[-\w']+/)
 end
 x.report("lines") do
 words = []
 File.foreach("/usr/share/dict/words") do |line|
 words << line.chomp
 end
 end
end
```

*produces:*

	user	system	total	real
all	0.980000	0.070000	1.050000 (	1.256552)
lines	2.310000	0.120000	2.430000 (	2.720674)
			total:	3.480000sec

	user	system	total	real
all	0.870000	0.030000	0.900000 (	0.949623)
lines	1.720000	0.030000	1.750000 (	1.926910)



Ruby's standard Bignum class supports integers with large numbers of digits. The BigDecimal class supports decimal numbers with large numbers of decimal places. The standard library supports all the normal arithmetic operations. BigDecimal also comes with some extension libraries.

**bigdecimal/ludcmp**

Performs an LU decomposition of a matrix.

**bigdecimal/math**

Provides the transcendental functions *sqrt*, *sin*, *cos*, *atan*, *exp*, and *log*, along with functions for computing *PI* and *E*. All functions take an arbitrary precision argument.

**bigdecimal/jacobian**

Constructs the Jacobian (a matrix enumerating the partial derivatives) of a given function. Not dependent on BigDecimal.

**bigdecimal/newton**

Solves the roots of nonlinear function using Newton's method. Not dependent on BigDecimal.

**bigdecimal/nlsolve**

Wraps the bigdecimal/newton library for equations of BigDecimals.

You can find English-language documentation in the Ruby source distribution in the file `ext/bigdecimal/bigdecimal_en.html`.

```
require 'bigdecimal'
require 'bigdecimal/math'
include BigMath

pi = BigMath::PI(20) # 20 is the number of decimal digits

radius = BigDecimal("2.14156987652974674392")

area = pi * radius**2

area.to_s → "0.14408354044685604417672003380667956168
 8599846410445032583215824758780405545861
 780909930190528E2"

The same with regular floats

radius = 2.14156987652974674392

Math::PI * radius**2 → 14.4083540446856
```

The CGI class provides support for programs used as CGI (Common Gateway Interface) scripts in a Web server. CGI objects are initialized with data from the environment and from the HTTP request, and they provide convenient accessors to form data and cookies. They can also manage sessions using a variety of storage mechanisms. Class CGI also provides basic facilities for HTML generation and class methods to escape and unescape requests and HTML.

1.8

**Note:** The 1.8 implementation of CGI introduces a change in the way form data is accessed. See the `ri` documentation of `CGI#[]` and `CGI#params` for details.

See also: `CGI::Session` (page 640)

- Escape and unescape special characters in URLs and HTML. If the `$KCODE` variable is set to "u" (for UTF8), the library will convert from HTML's Unicode to internal UTF8.

```
require 'cgi'
CGI.escape('c:\My Files') → c%3A%5CMy+Files
CGI.unescape('c%3a%5cMy+Files') → c:\My Files
CGI::escapeHTML('"a"<b & c') → "a"<b & c

$KCODE = "u" # Use UTF8
CGI.unescapeHTML('"a"<=>b') → "a"<=>b
CGI.unescapeHTML('AA') → AA
CGI.unescapeHTML('πr²') → πr^2
```

- Access information from the incoming request.

```
require 'cgi'
c = CGI.new
c.auth_type → "basic"
c.user_agent → "Mozscape Explorari V5.6"
```

- Access form fields from an incoming request. Assume the following script is installed as `test.cgi` and the user linked to it using `http://mydomain.com/test.cgi?fred=10&barney=cat`.

```
require 'cgi'
c = CGI.new
c['fred'] → "10"
c.keys → ["barney", "fred"]
c.params → {"barney"=>["cat"], "fred"=>["10"]}
```

- If a form contains multiple fields with the same name, the corresponding values will be returned to the script as an array. The `[]` accessor returns just the first of these—index the result of the `params` method to get them all. In this example, assume the form has three fields called "name."

```
require 'cgi'
c = CGI.new
c['name'] → "fred"
c.params['name'] → ["fred", "wilma", "barney"]
c.keys → ["name"]
c.params → {"name"=>["fred", "wilma", "barney"]}
```

- Send a response to the browser. (Not many folks use this form of HTML generation. Consider one of the templating libraries—see page 226.)

```
require 'cgi'
cgi = CGI.new("html4Tr")
cgi.header("type" => "text/html", "expires" => Time.now + 30)
cgi.out do
 cgi.html do
 cgi.head{ cgi.title{"Hello World!"} } +
 cgi.body do
 cgi.pre do
 CGI::escapeHTML(
 "params: " + cgi.params.inspect + "\n" +
 "cookies: " + cgi.cookies.inspect + "\n")
 end
 end
 end
end
```

- Store a cookie in the client browser.

```
require 'cgi'
cgi = CGI.new("html4")
cookie = CGI::Cookie.new('name' => 'mycookie',
 'value' => 'chocolate chip',
 'expires' => Time.now + 3600)
cgi.out('cookie' => cookie) do
 cgi.head + cgi.body { "Cookie stored" }
end
```

- Retrieve a previously stored cookie.

```
require 'cgi'
cgi = CGI.new("html4")
cookie = cgi.cookies['mycookie']
cgi.out('cookie' => cookie) do
 cgi.head + cgi.body { "Flavor: " + cookie[0] }
end
```

A CGI::Session maintains a persistent state for Web users in a CGI environment. Sessions may be memory resident or may be stored on disk. See the discussion on page 233 for details.

See also: CGI (page 638)

```
require 'cgi'
require 'cgi/session'
cgi = CGI.new("html3")
sess = CGI::Session.new(cgi,
 "session_key" => "rubyweb",
 "prefix" => "web-session."
)

if sess['lastaccess']
 msg = "You were last here #{sess['lastaccess']}."
else
 msg = "Looks like you haven't been here for a while"
end

count = (sess["accesscount"] || 0).to_i
count += 1

msg << "<p>Number of visits: #{count}"

sess["accesscount"] = count
sess["lastaccess"] = Time.now.to_s
sess.close

cgi.out {
 cgi.html {
 cgi.body {
 msg
 }
 }
}
```

Class `Complex` represents complex numbers. As well as the methods here, including class `Complex` in your program alters class `Numeric` (and subclasses) in order to give the illusion that *all* numbers are complex (by giving them the methods `real`, `image`, `arg`, `polar`, `conjugate`, and `power!`).

```
require 'complex'
include Math

v1 = Complex(2,3) → Complex(2, 3)
v2 = 2.im → Complex(0, 2)
v1 + v2 → Complex(2, 5)
v1 * v2 → Complex(-6, 4)
v2**2 → Complex(-4, 0)
cos(v1) → Complex(-4.18962569096881, -9.10922789375534)
v1 < v2 → false
v2**2 == -4 → true

Euler's theorem
E**(PI*Complex::I) → Complex(-1.0, 1.22464679914735e-16)
```

Comma-separated data files are often used to transfer tabular information (and are a *lingua franca* for importing and exporting spreadsheet and database information).

Ruby's CSV library deals with arrays (corresponding to the rows in the CSV file) and strings (corresponding to the elements in a row). If an element in a row is missing, it will be represented as a `nil` in Ruby.

The files used in the following examples are:

**csvfile:**

```
12,eggs,2.89,
2,"shirt, blue",21.45,special
1,"""Hello Kitty"" bag",13.99
```

**csvfile\_hdr:**

```
Count, Description, Price
12,eggs,2.89,
2,"shirt, blue",21.45,special
1,"""Hello Kitty"" bag",13.99
```

- Read a file containing CSV data and process line-by-line.

```
require 'csv'
CSV.open("csvfile", "r") do |row|
 qty = row[0].to_i
 price = row[2].to_f
 printf "%20s: %5.2f %s\n", row[1], qty*price, row[3] || " ---"
end
```

*produces:*

```
 eggs: $34.68 ---
 shirt, blue: $42.90 special
"Hello Kitty" bag: $13.99 ---
```

- Some CSV files have a header line. Read it, and then process the rest of the file.

```
require 'csv'
reader = CSV.open("csvfile_hdr", "r")
header = reader.shift
reader.each {|row| process(header, row) }
```

- Write CSV data to an existing open stream (STDOUT in this case). Use `|` as the column separator.

```
require 'csv'
CSV::Writer.generate(STDOUT, '|') do |csv|
 csv << [1, "line 1", 27]
 csv << [2, nil, 123]
 csv << [3, "|bar|", 32.5]
end
```

*produces:*

```
1|line 1|27
2||123
3|"|bar|"|32.5
```

Library **Curses**

## CRT Screen Handling

Only if: curses or ncurses installed in target environment

The Curses library is a fairly thin wrapper around the C curses or ncurses libraries, allowing applications a device-independent way of drawing on consoles and other terminal-like devices. As a nod toward object-orientation, curses windows and mouse events are represented as Ruby objects. Otherwise, the standard curses calls and constants are simply defined in the Curses module.

```
Draw the paddle of a simple game of 'pong'. It moves
in response to the up and down keys
require 'curses'
include Curses

class Paddle
 HEIGHT = 4
 PADDLE = " \n" + "| \n"*HEIGHT + " "
 def initialize
 @top = (Curses::lines - HEIGHT)/2
 draw
 end
 def up
 @top -= 1 if @top > 1
 end
 def down
 @top += 1 if (@top + HEIGHT + 1) < lines
 end
 def draw
 setpos(@top-1, 0)
 addstr(PADDLE)
 refresh
 end
end

init_screen
begin
 crmode
 noecho
 stdscr.keypad(true)
 paddle = Paddle.new
 loop do
 case getch
 when ?Q, ?q : break
 when Key::UP : paddle.up
 when Key::DOWN : paddle.down
 else beep
 end
 paddle.draw
 end
end
ensure
 close_screen
end
```

The date library implements classes `Date` and `DateTime`, which provide a comprehensive set of facilities for storing, manipulating, and converting dates with or without time components. The classes can represent and manipulate civil, ordinal, commercial, Julian, and standard dates, starting January 1, 4713 BCE. The `DateTime` class extends `Date` with hours, minutes, seconds, and fractional seconds, and it provides some support for time zones. The classes also provide support for parsing and formatting date and datetime strings. The classes have a rich interface—consult the `ri` documentation for details. The introductory notes in the file `lib/date.rb` are also well worth reading.

See also: `ParseDate` (page 692)

- Experiment with various representations

```
require 'date'

d = Date.new(2000, 3, 31) → #<Date:
 4903269/2,0,2299161>
[d.year, d.yday, d.wday] → [2000, 91, 5]
[d.month, d.mday] → [3, 31]
[d.cyear, d.cweek, d.cwday] → [2000, 13, 5]
[d.jd, d.mjd] → [2451635, 51634]
d1 = Date.commercial(2000, 13, 7) → #<Date:
 4903273/2,0,2299161>
d1.to_s → "2000-04-02"
[d1.cwday, d1.wday] → [7, 0]
```

- Essential information about Christmas.

```
require 'date'
now = DateTime.now
year = now.year
year += 1 if now.month == 12 && now.day > 25
xmas = DateTime.new(year, 12, 25)
diff = xmas - now
puts "It's #{diff.to_i} days to Christmas"
h,m,s,frac = Date.day_fraction_to_time(diff)
s += frac.to_f
puts "That's #{h} hours, #{m} minutes, #{s} seconds"
puts "Christmas falls on a #{xmas.strftime('%A')}"
```

*produces:*

```
It's 119 days to Christmas
That's 2876 hours, 21 minutes, 28.0000094433912 seconds
Christmas falls on a Saturday
```



Library **DBM**

## Interface to DBM Databases

Only if: a DBM library is installed in target environment

DBM files implement simple, hashlike persistent stores. Many DBM implementations exist—the Ruby library can be configured to use one of the DBM libraries `db`, `dbm` (`ndbm`), `gdbm`, and `qdbm`. The interface to DBM files is similar to class `Hash`, except that DBM keys and values will be strings. This can cause confusion, as the conversion to a string is performed silently when the data is written. The DBM library is a wrapper around the lower-level access method. For true low-level access, see also the `GDBM` and `SDBM` libraries.

See also: `gdbm` (page 661), `sdbm` (page 709)

- Create a simple DBM file, then re-open it read-only and read some data. Note the conversion of a date object to its string form.

```
require 'dbm'
require 'date'

DBM.open("data.dbm") do |dbm|
 dbm['name'] = "Walter Wombat"
 dbm['dob'] = Date.new(1997, 12, 25)
end

DBM.open("data.dbm", nil, DBM::READER) do |dbm|
 p dbm.keys
 p dbm['dob']
 p dbm['dob'].class
end
```

*produces:*

```
["name", "dob"]
"1997-12-25"
String
```

- Read from the system's *aliases* file. Note the trailing null bytes on all strings.

```
require 'dbm'

DBM.open("/etc/aliases", nil) do |dbm|
 p dbm.keys
 p dbm["postfix\000"]
end
```

*produces:*

```
["postmaster\000", "daemon\000", "ftp-bugs\000",
 "operator\000", "abuse\000", "decode\000", "@\000",
 "mailer-daemon\000", "bin\000", "named\000", "nobody\
000", "uucp\000", "www\000", "postfix\000", "manager\
000", "dumper\000"]
"root\000"
```

Object delegation is a way of *composing* objects—extending an object with the capabilities of another—at runtime. The Ruby `Delegator` class implements a simple but powerful delegation scheme, where requests are automatically forwarded from a master class to delegates or their ancestors and where the delegate can be changed at runtime with a single method call.

See also: `Forwardable` (page 659)

- For simple cases where the class of the delegate is fixed, make the master class a subclass of `DelegateClass`, passing the name of the class to be delegated as a parameter. In the master class's `initialize` method, pass the object to be delegated to the superclass.

```
require 'delegate'

class Words < DelegateClass(Array)
 def initialize(list = "/usr/share/dict/words")
 words = File.read(list).split
 super(words)
 end
end

words = Words.new
words[9999] → "anticritique"
words.size → 234937
words.grep(/matz/) → ["matzo", "matzoon", "matzos", "matzoth"]
```

- Use `SimpleDelegator` to delegate to a particular object (which can be changed).

```
require 'delegate'

words = File.read("/usr/share/dict/words").split
names = File.read("/usr/share/dict/propernames").split

stats = SimpleDelegator.new(words)
stats.size → 234937
stats[226] → "abidingly"
stats.__setobj__(names)
stats.size → 1323
stats[226] → "Dave"
```

The Digest module is the home for a number of classes that implement secure digest algorithms: MD2, RIPEMD-160, SHA1, and SHA2 (256, 384, and 512 bit). The interface to all these classes is identical.

- You can create a binary or hex digest for a given string by calling the class method `digest` or `hexdigest`.
- You can also create an object (optionally passing in an initial string) and determine the object's hash by calling the `digest` or `hexdigest` instance methods. In this case you can then append to the string using the `update` method and then recover an updated hash value.
- Calculate some MD5 and SHA1 hashes.

```
require 'digest/md5'
require 'digest/sha1'
for hash_class in [Digest::MD5, Digest::SHA1]
 puts "Using #{hash_class.name}"
 # Calculate directly
 puts hash_class.hexdigest("hello world")
 # Or by accumulating
 digest = hash_class.new
 digest << "hello"
 digest << " "
 digest << "world"
 puts digest.hexdigest
 puts
end
```

*produces:*

```
Using Digest::MD5
5eb63bbbe01eeed093cb22bb8f5acdc3
5eb63bbbe01eeed093cb22bb8f5acdc3

Using Digest::SHA1
2aae6c35c94fcfb415dbe95f408b9ce91ee846ed
2aae6c35c94fcfb415dbe95f408b9ce91ee846ed
```

## Library DL Access Dynamically Loaded Libraries (.dll and .so)

Only if: Windows,  
or system supports  
dl library

The DL module interfaces to the underlying operating system's dynamic loading capabilities. On Windows boxes, it can be used to interface with functions in DLLs (replacing the Win32API class—see `dl/win32` for a compatible wrapper library). Under Unix it can load shared libraries. Because Ruby does not have typed method parameters or return values, you must define the types expected by the methods you call by specifying their signatures. This can be done using a C-like syntax (if you use the high-level methods in `dl/import`) or using explicit type specifiers in the lower-level DL module. Good documentation is provided in the source tree's `ext/dl/doc/` directory.

See also: `Win32API` (page 734)

- Here's a trivial C program that we'll build as a shared library.

```
#include <stdio.h>
int print_msg(text, number) {
 return printf("Text: %s (%d)\n", text, number);
}
```

- Generate a proxy to access the `print_msg` method in the shared library. The way this book is built, the shared library ends up in the subdirectory `code/dl`; this explains the name in the `dlopen` call.

```
require 'dl'
Message = DL.dlopen("code/dl/lib.so")
print_msg = Message["print_msg", "ISI"]
msg_size, args = print_msg.call("Answer", 42)
puts "Just wrote #{msg_size} bytes"
```

*produces:*

```
Text: Answer (42)
Just wrote 18 bytes
```

- We can also wrap the method in a module. Here we use an environment variable to set the path to the shared object. This is operating system specific.

```
ENV['DYLD_LIBRARY_PATH'] = ":code/dl" # Mac OS X
require 'dl/import'
module Message
 extend DL::Importable
 dload "lib.so"
 extern "int print_msg(char *, int)"
end
msg_size = Message.print_msg("Answer", 42)
puts "Just wrote #{msg_size} bytes"
```

*produces:*

```
Text: Answer (42)
Just wrote 18 bytes
```

dRuby allows Ruby objects to be distributed across a network connection. Although expressed in terms of clients and servers, once the initial connection is established, the protocol is effectively symmetrical: either side can invoke methods in objects on the other side. Normally, objects passed and returned by remote calls are passed by value; including the `DRbUndumped` module in an object forces it to be passed by reference (useful when implementing callbacks).

See also: Rinda (page 706), XMLRPC (page 736)

- This server program is *observable*—it notifies all registered listeners of changes to a count value.

```
require 'drb'
require 'drb/observer'
class Counter
 include DRb::DRbObservable
 def run
 5.times do |count|
 changed
 notify_observers(count)
 end
 end
end
counter = Counter.new
DRb.start_service('druby://localhost:9001', counter)
DRb.thread.join
```

- This client program interacts with the server, registering a listener object to receive callbacks before invoking the server's `run` method.

```
require 'drb'
class Listener
 include DRbUndumped
 def update(value)
 puts value
 end
end
DRb.start_service
counter = DRbObject.new(nil, "druby://localhost:9001")
listener = Listener.new
counter.add_observer(listener)
counter.run
```

Include the English library file in a Ruby script, and you can reference the global variables such as `$_` using less-cryptic names, listed in the following table.

---

<code>\$*</code>	<code>\$ARGV</code>	<code>\$\$</code>	<code>\$LOADED_FEATURES</code>
<code>\$?</code>	<code>\$CHILD_STATUS</code>	<code>\$&amp;</code>	<code>\$MATCH</code>
<code>\$&lt;</code>	<code>\$DEFAULT_INPUT</code>	<code>\$.</code>	<code>\$NR</code>
<code>\$&gt;</code>	<code>\$DEFAULT_OUTPUT</code>	<code>\$_</code>	<code>\$OFS</code>
<code>\$!</code>	<code>\$ERROR_INFO</code>	<code>\$\</code>	<code>\$ORS</code>
<code>\$@</code>	<code>\$ERROR_POSITION</code>	<code>\$_</code>	<code>\$OUTPUT_FIELD_SEPARATOR</code>
<code>\$;</code>	<code>\$FIELD_SEPARATOR</code>	<code>\$\</code>	<code>\$OUTPUT_RECORD_SEPARATOR</code>
<code>\$;</code>	<code>\$FS</code>	<code>\$\$</code>	<code>\$PID</code>
<code>\$=</code>	<code>\$IGNORECASE</code>	<code>\$'</code>	<code>\$POSTMATCH</code>
<code>\$.</code>	<code>\$INPUT_LINE_NUMBER</code>	<code>\$`</code>	<code>\$PREMATCH</code>
<code>\$/</code>	<code>\$INPUT_RECORD_SEPARATOR</code>	<code>\$\$</code>	<code>\$PROCESS_ID</code>
<code>\$~</code>	<code>\$LAST_MATCH_INFO</code>	<code>\$0</code>	<code>\$PROGRAM_NAME</code>
<code>\$+</code>	<code>\$LAST_PAREN_MATCH</code>	<code>\$/</code>	<code>\$RS</code>
<code>\$_</code>	<code>\$LAST_READ_LINE</code>		

---

```
require 'English'
$OUTPUT_FIELD_SEPARATOR = ' -- '
"waterbuffalo" =~ /buff/
print $LOADED_FEATURES, $POSTMATCH, $PID, "\n"
print $", $', $$, "\n"
```

*produces:*

```
English.rb -- alo -- 28035 --
English.rb -- alo -- 28035 --
```

The Ruby convention is that enumerable objects should define a method called `each` that returns the contents one item at a time. This `each` method is used as the basis of the `Enumerable` module, as well as the built-in `for` loop. Even if a class defines multiple enumeration methods, `Enumerable` can only use `each`.

The `Enumerator` module creates a new iterable object based on an existing object, mapping the `each` method in the new object to an arbitrary method in the original. This allows you to use standard Ruby enumeration techniques on arbitrary methods.

See also: `Enumerable` (page 433), `Generator` (page 662)

- Define an external iterator that returns all the keys in a hash.

```
require 'enumerator'
hash = { "cow" => "bovine", "cat" => "feline", "dog" => "canine" }
key_iter = Enumerable::Enumerator.new(hash, :each_key)
puts "Max key is #{key_iter.max}"
for key in key_iter
 puts "Key is #{key}"
end
```

*produces:*

```
Max key is dog
Key is cat
Key is cow
Key is dog
```

- Methods `to_enum` and `enum_for` also create `Enumerator` objects.

```
require 'enumerator'
hash = { "cow" => "bovine", "cat" => "feline", "dog" => "canine" }
key_iter = hash.enum_for(:each_key)
key_iter.min → "cat"
key_iter.max → "dog"
```

- Methods `each_slice` and `each_cons` return elements from an enumeration  $n$  elements at a time. `each_slice` returns disjoint sets, and `each_cons` returns a moving window over the collection.

```
require 'enumerator'
(1..7).each_slice(3) {|slice| print slice.inspect, " " }
puts
(1..7).each_cons(3) {|cons| print cons.inspect, " " }
```

*produces:*

```
[1, 2, 3] [4, 5, 6] [7]
[1, 2, 3] [2, 3, 4] [3, 4, 5] [4, 5, 6] [5, 6, 7]
```

ERB is a lightweight templating system, allowing you to intermix Ruby code and plain text. This is sometimes a convenient way to create HTML documents but also is usable in other plain-text situations. For other templating solutions, see [226](#).

ERB breaks its input text into checks of regular text and program fragments. It then builds a Ruby program that, when run, outputs the result text and executes the program fragments. Program fragments are enclosed between `<%` and `%>` markers. The exact interpretation of these fragments depends on the character following the opening `<%`, as shown in [Table 28.1](#) on the next page.

```
require 'erb'
input = %{\
<% high.downto(low) do |n| # set high, low externally %>
 <%= n %> green bottles, hanging on the wall
 <%= n %> green bottles, hanging on the wall
 And if one green bottle should accidentally fall
 There'd be <%= n-1 %> green bottles, hanging on the wall
<% end %>
}
high,low = 10, 8
erb = ERB.new(input)
erb.run
```

*produces:*

```
10 green bottles, hanging on the wall
10 green bottles, hanging on the wall
And if one green bottle should accidentally fall
There'd be 9 green bottles, hanging on the wall
. . .
```

An optional second parameter to `ERB.new` sets the safe level for evaluating expressions. If `nil`, expressions are evaluated in the current thread; otherwise a new thread is created, and its `SAFE` level is set to the parameter value.

The optional third parameter to `ERB.new` allows some control of the interpretation of the input and of the way whitespace is added to the output. If the third parameter is a string, and that string contains a percent sign, then ERB treats lines starting with a percent sign specially. Lines starting with a single percent sign are treated as if they were enclosed in `<%..%>`. Lines starting with a double percent sign are copied to the output with a single leading percent sign.

```
str = %{\
% 2.times do |i|
 This is line <%= i %>
%end
%% done}
ERB.new(str, 0, '%').run
```

*produces:*

```
⇒ This is line 0
 This is line 1
 % done
```



Table 28.1. Directives for ERB

Sequence	Action
<code>&lt;% ruby code %&gt;</code>	Insert the given Ruby code at this point in the generated program. If it outputs anything, include this output in the result.
<code>&lt;%= ruby expression %&gt;</code>	Evaluate expression and insert its value in the output of the generated program.
<code>&lt;## ... %&gt;</code>	Comment (ignored).
<code>&lt;% and %&gt;</code>	Replaced in the output by <code>&lt;% and%&gt;</code> respectively.

If the third parameter contains the string `<>` then a newline will not be written if an input line starts with an ERB directive and ends with `%>`. If the trim parameter contains `>`, then a newline will not be written if an input line ends `%>`.

```
str1 = %{\
* <%= "cat" %>
<%= "dog" %>
}
ERB.new(str1, 0, ">").run
ERB.new(str1, 0, "<>").run
```

*produces:*

```
* catdog* cat
dog
```

The `erb` library also defines the helper module `ERB::Util` that contains two methods: `html_escape` (aliased as `h`) and `url_encode` (aliased as `u`). These are equivalent to the CGI methods `escapeHTML` and `escape`, respectively (except `escape` encodes spaces as plus signs, and `url_encode` uses `%20`).

```
include ERB::Util
str1 = %{\
h(a) = <%= h(a) %>
u(a) = <%= u(a) %>
}
a = "< a & b >"
ERB.new(str1).run
```

*produces:*

```
h(a) = < a & b >
u(a) = %3C%20a%20%26%20b%20%3E
```

You may find the command-line utility `erb` is supplied with your Ruby distribution. This allows you to run `erb` substitutions on an input file; see `erb --help` for details.

Only if: Unix or  
Cygwin

The Etc module provides a number of methods for querying the passwd and group facilities on Unix systems.

- Find out information about the currently logged-in user.

```
require 'etc'

name = Etc.getlogin
info = Etc.getpwnam(name)
info.name → "dave"
info.uid → 502
info.dir → "/Users/dave"
info.shell → "/bin/bash"

group = Etc.getgrgid(info.gid)
group.name → "dave"
```

- Return the names of all users and groups on the system used to create this book.

```
require 'etc'

users = []
Etc.passwd {|passwd| users << passwd.name }
users.join(", ") → "nobody, root, daemon, unknown, smmsp, lp,
 postfix, www, eppc, mysql, sshd, qtss,
 cyrus, mailman, appserver, dave, testuser"

groups = []
Etc.group {|group| groups << group.name }
groups.join(", ") → "nobody, nogroup, wheel, daemon, kmem,
 sys, tty, operator, mail, bin, staff,
 smmsp, lp, postfix, postdrop, guest, utmp,
 uucp, dialer, network, www, mysql, sshd,
 qtss, mailman, appserverusr, admin,
 appserveradm, unknown, dave, testuser"
```

The `expect` library adds the method `expect` to all IO objects. This allows you to write code that waits for a particular string or pattern to be available from the I/O stream. The `expect` method is particularly useful with `pty` objects (see page 699) and with network connections to remote servers, where it can be used to coordinate the use of external interactive processes.

If the global variable `$expect_verbose` is true, the `expect` method writes all characters read from the I/O stream to `STDOUT`.

See also: `pty` (page 699)

- Connect to the local FTP server, log in, and print out the name of the user's directory. (Note that it would be a lot easier to do this using the `library`.)

```
This code might be specific to the particular
ftp daemon.
require 'expect'
require 'socket'
$expect_verbose = true
socket = TCPSocket.new('localhost', 'ftp')
socket.expect("ready")
socket.puts("user testuser")
socket.expect("Password required for testuser")
socket.puts("pass secret")
socket.expect("logged in.\r\n")
socket.puts("pwd")
puts(socket.gets)
socket.puts "quit"
```

*produces:*

```
220 localhost FTP server (lukemftpd 1.1) ready.
331 Password required for testuser.
230-
 Welcome to Darwin!
230 User testuser logged in.
257 "/Users/testuser" is the current directory.
```

Library **Fcntl**

## Symbolic Names for IO#fcntl Commands

The Fcntl module provides symbolic names for each of the host system's available fcntl constants (defined in fcntl.h). That is, if the host system has a constant named F\_GETLK defined in fcntl.h, then the Fcntl module will have a corresponding constant Fcntl::F\_GETLK with the same value as the header file's #define.

- Different operating system will have different Fcntl constants available. The value associated with a constant of a given name may also differ across platforms. Here are the values on my Mac OS X system.

```
require 'fcntl'
Fcntl.constants.sort.each do |name|
 printf "%10s: %04x\n", name, Fcntl.const_get(name)
end
```

*produces:*

```
FD_CLOEXEC: 0001
 F_DUPFD: 0000
 F_GETFD: 0001
 F_GETFL: 0003
 F_GETLK: 0007
 F_RDLCK: 0001
 F_SETFD: 0002
 F_SETFL: 0004
 F_SETLK: 0008
 F_SETLKW: 0009
 F_UNLCK: 0002
 F_WRLCK: 0003
O_ACCMODE: 0003
 O_APPEND: 0008
 O_CREAT: 0200
 O_EXCL: 0800
 O_NDELAY: 0004
 O_NOCTTY: 0000
O_NONBLOCK: 0004
 O_RDONLY: 0000
 O_RDWR: 0002
 O_TRUNC: 0400
 O_WRONLY: 0001
```

FileUtils is a collection of methods for manipulating files and directories. Although generally applicable, the model is particularly useful when writing installation scripts.

Many methods take a *src* and a *dest* parameter. If *dest* is a directory, then *src* may be a single filename or an array of filenames. For example, the following copies the files *a*, *b*, and *c* to */tmp*.

```
cp(%w{ a b c }, "/tmp")
```

Most functions take a set of options. These may be zero or more of

Option	Meaning
:verbose	Trace execution of each function (by default to STDERR, although this can be overridden by setting the class variable @fileutils_output).
:noop	Do not perform the action of the function (useful for testing scripts).
:force	Override some default conservative behavior of the method (for example overwriting an existing file).
:preserve	Attempt to preserve atime, mtime, and mode information from <i>src</i> in <i>dest</i> . (Setuid and setgid flags are always cleared.)

For maximum portability, use forward slashes to separate the directory components of filenames, even on Windows.

FileUtils contains three submodules which duplicate the top-level methods but with different default options: module FileUtils::Verbose sets the verbose option, module FileUtils::NoWrite sets noop, and FileUtils::DryRun sets verbose and noop.

## 1.8

See also: `un` (page 730)

```
require 'fileutils'
include FileUtils::Verbose
cd("/tmp") do
 cp("/etc/passwd", "tmp_passwd")
 chmod(0666, "tmp_passwd")
 cp_r("/usr/include/net/", "headers")
 rm("tmp_passwd") # Tidy up
 rm_rf("headers")
end
```

*produces:*

```
cd /tmp
cp /etc/passwd tmp_passwd
chmod 666 tmp_passwd
cp -r /usr/include/net/ headers
rm tmp_passwd
rm -rf headers
cd -
```

The Find module supports the top-down traversal of a set of file paths, given as arguments to the `find` method. If an argument is a file, its name is passed to the block. If it's a directory, then its name and the name of all its files and subdirectories will be passed in.

Within the block, the method `prune` may be called, which skips the current file or directory, restarting the loop with the next directory. If the current file is a directory, that directory will not be recursively entered.

```
require 'find'
Find.find("/etc/passwd", "code/cdjukebox") do |f|
 type = case
 when File.file?(f): "F"
 when File.directory?(f): "D"
 else "?"
 end
 puts "#{type}: #{f}"
 Find.prune if f =~ /CVS/
end
```

*produces:*

```
F: /etc/passwd
D: code/cdjukebox
F: code/cdjukebox/Makefile
F: code/cdjukebox/libcdjukebox.a
D: code/cdjukebox/CVS
F: code/cdjukebox/cdjukebox.o
F: code/cdjukebox/cdjukebox.h
F: code/cdjukebox/cdjukebox.c
```

Forwardable provides a mechanism to allow classes to delegate named method calls to other objects.

See also: Delegator (page 646)

- This simple symbol table uses a hash, exposing a subset of the hash's methods.

```
require 'forwardable'

class SymbolTable
 extend Forwardable
 def_delegator(:@hash, :[], :lookup)
 def_delegator(:@hash, :[]=, :add)
 def_delegators(:@hash, :size, :has_key?)
 def initialize
 @hash = Hash.new
 end
end

st = SymbolTable.new
st.add('cat', 'feline animal') → "feline animal"
st.add('dog', 'canine animal') → "canine animal"
st.add('cow', 'bovine animal') → "bovine animal"

st.has_key?('cow') → true
st.lookup('dog') → "canine animal"
```

- Forwards can also be defined for individual objects by extending them with the SingleForwardable module. It's hard to think of a good reason to use this feature, so here's a silly one....

```
require 'forwardable'
TRICKS = ["roll over", "play dead"]
dog = "rover"
dog.extend SingleForwardable
dog.def_delegator(:TRICKS, :each, :can)
dog.can do |trick|
 puts trick
end

produces:
roll over
play dead
```

Library **ftools**

## Extra Tools for Class File

The `ftools` library adds methods to class `File`, primarily aimed at programs that move and copy files, such as installers. The `FileUtils` library is now recommended over `ftools`.

See also: `fileutils` (page 657)

- Install the file `testfile` into the `/tmp` directory. Don't bother copying the file if the target already exists and is the same as the original.

```
require 'ftools'
def install_if_different(source, dest)
 if File.exist?(dest) && File.compare(source, dest)
 puts "#{dest} is up to date"
 else
 File.copy(source, dest)
 puts "#{source} copied to #{dest}"
 end
end
install_if_different('testfile', '/tmp/testfile')
puts "Second time..."
install_if_different('testfile', '/tmp/testfile')
puts "Done"
```

*produces:*

```
testfile copied to /tmp/testfile
Second time...
/tmp/testfile is up to date
Done
```

- Do the same (with slightly different logging) using `FTool`'s `install` method.

```
require 'ftools'
File.install('testfile', '/tmp', 0644, true)
puts "Second time..."
File.install('testfile', '/tmp', 0644, true)
puts "Done"
```

*produces:*

```
testfile -> /tmp/testfile
chmod 0644 /tmp/testfile
Second time...
Done
```



Only if: gdbm  
library available

Interfaces to the gdbm database library.<sup>3</sup> Although the DBM library provides generic access to gdbm databases, it doesn't expose some features of the full gdbm interface. The GDBM library gives you access to underlying gdbm features such as the cache size, synchronization mode, reorganization, and locking. Only one process may have a GDBM database open for writing (unless locking is disabled).

See also: DBM (page 645), SDBM (page 709)

- Store some values into a database, and then read them back. The second parameter to the open method specifies the file mode, and the next parameter uses two flags which (1) create the database if it doesn't exist, and (2) force all writes to be synced to disk. Create on open is the default Ruby gdbm behavior.

```
require 'gdbm'
GDBM.open("data.dbm", 0644, GDBM::WRCREAT | GDBM::SYNC) do |dbm|
 dbm['name'] = "Walter Wombat"
 dbm['dob'] = "1969-12-25"
 dbm['uses'] = "Ruby"
end
GDBM.open("data.dbm") do |dbm|
 p dbm.keys
 p dbm['dob']
 dbm.delete('dob')
 p dbm.keys
end
```

*produces:*

```
["uses", "dob", "name"]
"1969-12-25"
["uses", "name"]
```

- Open a database read-only. Note that the attempt to delete a key fails.

```
require 'gdbm'
GDBM.open("data.dbm", 0, GDBM::READER) do |dbm|
 p dbm.keys
 dbm.delete('name')
end
produces:
["uses", "name"]
prog.rb:4:in `delete': Reader can't delete (GDBMError)
from prog.rb:4
from prog.rb:2:in `open'
```

---

3. <http://www.gnu.org/software/gdbm/gdbm.html>

The generator library implements external iterators (as in Java and C++) based either on Enumerable objects or on a block that yields values. The Generator class is a simple iterator. The library also include SyncEnumerator, which creates an Enumerable object that iterates over several collections at once.

See also: Enumerable (page 433), Enumerator (page 651)

- Iterate over an Enumerable object.

```
require 'generator'
gen = Generator.new(1..4)
while gen.next?
 print gen.next, "--"
end
```

*produces:*

```
1--2--3--4--
```

- Iterate over a block.

```
require 'generator'
gen = Generator.new do |result|
 result.yield "Start"
 3.times {|i| result.yield i}
 result.yield "done"
end
while gen.next?
 print gen.next, "--"
end
```

*produces:*

```
Start--0--1--2--done--
```

- Iterate over two collections at once.

```
require 'generator'
gen = SyncEnumerator.new(1..3, "a".."c")
gen.each {|num, char| print num, "(", char, ") " }
```

*produces:*

```
1(a) 2(b) 3(c)
```

Class `GetoptLong` supports GNU-style command-line option parsing. Options may be a minus sign (`-`) followed by a single character, or two minus signs (`--`) followed by a name (a long option). Long options may be abbreviated to their shortest unambiguous lengths.

A single internal option may have multiple external representations. For example, the option to control verbose output could be any of `-v`, `--verbose`, or `--details`. Some options may also take an associated value.

Each internal option is passed to `GetoptLong` as an array, containing strings representing the option's external forms and a flag. The flag specifies how `GetoptLong` is to associate an argument with the option (`NO_ARGUMENT`, `REQUIRED_ARGUMENT`, or `OPTIONAL_ARGUMENT`).

If the environment variable `POSIXLY_CORRECT` is set, all options must precede non-options on the command line. Otherwise, the default behavior of `GetoptLong` is to reorganize the command line to put the options at the front. This behavior may be changed by setting `GetoptLong#ordering=` to one of the constants `PERMUTE`, `REQUIRE_ORDER`, or `RETURN_IN_ORDER`. `POSIXLY_CORRECT` may not be overridden.

See also: `OptionParser` (page 690)

```
Call using "ruby example.rb --size 10k -v -q a.txt b.doc"
require 'getoptlong'
specify the options we accept and initialize
the option parser
opts = GetoptLong.new(
 ["--size", "-s", GetoptLong::REQUIRED_ARGUMENT],
 ["--verbose", "-v", GetoptLong::NO_ARGUMENT],
 ["--query", "-q", GetoptLong::NO_ARGUMENT],
 ["--check", "--valid", "-c", GetoptLong::NO_ARGUMENT]
)
process the parsed options
opts.each do |opt, arg|
 puts "Option: #{opt}, arg #{arg.inspect}"
end
puts "Remaining args: #{ARGV.join(', ')}"
```

*produces:*

```
Option: --size, arg "10k"
Option: --verbose, arg ""
Option: --query, arg ""
Remaining args: a.txt, b.doc
```

Library **GServer**

## Generic TCP Server

Simple framework for writing TCP servers. Subclass the GServer class, set the port (and potentially other parameters) in the constructor, and then implement a serve method to handle incoming requests.

GServer manages a thread pool for incoming connections, so your serve method may be running in multiple threads in parallel.

You can run multiple GServer copies on different ports in the same application.

- When a connection is made on port 2000, respond with the current time as a string. Terminate after handling three requests.

```
require 'gserver'
class TimeServer < GServer
 def initialize
 super(2000)
 @count = 3
 end
 def serve(client)
 client.puts Time.now.to_s
 @count -= 1
 stop if @count.zero?
 end
end
server = TimeServer.new
server.audit = true # enable logging
server.start
server.join
```

- You can test this server by telnetting into *localhost* on port 2000.

```
% telnet localhost 2000
produces:
Trying 127.0.0.1...
Connected to localhost.
Escape character is '^]'.
Thu Aug 26 22:38:41 CDT 2004
Connection closed by foreign host.
```

Only if: libiconv  
installed

The Iconv class is an interface to the Open Group's iconv library, which supports the translation of strings between character encodings. For a list of the supported encodings on your platform, see the `iconv_open` man pages for your system.

An Iconv object encapsulates a conversion descriptor, which contains the information needed to convert from one encoding to another. The converter can be used multiple times, until closed.

The conversion method `iconv` can be called multiple times to convert input strings. At the end, it should be called with a `nil` argument to flush out any remaining output.

- Convert from ISO-8859-1 to UTF-16.

```
require 'iconv'

conv = Iconv.new("UTF-16", "ISO-8859-1")
result = conv.iconv("hello")
result << conv.iconv(nil)
result → "\376\377\000h\000e\000l\000l\000o"
```

- Do the same conversion using a class method. Not we use `Iconv.conv`, which returns a single string, as opposed to `Iconv.iconv`, which returns an array of strings.

```
require 'iconv'
result = Iconv.conv("UTF-16", "ISO-8859-1", "hello")
result → "\376\377\000h\000e\000l\000l\000o"
```

- Convert *olé* from UTF-8 to ISO-8859-1.

```
require 'iconv'
result = Iconv.conv("ISO-8859-1", "UTF-8", "o1\303\251")
result → "o1\351"
```

- Convert *olé* from UTF-8 to ASCII. This throws an exception, as ASCII doesn't have an *é* character.

```
require 'iconv'
result = Iconv.conv("ASCII", "UTF-8", "o1\303\251")
```

*produces:*

```
prog.rb:2:in `conv': "\303\251" (Iconv::IllegalSequence)
from prog.rb:2
```

- This time, convert to ASCII with transliteration, which shows approximations of missing characters.

```
require 'iconv'
result = Iconv.iconv("ASCII//TRANSLIT", "UTF-8", "o1\303\251")
result → ["o1'e"]
```

## Library

**IO/Wait**

## Check for Pending Data to Be Read

Only if:  
FIONREAD feature  
in ioctl(2)

Including the library `io/wait` adds the methods `IO#ready?` and `IO#wait` to the standard `IO` class. These allow an `IO` object opened on a stream (not a file) to be queried to see if data is available to be read without reading it and to wait for a given number of bytes to become available.

- Set up a pipe between two processes, and write ten bytes at a time into it. Periodically see how much data is available.

```
require 'io/wait'
reader, writer = IO.pipe
if (pid = fork)
 writer.close
 8.times do
 sleep 0.03
 len = reader.ready?
 puts "Ready? = #{len.inspect}"
 puts(reader.sysread(len)) if len
 end
 Process.waitpid(pid)
else
 reader.close
 5.times do |n|
 sleep 0.04
 writer.write n.to_s * 10
 end
 writer.close
end
```

*produces:*

```
Ready? = 10
0000000000
Ready? = nil
Ready? = 10
1111111111
Ready? = 10
2222222222
Ready? = 10
3333333333
Ready? = nil
Ready? = 10
4444444444
Ready? = nil
```

Class `IPAddr` holds and manipulates Internet Protocol (IP) addresses. Each address contains three parts: an address, a mask, and an address family. The family will typically be `AF_INET` for IPv4 and IPv6 addresses. The class contains methods for extracting parts of an address, checking for IPv4 compatible addresses (and IPv4 mapped IPv6 addresses), testing whether an address falls within a subnet and many other functions. It is also interesting in that it contains as data its own unit tests.

```
require 'ipaddr'

v4 = IPAddr.new('192.168.23.0/24')
v4 → #<IPAddr: IPv4:192.168.23.0/ 255.255.255.0>
v4.mask(16) → #<IPAddr: IPv4:192.168.0.0/ 255.255.0.0>
v4.reverse → "0.23.168.192.in-addr.arpa"
v6 = IPAddr.new('3ffe:505:2::1')
v6 → #<IPAddr:
 IPv6:3ffe:0505:0002:0000:0000:0000:0000:0001/
 ffff:ffff:ffff:ffff:ffff:ffff:ffff:ffff>
v6.mask(48) → #<IPAddr:
 IPv6:3ffe:0505:0002:0000:0000:0000:0000:0000/
 ffff:ffff:ffff:0000:0000:0000:0000:0000>

the value for 'family' is OS dependent. This
value is for OS X
v6.family → 30

other = IPAddr.new("192.168.23.56")
v4.include?(other) → true
```

Requiring the jcode library augments the built-in `String` class with additional support for EUC and SJIS Japanese encodings and UTF8. This is effective only if `$KCODE` is one of EUC, SJIS, or UTF8. The following methods are updated: `chop!`, `chop`, `delete!`, `delete`, `squeeze!`, `squeeze`, `succ!`, `succ`, `tr!`, `tr`, `tr_s!`, and `tr_s`.

For example, the string `"\342\210\202x/\342\210\202y"` contains nine 8-bit characters. However, the sequence `\343\210\202` could also be interpreted as a single UTF-8 character (a math delta symbol, making the string  $\delta x/\delta y$ ). If we don't tell Ruby about the encoding, it treats each byte in the string as a separate character:

- Without encoding support, the string contains bytes.

```
$KCODE = "NONE"
require 'jcode'

str = "\342\210\202x/\342\210\202y"
str.length → 9
str.jlength → 9
str.jcount("\210") → 2
str.chop! → "\342\210\202x/\342\210\202"
str.chop! → "\342\210\202x/\342\210"

str.each_char {|ch| print ch.inspect, " "}
```

*produces:*

```
"\342" "\210" "\202" "x" "/" "\342" "\210" "\202" "y"
```

- However, tell Ruby that it is dealing with UTF8 strings and the result changes.

```
$KCODE = 'UTF8'
require 'jcode'

str = "\342\210\202x/\342\210\202y"
str.length → 9
str.jlength → 5
str.jcount("\210") → 0
str.chop! → "\delta/\delta"
str.chop! → "\delta/"

str = "\342\210\202x/\342\210\202y"
str.each_char {|ch| print ch.inspect, " "}
```

*produces:*

```
"\delta" "x" "/" "\delta" "y"
```



Writes log messages to a file or stream. Supports automatic time- or size-based rolling of log files. Messages can be assigned severities, and only those messages at or above the logger's current reporting level will be logged.

- During development, you may want to see all messages.

```
require 'logger'
log = Logger.new(STDOUT)
log.level = Logger::DEBUG
log.datetime_format = "%H:%H:%S"
log.info("Application starting")
3.times do |i|
 log.debug("Executing loop, i = #{i}")
 temperature = some_calculation(i) # defined externally
 if temperature > 50
 log.warn("Possible overheat. i = #{i}")
 end
end
log.info("Application terminating")
```

*produces:*

```
I, [22:22:42#28184] INFO -- : Application starting
D, [22:22:42#28184] DEBUG -- : Executing loop, i = 0
D, [22:22:42#28184] DEBUG -- : Executing loop, i = 1
D, [22:22:42#28184] DEBUG -- : Executing loop, i = 2
W, [22:22:42#28184] WARN -- : Possible overheat. i = 2
I, [22:22:42#28184] INFO -- : Application terminating
```

- In deployment, you can turn off anything below INFO.

```
require 'logger'
log = Logger.new(STDOUT)
log.level = Logger::INFO
log.datetime_format = "%H:%H:%S"
as above...
```

*produces:*

```
I, [22:22:42#28186] INFO -- : Application starting
W, [22:22:42#28186] WARN -- : Possible overheat. i = 2
I, [22:22:42#28186] INFO -- : Application terminating
```

- Log to a file, which is rotated when it gets to about 10k bytes. Keep up to five old files.

```
require 'logger'
log = Logger.new("application.log", 5, 10*1024)
log.info("Application starting")
...
```

Class `Mail` provides basic parsing for e-mail messages. It can read an individual message from a named file, or it can be called repeatedly to read messages from a stream on an opened mbox format file. Each `Mail` object represents a single e-mail message, which is split into a header and a body. The body is an array of lines, and the header is a hash indexed by the header name. `Mail` correctly joins multiline headers.

- Read a single e-mail from a file.

```
require 'mailread'

MAILBOX = "/Users/dave/Library/Mail/Mailboxes/Ruby/Talk.mbox/mbox"
msg = Mail.new(MAILBOX)
msg.header.keys → ["Status", "List-software", "Message-id",
 "Subject", "Received",
 "X-spambayes-classification",
 "List-unsubscribe", "Posted",
 "X-spam-level", "Content-type", "From",
 "X-virus-scanned", "List-post",
 "X-spam-status",
 "Content-transfer-encoding", "X-mlserver",
 "To", "In-reply-to", "X-ml-info",
 "X-mail-count", "Date", "List-owner",
 "X-ml-name", "References", "Reply-to",
 "Delivered-to", "List-help", "Lines",
 "Mime-version", "X-spam-checker-version",
 "List-id", "Precedence"]
msg.body[0] → "On Sat, 14 Aug 2004 03:02:42 +0900, Curt
 Hibbs <curt@hibbs.com> wrote:\n"
msg.body[1] → "> We've change the name of the project from
 \"Ruby Installer for Windows\" to\n"
msg.body[2] → "> the \"One-Click Ruby Installer\" because
 we are branching out more platforms\n"
```

- Read successive messages from an mbox format file.

```
require 'mailread'

MAILBOX = "/Users/dave/Library/Mail/Mailboxes/Ruby/Talk.mbox/mbox"
mbox = File.open(MAILBOX)
count = 0
lines = 0
while !mbox.eof?
 msg = Mail.new(mbox)
 count += 1
 lines += msg.header['Lines'].to_i
end

count → 180
lines → 5927
```

The `mathn` library attempts to bring some unity to numbers under Ruby, making classes `Bignum`, `Complex`, `Fixnum`, `Integer`, and `Rational` work and play better together.

- Types will tend to convert between themselves in a more natural way (so, for example, `Complex::I` squared will evaluate to `-1`, rather than `Complex[-1, 0]`).
- Division will tend to produce more accurate results. The conventional division operator (`/`) is redefined to use `quo`, which doesn't round (`quo` is documented on page 545).
- Related to the previous point, rational numbers will be used in preference to floats when possible. Dividing one by two results in the rational number  $\frac{1}{2}$ , rather than `0.5` (or `0`, the result of normal integer division).

See also: `Matrix` (page 673), `Rational` (page 700), `Complex` (page 641)

- Without `mathn`

```
require 'matrix'
require 'complex'
```

```
36/16 → 2
Math.sqrt(36/16) → 1.4142135623731
```

```
Complex::I * Complex::I → Complex(-1, 0)
```

```
m = Matrix[[1,2],[3,4]]
i = m.inv
```

```
i*m → $\begin{pmatrix} 1 & 0 \\ -2 & -2 \end{pmatrix}$
```

```
(36/16)**-2 → 0.25
(36.0/16.0)**-2 → 0.197530864197531
(-36/16)**-2 → 0.11111111111111111
```

```
(36/16)**(1/2) → 1
(-36/16)**(1/2) → 1
```

```
(36/16)**(-1/2) → 0.5
(-36/16)**(-1/2) → -0.3333333333333333
```

```
Matrix.diagonal(6,7,8)/3 → $\begin{pmatrix} 2 & 0 & 0 \\ 0 & 2 & 0 \\ 0 & 0 & 2 \end{pmatrix}$
```

- With mathn:

```
require 'mathn'
require 'matrix'
require 'complex'
```

```
36/16 → 9/4
Math.sqrt(36/16) → 3/2
```

```
Complex::I * Complex::I → -1
```

```
m = Matrix[[1,2],[3,4]]
i = m.inv
```

```
i*m → $\begin{pmatrix} 1 & 0 \\ 0 & 1 \end{pmatrix}$
```

```
(36/16)**-2 → 16/81
(36.0/16.0)**-2 → 0.197530864197531
(-36/16)**-2 → 16/81
```

```
(36/16)**(1/2) → 3/2
(-36/16)**(1/2) → Complex(9.18485099360515e-17, 1.5)
```

```
(36/16)**(-1/2) → 2/3
(-36/16)**(-1/2) → Complex(4.08215599715784e-17,
-0.666666666666667)
```

```
Matrix.diagonal(6,7,8)/3 → $\begin{pmatrix} 2 & 0 & 0 \\ 0 & 7/3 & 0 \\ 0 & 0 & 8/3 \end{pmatrix}$
```

- The mathn library also extends the number classes to include new functionality and adds a new class Prime.

```
require 'mathn'
primes = Prime.new
3.times { puts primes.succ }
primes.each { |p| puts p; break if p > 20 }
```

*produces:*

```
2
3
5
7
11
13
17
19
23
```

The `matrix` library defines classes `Matrix` and `Vector`, representing rectangular matrices and vectors. As well as the normal arithmetic operations, they provide methods for matrix-specific functions (such as `rank`, `inverse`, and `determinant`) and a number of constructor methods (for creating special-case matrices—zero, identity, diagonal, singular, and vector).

Because by default integer arithmetic truncates, the determinant of integer matrices may be incorrectly calculated unless you also require the `mathn` library.

See also: `mathn` (page 671), `Rational` (page 700)

```
require 'matrix'
require 'mathn'
```

```
m1 = Matrix[[2, 1], [-1, 1]] → $\begin{pmatrix} 2 & 1 \\ -1 & 1 \end{pmatrix}$

m1[0,1] → 1

m1.inv → $\begin{pmatrix} 1/3 & -1/3 \\ 1/3 & 2/3 \end{pmatrix}$

m1 * m1.inv → $\begin{pmatrix} 1 & 0 \\ 0 & 1 \end{pmatrix}$

m1.determinant → 3

m1.singular? → false

m2 = Matrix[[1,2,3], [4,5,6], [7,8,9]] → $\begin{pmatrix} 1 & 2 & 3 \\ 4 & 5 & 6 \\ 7 & 8 & 9 \end{pmatrix}$

m2.minor(1, 2, 1, 2) → $\begin{pmatrix} 5 & 6 \\ 8 & 9 \end{pmatrix}$

m2.rank → 2

v1 = Vector[3, 4] → Vector[3, 4]

v1.covector → (3 4)

m1 * v1 → Vector[10, 1]
```

Monitors are a form of mutual-exclusion mechanism first proposed back in 1974. They allow separate threads to define shared resources which will be accessed exclusively, and they provide a mechanism for a thread to wait for resources to become available in a controlled way.

The `monitor` library actually defines three separate ways of using monitors: as a parent class, as a mixin, and as an extension to a particular object. Examples of all three (and other code showing monitors in action) starts on page 134. In this section we document the module form of `Monitor`. The class form is effectively identical. In both the class form and when including `MonitorMixin` in an existing class it is essential to invoke `super` in the class's `initialize` method.

See also: `Mutex` (page 675), `Sync` (page 717), `Thread` (page 612)

```
require 'monitor'
require 'mathn'
numbers = []
numbers.extend(MonitorMixin)
number_added = numbers.new_cond

Reporter thread
Thread.new do
 loop do
 numbers.synchronize do
 number_added.wait_while { numbers.empty? }
 puts numbers.shift
 end
 end
end

Prime number generator thread
generator = Thread.new do
 p = Prime.new
 5.times do
 numbers.synchronize do
 numbers << p.succ
 number_added.signal
 end
 end
end
generator.join

produces:
2
3
5
7
11
```

The `Mutex` class allows threads to gain exclusive access to some shared resource. That is, only one thread may hold the lock at any given time. Other threads may choose to wait for the lock to become available or may choose to get an immediate error indicating that the lock is not available. The library also implements condition variables, allowing a thread to give up control while holding a mutex and regain the lock when the resource becomes available, and queues, allowing threads to pass messages safely. We describe threading in Chapter 11 on page 127, and discuss *monitors*, an alternative synchronization mechanism, starting on page 134.

See also: `Monitor` (page 674), `Sync` (page 717), `Queue` (page 722), `Thread` (page 612)

```
require 'thread'
class Resource
 attr_reader :left, :times_had_to_wait
 def initialize(count)
 @left = count
 @times_had_to_wait = 0
 @mutex = Mutex.new
 @empty = ConditionVariable.new
 end
 def use
 @mutex.synchronize do
 while @left <= 0
 @times_had_to_wait += 1
 @empty.wait(@mutex)
 end
 @left -= 1
 end
 end
 def release
 @mutex.synchronize do
 @left += 1
 @empty.signal if @left == 1
 end
 end
end

def do_something_with(resource)
 resource.use
 sleep 0.001 # to simulate doing something that takes time
 resource.release
end

resource = Resource.new(2)
user1 = Thread.new { 100.times { do_something_with(resource) } }
user2 = Thread.new { 100.times { do_something_with(resource) } }
user3 = Thread.new { 100.times { do_something_with(resource) } }
user1.join; user2.join; user3.join

resource.times_had_to_wait → 152
```

`mutex_m` is a variant of class `Mutex` (contained in the `thread` library documented on the preceding page) that allows mutex facilities to be mixed into any object.

The `Mutex_m` module defines methods that correspond to those in `Mutex` but with the prefix `mu_` (so that `lock` is defined as `mu_lock` and so on). It then aliases these to the original `Mutex` names.

See also: `Mutex` (page 675), `Sync` (page 717), `Thread` (page 612)

```
require 'mutex_m'

class Counter
 include Mutex_m
 attr_reader :count
 def initialize
 @count = 0
 super
 end
 def tick
 lock
 @count += 1
 unlock
 end
end

c = Counter.new

t1 = Thread.new { 10000.times { c.tick } }
t2 = Thread.new { 10000.times { c.tick } }

t1.join
t2.join

c.count → 20000
```



The `net/ftp` library implements a File Transfer Protocol (FTP) client. As well as data transfer commands (`getbinaryfile`, `gettextfile`, `list`, `putbinaryfile`, and `puttextfile`), the library supports the full complement of server commands (`acct`, `chdir`, `delete`, `mdtm`, `mkdir`, `nlst`, `rename`, `rmdir`, `pwd`, `size`, `status`, and `system`). Anonymous and password-authenticated sessions are supported. Connections may be active or passive.

See also: `open-uri` (page [686](#))

```
require 'net/ftp'
ftp = Net::FTP.new('ftp.netlab.co.jp')
ftp.login
ftp.chdir('pub/lang/ruby/contrib')
files = ftp.list('n*')
ftp.getbinaryfile('nif.rb-0.91.gz', 'nif.gz', 1024)
ftp.close
```

The `net/http` library provides a simple client to fetch headers and Web page contents using the HTTP protocol.

The interface to the `get`, `post`, and `head` methods has changed between Ruby 1.6 and 1.8. Now, a single response object is returned, with the content of the response accessible through the response's `body` method. In addition, these methods no longer raise exceptions on recoverable errors.

See also: [OpenSSL](#) (page 688), [open-uri](#) (page 686), [URI](#) (page 731)

- Open a connection and fetch a page, displaying the response code and message, header information, and some of the body.

```
require 'net/http'
Net::HTTP.start('www.pragmaticprogrammer.com') do |http|
 response = http.get('/index.html')
 puts "Code = #{response.code}"
 puts "Message = #{response.message}"
 response.each {|key, val| printf "%-14s = %-40.40s\n", key, val }
 p response.body[400, 55]
end
```

*produces:*

```
Code = 200
Message = OK
last-modified = Fri, 27 Aug 2004 02:25:48 GMT
content-type = text/html
etag = "b00d226-35b4-412e9bac"
date = Fri, 27 Aug 2004 03:38:47 GMT
server = Rapidsite/Apa/1.3.31 (Unix) FrontPage/5.
content-length = 13748
accept-ranges = bytes
"-selling book 'The Pragmatic Programmer' and The\n "
```

- Fetch a single page, displaying the response code and message, header information, and some of the body.

```
require 'net/http'
response = Net::HTTP.get_response('www.pragmaticprogrammer.com',
 '/index.html')

puts "Code = #{response.code}"
puts "Message = #{response.message}"
response.each {|key, val| printf "%-14s = %-40.40s\n", key, val }
p response.body[400, 55]
```

*produces:*

```
Code = 200
Message = OK
last-modified = Fri, 27 Aug 2004 02:25:48 GMT
```

```

content-type = text/html
etag = "b00d226-35b4-412e9bac"
date = Fri, 27 Aug 2004 03:38:49 GMT
server = Rapidsite/Apa/1.3.31 (Unix) FrontPage/5.
content-length = 13748
accept-ranges = bytes
"-selling book 'The Pragmatic Programmer' and The\n "

```

- Follow redirections (the `open-uri` library does this automatically). This code comes from the RDoc documentation.

```

require 'net/http'
require 'uri'
def fetch(uri_str, limit=10)
 fail 'http redirect too deep' if limit.zero?
 puts "Trying: #{uri_str}"
 response = Net::HTTP.get_response(URI.parse(uri_str))
 case response
 when Net::HTTPSuccess
 response
 when Net::HTTPRedirection
 fetch(response['location'], limit-1)
 else
 response.error!
 end
end
response = fetch('http://www.ruby-lang.org/')
p response.body[500, 55]

```

*produces:*

```

Trying: http://www.ruby-lang.org
Trying: http://www.ruby-lang.org/en/
"rg">\n\t<link rel="start" title="Top" href="."/>\n\t<meta h

```

- Search Dave's blog by posting form data and reading back the response.

```

require 'net/http'
Net::HTTP.start('pragprog.com') do |query|
 response = query.post("/pragdave", "terms=jolt&handler=searching")
 response.body.scan(%r{(.*?)}m) do
 |title|
 puts title
 end
 end
end

```

*produces:*

```

We're Jolt Finalists!
We Got a Jolt Award!

```

The Internet Mail Access Protocol (IMAP) is used to allow mail clients to access mail servers. It supports plain text login and the IMAP login and CRAM-MD5 authentication mechanisms. Once connected, the library supports threading, so multiple interactions with the server may take place at the same time.

The examples that follow are taken with minor modifications from the RDoc documentation in the library source file.

See also: `Net::POP` (page 681)

- List senders and subjects of messages to “dave” in the INBOX.

```
require 'net/imap'
imap = Net::IMAP.new('my.mailserver.com')
imap.authenticate('LOGIN', 'dave', 'secret')
imap.examine('INBOX')
puts "Message count: #{ imap.responses["EXISTS"]}"
imap.search(["TO", "dave"]).each do |message_id|
 envelope = imap.fetch(message_id, "ENVELOPE")[0].attr["ENVELOPE"]
 puts "#{envelope.from[0].name}: \t#{envelope.subject}"
end
```

- Move all messages with a date in April 2003 from the folder Mail/sent-mail to Mail/sent-apr03.

```
require 'net/imap'
imap = Net::IMAP.new('my.mailserver.com')
imap.authenticate('LOGIN', 'dave', 'secret')
imap.select('Mail/sent-mail')
if not imap.list('Mail/', 'sent-apr03')
 imap.create('Mail/sent-apr03')
end
imap.search(["BEFORE", "01-May-2003",
 "SINCE", "1-Apr-2003"]).each do |message_id|
 imap.copy(message_id, "Mail/sent-apr03")
 imap.store(message_id, "+FLAGS", [:Deleted])
end
imap.expunge
```

The `net/pop` library provides a simple client to fetch and delete mail on a Post Office Protocol (POP) server.

The class `Net::POP3` is used to access a POP server, returning a list of `Net::POPMail` objects, one per message stored on the server. These `POPMail` objects are then used to fetch and/or delete individual messages.

The library also provides class `APOP`, an alternative to the `POP3` class that performs authentication.

```
require 'net/pop'
pop = Net::POP3.new('server.ruby-stuff.com')
pop.start('joe', 'secret') do |server|
 msg = server.mails[0]
 # Print the 'From:' header line
 from = msg.header.split("\r\n").grep(/^From: /)[0]
 puts from
 puts
 puts "Full message:"
 text = msg.pop
 puts text
end
```

*produces:*

From: dave@facet.ruby-stuff.com (Dave Thomas)

Full message:

Return-Path: <dave@facet.ruby-stuff.com>

Received: from facet.ruby-stuff.com (facet.ruby-stuff.com [10.96.0.122])  
by pragprog.com (8.11.6/8.11.6) with ESMTP id i2PJMw701809  
for <joe@carat.ruby-stuff.com>; Thu, 25 Mar 2004 13:22:32 -0600

Received: by facet.ruby-stuff.com (Postfix, from userid 502)  
id 4AF228B1BD; Thu, 25 Mar 2004 13:22:36 -0600 (CST)

To: joe@carat.ruby-stuff.com

Subject: Try out the new features!

Message-Id: <20040325192236.4AF228B1BD@facet.ruby-stuff.com>

Date: Thu, 25 Mar 2004 13:22:36 -0600 (CST)

From: dave@facet.ruby-stuff.com (Dave Thomas)

Status: R0

Ruby 1.8 has a boatload of new features, both in the core language and in the supplied libraries.

Try it out!

The `net/smtp` library provides a simple client to send electronic mail using the Simple Mail Transfer Protocol (SMTP). It does not assist in the creation of the message payload—it simply delivers messages once an RFC822 message has been constructed.

- Send an e-mail from a string.

```
require 'net/smtp'
msg = "Subject: Test\n\nNow is the time\n"
Net::SMTP.start('pragprog.com') do |smtp|
 smtp.send_message(msg, 'dave@pragprog.com', ['dave'])
end
```

- Send an e-mail using an SMTP object and an adapter.

```
require 'net/smtp'
Net::SMTP.start('pragprog.com', 25, "pragprog.com") do |smtp|
 smtp.open_message_stream('dave@pragprog.com', # from
 ['dave'] # to
) do |stream|
 stream.puts "Subject: Test1"
 stream.puts
 stream.puts "And so is this"
 end
end
```

- Send an e-mail to a server requiring CRAM-MD5 authentication.

```
require 'net/smtp'
msg = "Subject: Test\n\nNow is the time\n"
Net::SMTP.start('pragprog.com', 25, 'pragprog.com',
 'user', 'password', :cram_md5) do |smtp|
 smtp.send_message(msg, 'dave@pragprog.com', ['dave'])
end
```

The `net/telnet` library provides a complete implementation of a telnet client and includes features that make it a convenient mechanism for interacting with nontelnet services.

Class `Net::Telnet` delegates to class `Socket`. As a result, the methods of `Socket` and its parent, class `IO`, are available through `Net::Telnet` objects.

- Connect to a localhost, run the `date` command, and disconnect.

```
require 'net/telnet'
tn = Net::Telnet.new({})
tn.login "guest", "secret"
tn.cmd "date" → "date\nThu Aug 26 22:38:56 CDT 2004\n% "
tn.close → nil
```

- The methods `new`, `cmd`, `login`, and `waitfor` take an optional block. If present, the block is passed output from the server as it is received by the routine. This can be used to provide realtime output, rather than waiting (for example) for a login to complete before displaying the server's response.

```
require 'net/telnet'
tn = Net::Telnet.new({}) {|str| print str }
tn.login("guest", "secret") {|str| print str }
tn.cmd("date") {|str| print str }
tn.close
```

*produces:*

```
Connected to localhost.
Darwin/BSD (wireless_2.local.thomases.com) (ttypl)
login: guest
Password:Last login: Thu Aug 26 22:38:56 from localhost
Welcome to Darwin!
% date
Thu Aug 26 22:38:57 CDT 2004
%
```

- Get the time from an NTP server.

```
require 'net/telnet'
tn = Net::Telnet.new('Host' => 'time.nonexistent.org',
 'Port' => 'time',
 'Timeout' => 60,
 'Telnetmode' => false)
atomic_time = tn.recv(4).unpack('N')[0]
puts "Atomic time: " + Time.at(atomic_time - 2208988800).to_s
puts "Local time: " + Time.now.to_s
```

*produces:*

```
Atomic time: Thu Aug 26 22:38:56 CDT 2004
Local time: Thu Aug 26 22:38:59 CDT 2004
```

The NKF module is a wrapper around Itaru Ichikawa's Network Kanji Filter (NKF) library (version 1.7). It provides functions to guess at the encoding of JIS, EUC, and SJIS streams, and to convert from one encoding to another.

- Unlike the interpreter, which uses strings to represent the encodings, NKF uses integer constants.

```
require 'nkf'
NKF::AUTO → 0
NKF::JIS → 1
NKF::EUC → 2
NKF::SJIS → 3
```

- Guess at the encoding of a string. (Thanks to Nobu Nakada for the examples on this page.)

```
require 'nkf'

NKF.guess("Yukihiro Matsumoto") → 0
NKF.guess("\eBDbHf-Rm\e(B") → 1
NKF.guess("\244\336\244\304\244\342\244\310\244\346\244\255\244\322\244\355") → 2
NKF.guess("\202\334\202\302\202\340\202\306\202\344\202\253\202\320\202\353") → 3
```

- The `NKF.nkf` method takes two parameters. The first is a set of options, passed on the the NKF library. The second is the string to translate. The following examples assume that your console is set up to accomodate Japanese characters. The text at the end of the three ruby commands is Yukihiro Matsumoto.

```
$ ruby -e 'p *ARGV' まつもと ゆきひろ
"\244\336\244\304\244\342\244\310\244\346\244\255\244\322\244\355"
$ ruby -rnkf -e 'p NKF.nkf(*ARGV)' - -Es まつもと ゆきひろ
"\202\334\202\302\202\340\202\306\202\344\202\253\202\320\202\353"
$ ruby -rnkf -e 'p NKF.nkf(*ARGV)' - -Ej まつもと ゆきひろ
"\eBDbHf-Rm\e(B"
```



Library **Observable**

## The Observer Pattern

The Observer pattern, also known as Publish/Subscribe, provides a simple mechanism for one object (the source) to inform a set of interested third-party objects when its state changes (see *Design Patterns* [GHJV95]). In the Ruby implementation, the notifying class mixes in the module `Observable`, which provides the methods for managing the associated observer objects. The observers must implement the `update` method to receive notifications.

```
require 'observer'

class CheckWaterTemperature # Periodically check the water
 include Observable
 def run
 last_temp = nil
 loop do
 temp = Temperature.fetch # external class...
 puts "Current temperature: #{temp}"
 if temp != last_temp
 changed # notify observers
 notify_observers(Time.now, temp)
 last_temp = temp
 end
 end
 end
end

class Warner
 def initialize(&limit)
 @limit = limit
 end
 def update(time, temp) # callback for observer
 if @limit.call(temp)
 puts "--- #{time.to_s}: Temperature outside range: #{temp}"
 end
 end
end

checker = CheckWaterTemperature.new
checker.add_observer(Warner.new {|t| t < 80})
checker.add_observer(Warner.new {|t| t > 120})
checker.run
```

*produces:*

```
Current temperature: 83
Current temperature: 75
--- Thu Aug 26 22:38:59 CDT 2004: Temperature outside range: 75
Current temperature: 90
Current temperature: 134
--- Thu Aug 26 22:38:59 CDT 2004: Temperature outside range: 134
Current temperature: 134
Current temperature: 112
Current temperature: 79
--- Thu Aug 26 22:38:59 CDT 2004: Temperature outside range: 79
```

The `open-uri` library extends `Kernel#open`, allowing it to accept URIs for FTP and HTTP as well as local filenames. Once opened, these resources can be treated as if they were local files, accessed using conventional IO methods. The URI passed to `open` is either a string containing an HTTP or FTP URL, or a URI object (described on page 731). When opening an HTTP resource, the method automatically handles redirection and proxies. When using an FTP resource, the method logs in as an anonymous user.

The IO object returned by `open` in these cases is extended to support methods that return meta-information from the request: `content_type`, `charset`, `content_encoding`, `last_modified`, `status`, `base_uri`, `meta`.

See also: [URI \(page 731\)](#)

```
require 'open-uri'
require 'pp'

open('http://localhost/index.html') do |f|
 puts "URI: #{f.base_uri}"
 puts "Content-type: #{f.content_type}, charset: #{f.charset}"
 puts "Encoding: #{f.content_encoding}"
 puts "Last modified: #{f.last_modified}"
 puts "Status: #{f.status.inspect}"
 pp f.meta
 puts "----"
 3.times {|i| puts "#{i}: #{f.gets}" }
end
```

*produces:*

```
URI: http://localhost/index.html
Content-type: text/html, charset: iso-8859-1
Encoding:
Last modified: Wed Jul 18 23:44:21 UTC 2001
Status: ["200", "OK"]
{"vary"=>"negotiate,accept-language,accept-charset",
 "last-modified"=>"Wed, 18 Jul 2001 23:44:21 GMT",
 "content-location"=>"index.html.en",
 "date"=>"Fri, 27 Aug 2004 03:38:59 GMT",
 "etag"=>"\"6657-5b0-3b561f55;411edab5\"",
 "content-type"=>"text/html",
 "content-language"=>"en",
 "server"=>"Apache/1.3.29 (Darwin)",
 "content-length"=>"1456",
 "tcn"=>"choice",
 "accept-ranges"=>"bytes"}

0: <!DOCTYPE html PUBLIC "-//W3C//DTD XHTML 1.0 Transitional//EN"
1: "http://www.w3.org/TR/xhtml1/DTD/xhtml1-transitional.dtd">
2: <html xmlns="http://www.w3.org/1999/xhtml">
```

Runs a command in a subprocess. Data written to *stdin* can be read by the subprocess, and data written to standard output and standard error in the subprocess will be available on the *stdout* and *stderr* streams. The subprocess is actually run as a grandchild, and as a result `Process#waitall` cannot be used to wait for its termination (hence the sleep in the following example).

```
require 'open3'
Open3.popen3('bc') do | stdin, stdout, stderr |
 Thread.new { loop { puts "Err stream: #{stderr.gets}" } }
 Thread.new { loop { puts "Output stream: #{stdout.gets}" } }
 stdin.puts "3 * 4"
 stdin.puts "1 / 0"
 stdin.puts "2 ^ 5"
 sleep 0.1
end
```

*produces:*

```
Output stream: 12
Err stream: Runtime error (func=(main), adr=3): Divide by zero
Output stream: 32
Err stream:
```

Library **OpenSSL**

## SSL Library

Only if: OpenSSL  
library available

The Ruby OpenSSL extension wraps the freely available OpenSSL library. It provides Secure Sockets Layer and Transport Layer Security (SSL and TLS) protocols, allowing for secure communications over networks. The library provides functions for certificate creation and management, message signing, and encryption/decryption. It also provides wrappers to simplify access to https servers, along with secure FTP. The interface to the library is large (roughly 330 methods), but the average Ruby user will probably only use a small subset of the library's capabilities.

See also: `Net::FTP` (page 677), `Net::HTTP` (page 678), `Socket` (page 714)

- Access a secure Web site using HTTPS. Note that SSL is used to tunnel to the site, but the requested page also requires standard HTTP basic authorization.

```
require 'net/https'
USER = "xxx"
PW = "yyy"
site = Net::HTTP.new("www.securestuff.com", 443)
site.use_ssl = true
response = site.get2("/cgi-bin/cokerecipe.cgi",
 'Authorization' => 'Basic ' +
 ["#{USER}:#{PW}"].pack('m').strip)
```

- Create a socket that uses SSL. This isn't a good example of accessing a Web site. However, it illustrates how a socket can be encrypted.

```
require 'socket'
require 'openssl'
socket = TCPSocket.new("www.secure-stuff.com", 443)
ssl_context = OpenSSL::SSL::SSLContext.new()
unless ssl_context.verify_mode
 warn "warning: peer certificate won't be verified this session."
 ssl_context.verify_mode = OpenSSL::SSL::VERIFY_NONE
end
sslsocket = OpenSSL::SSL::SSLSocket.new(socket, ssl_context)
sslsocket.sync_close = true
sslsocket.connect
sslsocket.puts("GET /secret-info.shtml")
while line = sslsocket.gets
 p line
end
```

**Library** **OpenStruct**

## Open (dynamic) Structure

An open structure is an object whose attributes are created dynamically when first assigned. In other words, if *obj* is an instance of an `OpenStruct`, then the statement `obj.abc=1` will create the attribute *abc* in *obj*, and then assign the value 1 to it.

```
require 'ostruct'
```

```
os = OpenStruct.new("f1" => "one", :f2 => "two")
os.f3 = "cat"
os.f4 = 99
os.f1 → "one"
os.f2 → "two"
os.f3 → "cat"
os.f4 → 99
```

OptionParser is a flexible and extensible way to parse command-line arguments. It has a particularly rich abstraction of the concept of an option.

- An option can have multiple short names (options preceded by a single hyphen) and multiple long names (options preceded by two hyphens). Thus, an option that displays help may be available as `-h`, `-?`, `--help`, and `--about`. Users may abbreviate long option names to the shortest nonambiguous prefix.
- An option may be specified as having no argument, an optional argument, or a required argument. Arguments can be validated against patterns or lists of valid values.
- Arguments may be returned as objects of any type (not just strings). The argument type system is extensible (we add Date handling in the example).
- Arguments can have one or more lines of descriptive text, used when generating usage information.

Options are specified using the `on` and `def` methods. These methods take a variable number of arguments that cumulatively build a definition of each option. The arguments accepted by these methods are listed in Table 28.2 on the following page.

See also: `GetoptLong` (page 663)

```
require 'optparse'
require 'date'

Add Dates as a new option type
OptionParser.accept(Date, /(\d+)-(\d+)-(\d+)/) do |d, mon, day, year|
 Date.new(year.to_i, mon.to_i, day.to_i)
end

opts = OptionParser.new
opts.on("-x") {|val| puts "-x seen" }
opts.on("-s", "--size VAL", Integer) {|val| puts "-s #{val}" }
opts.on("-a", "--at DATE", Date) {|val| puts "-a #{val}" }
my_argv = ["--size", "1234", "-x", "-a", "12-25-2003", "fred", "wilma"]
rest = opts.parse(*my_argv)
puts "Remainder = #{rest.join(', ')}"
puts opts.to_s
```

*produces:*

```
-s 1234
-x seen
-a 2003-12-25
Remainder = fred, wilma
Usage: myprog [options]
 -x
 -s, --size VAL
 -a, --at DATE
```

Table 28.2. Option definition arguments

<b>"-x" "-xARG" "-x=ARG" "-x[OPT]" "-x[=OPT]" "-x PLACE"</b>
Option has short name x. First form has no argument, next two have mandatory argument, next two have optional argument, last specifies argument follows option. The short names may also be specified as a range (such as "-[a-c]").
<b>"--switch" "--switch=ARG" "--switch=[OPT]" "--switch PLACE"</b>
Option has long name switch. First form has no argument, next has a mandatory argument, the next has an optional argument, and the last specifies the argument follows the switch.
<b>"--no-switch"</b>
Defines a option whose default value is false.
<b>"=ARG" "= [OPT]"</b>
Argument for this option is mandatory or optional. For example, the following code says there's an option known by the aliases -x, -y, and -z that takes a mandatory argument, shown in the usage as N. <code>opt.on("-x", "-y", "-z", "=N")</code>
<b>"description"</b>
Any string that doesn't start - or = is used as a description for this option in the summary. Multiple descriptions may be given; they'll be shown on additional lines.
<b>/pattern/</b>
Any argument must match the given pattern.
<b>array</b>
Argument must be one of the values from array.
<b>proc or method</b>
Argument type conversion is performed by the given proc or method (rather than using the block associated with the on or def method call).
<b>ClassName</b>
Argument must match that defined for ClassName, which may be predefined or added using <code>OptionParser.accept</code> . Built-in argument classes are
<b>Object:</b> Any string. No conversion. This is the default.
<b>String:</b> Any nonempty string. No conversion.
<b>Integer:</b> Ruby/C-like integer with optional sign (Oddd is octal, 0bddd binary, 0xddd hexadecimal). Converts to Integer.
<b>Float:</b> Float number format. Converts to Float.
<b>Numeric:</b> Generic numeric format. Converts to Integer for integers, Float for floats.
<b>Array:</b> Argument must be of list of strings separated by a comma.
<b>OptionParser::DecimalInteger:</b> Decimal integer. Converted to Integer.
<b>OptionParser::OctalInteger:</b> Ruby/C-like octal/hexadecimal/binary integer.
<b>OptionParser::DecimalNumeric:</b> Decimal integer/float number. Integers converted to Integer, floats to Float.
<b>TrueClass, FalseClass:</b> Boolean switch.

**Library** **ParseDate** Parse a Date String

The ParseDate module defines a single method, ParseDate.parsedate, which converts a date and/or time string into an array of Fixnum values representing the date and/or time's constituents (year, month, day, hour, minute, second, time zone, and weekday). nil is returned for fields that cannot be parsed from the string. If the result contains a year that is less than 100 and the *guess* parameter is true, parsedate will return a year value equal to *year* plus 2000 if *year* is less than 69, and will return *year* plus 1900 otherwise.

See also: Date (page 644)

string	guess	ParseDate::parsedate(string, guess)							
		yy	mm	dd	hh	min	sec	zone	wd
1999-09-05 23:55:21+0900	F	1999	9	5	23	55	21	+0900	-
1983-12-25	F	1983	12	25	-	-	-	-	-
1965-11-10 T13:45	F	1965	11	10	13	45	-	-	-
10/9/75 1:30pm	F	75	10	9	13	30	-	-	-
10/9/75 1:30pm	T	1975	10	9	13	30	-	-	-
Wed Feb 2 17:15:49 CST 2000	F	2000	2	2	17	15	49	CST	3
Tue, 02-Mar-99 11:20:32 GMT	F	99	3	2	11	20	32	GMT	2
Tue, 02-Mar-99 11:20:32 GMT	T	1999	3	2	11	20	32	GMT	2
12-January-1990, 04:00 WET	F	1990	1	12	4	0	-	WET	-
4/3/99	F	99	4	3	-	-	-	-	-
4/3/99	T	1999	4	3	-	-	-	-	-
10th February, 1976	F	1976	2	10	-	-	-	-	-
March 1st, 84	T	1984	3	1	-	-	-	-	-
Friday	F	-	-	-	-	-	-	-	5



A Pathname represents the absolute or relative name of a file. It has two distinct uses. First, it allows manipulation of the parts of a file path (extracting components, building new paths, and so on). Second (and somewhat confusingly), it acts as a façade for some methods in classes Dir, File, and module FileTest, forwarding on calls for the file named by the Pathname object.

See also: File (page 444)

- Path name manipulation:

```
require 'pathname'

p1 = Pathname.new("/usr/bin") → #<Pathname:/usr/bin>
p2 = Pathname.new("ruby") → #<Pathname:ruby>
p3 = p1 + p2 → #<Pathname:/usr/bin/ruby>
p4 = p2 + p1 → #<Pathname:/usr/bin>
p3.parent → #<Pathname:/usr/bin>
p3.parent.parent → #<Pathname:/usr>
p1.absolute? → true
p2.absolute? → false
p3.split → [#<Pathname:/usr/bin>,
 #<Pathname:ruby>]

p5 = Pathname.new("testdir") → #<Pathname:testdir>

p5.realpath → #<Pathname:/Users/dave/Work/rubybook/testdir>
p5.children → [#<Pathname:testdir/config.h>,
 #<Pathname:testdir/main.rb>]
```

- Pathname as proxy for file and directory status requests.

```
require 'pathname'

p1 = Pathname.new("/usr/bin/ruby")
p1.file? → true
p1.directory? → false
p1.executable? → true
p1.size → 1913444

p2 = Pathname.new("testfile") → #<Pathname:testfile>

p2.read → "This is line one\nThis is
 line two\nThis is line
 three\nAnd so on...\n"

p2.readlines → ["This is line one\n", "This
 is line two\n", "This is line
 three\n", "And so on...\n"]
```

PP uses the `PrettyPrint` library to format the results of inspecting Ruby objects. As well as the methods in the class, it defines a global function, `pp`, which works like the existing `p` method but which formats its output.

PP has a default layout for all Ruby objects. However, you can override the way it handles a class by defining the method `pretty_print`, which takes a PP object as a parameter. It should use that PP object's methods `text`, `breakable`, `nest`, `group`, and `pp` to format its output (see `PrettyPrint` for details).

See also: `PrettyPrint` (page 695), `YAML` (page 737)

- Compare “p” and “pp.”

```
require 'pp'
Customer = Struct.new(:name, :sex, :dob, :country)
cust = Customer.new("Walter Wall", "Male", "12/25/1960", "Niue")
puts "Regular print"
p cust
puts "\nPretty print"
pp cust

produces:

Regular print
#<struct Customer name="Walter Wall", sex="Male", dob="12/25/1960",
 country="Niue">

Pretty print
#<struct Customer
 name="Walter Wall",
 sex="Male",
 dob="12/25/1960",
 country="Niue">
```

- You can tell PP not to display an object if it has already displayed it.

```
require 'pp'
a = "string"
b = [a]
c = [b, b]
PP.sharing_detection = false
pp c
PP.sharing_detection = true
pp c

produces:

[["string"], ["string"]]
[["string"], [...]]
```

**Library** **PrettyPrint**

## General Pretty Printer

PrettyPrint implements a pretty printer for structured text. It handles details of wrapping, grouping, and indentation. The PP library uses PrettyPrint to generate more legible dumps of Ruby objects.

See also: PP (page 694)

- The following program prints a chart of Ruby's classes, showing subclasses as a bracketed list following the parent. To save some space, we show just the classes in the Numeric branch of the tree.

```
require 'prettyprint'
require 'complex'
require 'rational'
@children = Hash.new { |h,k| h[k] = Array.new }
ObjectSpace.each_object(Class) do |cls|
 @children[cls.superclass] << cls if cls <= Numeric
end
def print_children_of(printer, cls)
 printer.text(cls.name)
 kids = @children[cls].sort_by {|k| k.name}
 unless kids.empty?
 printer.group(0, " [", "]") do
 printer.nest(3) do
 printer.breakable
 kids.each_with_index do |k, i|
 printer.breakable unless i.zero?
 print_children_of(printer, k)
 end
 end
 printer.breakable
 end
 end
end
printer = PrettyPrint.new($stdout, 30)
print_children_of(printer, Object)
printer.flush

produces:
Object [
 Numeric [
 Complex
 Float
 Integer [
 Bignum
 Fixnum
]
 Rational
]
]
```

The profile library is a trivial wrapper around the Profiler module, making it easy to profile the execution of an entire program. Profiling can be enabled from the command line using the `-rprofile` option or from within a source program by requiring the profile module.

See also: [Benchmark](#) (page 636), [Profiler\\_\\_](#) (page 697)

```
require 'profile'
def ackerman(m, n)
 if m == 0 then n+1
 elsif n == 0 and m > 0 then ackerman(m-1, 1)
 else ackerman(m-1, ackerman(m, n-1))
 end
end
end
ackerman(3, 3)
```

*produces:*

%	cumulative	self		self	total	
time	seconds	seconds	calls	ms/call	ms/call	name
75.14	2.75	2.75	2432	1.13	46.92	Object#ackerman
13.39	3.24	0.49	3676	0.13	0.13	Fixnum#==
7.65	3.52	0.28	2431	0.12	0.12	Fixnum#-
3.83	3.66	0.14	1188	0.12	0.12	Fixnum#+
0.55	3.68	0.02	1	20.00	20.00	Profiler__.start_profile
0.00	3.68	0.00	1	0.00	0.00	Kernel.puts
0.00	3.68	0.00	1	0.00	0.00	Module#method_added
0.00	3.68	0.00	2	0.00	0.00	IO#write
0.00	3.68	0.00	57	0.00	0.00	Fixnum#>
0.00	3.68	0.00	1	0.00	3660.00	#toplevel

The Profiler\_\_ module can be used to collect a summary of the number of calls to, and the time spent in, methods in a Ruby program. The output is sorted by the total time spent in each method. The profile library is a convenience wrapper than profiles an entire program.

See also: Benchmark (page 636), profile (page 696)

```
require 'profiler'
Omit definition of connection and fetching methods
def calc_discount(qty, price)
 case qty
 when 0..10 then 0.0
 when 11..99 then price * 0.05
 else price * 0.1
 end
end
end
def calc_sales_totals(rows)
 total_qty = total_price = total_disc = 0
 rows.each do |row|
 total_qty += row.qty
 total_price += row.price
 total_disc += calc_discount(row.qty, row.price)
 end
end
end
connect_to_database
rows = read_sales_data
Profiler__::start_profile
calc_sales_totals(rows)
Profiler__::stop_profile
Profiler__::print_profile($stdout)
```

*produces:*

% time	cumulative seconds	self seconds	calls	self ms/call	total ms/call	name
31.19	0.34	0.34	1	340.00	1090.00	Array#each
20.18	0.56	0.22	648	0.34	0.80	Range#===
15.60	0.73	0.17	648	0.26	0.39	Fixnum#<=>
10.09	0.84	0.11	324	0.34	2.01	Object#calc_discount
6.42	0.91	0.07	648	0.11	0.11	Float#coerce
5.50	0.97	0.06	1296	0.05	0.05	Float#<=>
3.67	1.01	0.04	969	0.04	0.04	Float#+
2.75	1.04	0.03	648	0.05	0.05	S#price
2.75	1.07	0.03	648	0.05	0.05	S#qty
1.83	1.09	0.02	324	0.06	0.06	Float#*
0.92	1.10	0.01	1	10.00	10.00	Profiler__.start_profile
0.00	1.10	0.00	1	0.00	1090.00	#toplevel
0.00	1.10	0.00	1	0.00	1090.00	Object#calc_sales_totals
0.00	1.10	0.00	3	0.00	0.00	Fixnum#+

The PStore class provides transactional, file-based, persistent storage of Ruby objects. Each PStore can store several object hierarchies. Each hierarchy has a root, identified by a key (often a string). At the start of a PStore transaction, these hierarchies are read from a disk file and made available to the Ruby program. At the end of the transaction, the hierarchies are written back to the file. Any changes made to objects in these hierarchies are therefore saved on disk, to be read at the start of the next transaction that uses that file.

In normal use, a PStore object is created and then is used one or more times to control a transaction. Within the body of the transaction, any object hierarchies that had previously been saved are made available, and any changes to object hierarchies, and any new hierarchies, are written back to the file at the end.

- The following example stores two hierarchies in a PStore. The first, identified by the key "names", is an array of strings. The second, identified by "tree", is a simple binary tree.

```
require 'pstore'
require 'pp'
class T
 def initialize(val, left=nil, right=nil)
 @val, @left, @right = val, left, right
 end
 def to_a
 [@val, @left.to_a, @right.to_a]
 end
end
store = PStore.new("/tmp/store")
store.transaction do
 store['names'] = ['Douglas', 'Barenberg', 'Meyer']
 store['tree'] = T.new('top',
 T.new('A', T.new('B')),
 T.new('C', T.new('D', nil, T.new('E'))))
end
now read it back in
store.transaction do
 puts "Roots: #{store.roots.join(', ')}"
 puts store['names'].join(', ')
 pp store['tree'].to_a
end
produces:
Roots: names, tree
Douglas, Barenberg, Meyer
["top",
 ["A", ["B", [], [], []],
 ["C", ["D", [], ["E", [], []], []]]]
```

## Library **PTY** Pseudo-Terminal Interface: Interact with External Processes

Only if: Unix with  
pty support

Many Unix platforms support a *pseudo-terminal*—a device pair where one end emulates a process running on a conventional terminal, and the other end can read and write that terminal as if it were a user looking at a screen and typing on a keyboard.

The PTY library provides the method `spawn`, which starts the given command (by default a shell), connecting it to one end of a pseudo-terminal. It then returns the reader and writer streams connected to that terminal, allowing your process to interact with the running process.

Working with pseudo-terminals can be tricky. See `IO#expect` on page 655 for a convenience method that makes life easier. You might also want to track down Ara T. Howard’s `Session` module for an even simpler approach to driving subprocesses.<sup>4</sup>

See also: `expect` (page 655)

- Run `irb` in a subshell and ask it to convert the string “cat” to uppercase.

```
require 'pty'
require 'expect'
$expect_verbose = true
PTY.spawn("ruby /usr/local/bin/irb") do |reader, writer, pid|
 reader.expect(/irb.*:0> /)
 writer.puts "'cat'.upcase"
 reader.expect("=> ")
 answer = reader.gets
 puts "Answer = #{answer}"
end
```

*produces:*

```
irb(main):001:0> 'cat'.upcase
=> Answer = "CAT"
```

---

4. Currently found at <http://www.codeforpeople.com/lib/ruby/session/>.

Rational numbers are expressed as the ratio of two integers. When the denominator exactly divides the numerator, a rational number is effectively an integer. Rationals allow exact representation of fractional numbers, but some real values cannot be expressed exactly and so cannot be represented as rationals.

Class `Rational` is normally relatively independent of the other numeric classes, in that the result of dividing two integers will normally be a (truncated) integer. However, if the `mathn` library is loaded into a program, integer division may generate a `Rational` result.

See also: `mathn` (page 671), `Matrix` (page 673), `Complex` (page 641)

- Rational as a free-standing class.

```
require 'rational'
r1 = Rational(3, 4) → Rational(3, 4)
r2 = Rational(2, 3) → Rational(2, 3)
r1 * 2 → Rational(3, 2)
r1 * 8 → Rational(6, 1)
r1 / 6 → Rational(1, 8)
r1 * r2 → Rational(1, 2)
r1 + r2 → Rational(17, 12)
r1 ** r2 → 0.825481812223657
```

- Rational integrated with integers using `mathn`. Notice how `mathn` also changes the string representation of numbers.

```
require 'rational'
require 'mathn'
r1 = Rational(3, 4) → 3/4
r2 = Rational(2, 3) → 2/3
r1 * 2 → 3/2
r1 * 8 → 6
5/3 → 5/3
5/3 * 6 → 10
5/3 * 6/15 → 2/3
Math::sin(r1) → 0.681638760023334
```



Adds the method `readbytes` to class `IO`. This method will guarantee to read exactly the requested number of bytes from a stream, throwing either an `EOFError` at end of file or a `TruncatedDataError` if fewer than the requested number of bytes remain in the stream.

- Normally, `readbytes` would be used with a network connection. Here we illustrate its use with a regular file.

```
require 'readbytes'
File.open("testfile") do |f|
 begin
 loop do
 data = f.readbytes(10)
 p data
 end
 rescue EOFError
 puts "End of File"
 rescue TruncatedDataError => td
 puts "Truncated data: read '#{td.data.inspect}'"
 end
end
```

*produces:*

```
"This is li"
"ne one\nThi"
"s is line "
"two\nThis i"
"s line thr"
"ee\nAnd so "
Truncated data: read '"on...\n"'
```

Only if: GNU  
readline present

The Readline module allows programs to prompt for and receive lines of user input. The module allows lines to be edited during entry, and command history allows previous commands to be recalled and edited. The history can be searched, allowing the user to (for example) recall a previous command containing the text *ruby*. Command completion allows context-sensitive shortcuts: tokens can be expanded in the command line under control of the invoking application. In typical GNU fashion, the underlying readline library supports more options than any user could need and emulates both vi and emacs key bindings.

- This meaningless program implements a trivial interpreter that can increment and decrement a value. It uses the Abbrev module (described on page 634) to expand abbreviated commands when the tab key is pressed.

```
require 'readline'
include Readline
require 'abbrev'
COMMANDS = %w{ exit inc dec }
ABBREV = COMMANDS.abbrev
Readline.completion_proc = proc do |string|
 ABBREV[string]
end
value = 0
loop do
 cmd = readline("wibble [{value}]: ", true)
 break if cmd.nil?
 case cmd.strip
 when "exit"
 break
 when "inc"
 value += 1
 when "dec"
 value -= 1
 else
 puts "Invalid command #{cmd}"
 end
end

% ruby code/readline.rb
wibble [0]: inc
wibble [1]: <up-arrow> => inc
wibble [2]: d<tab> => dec
wibble [1]: ^r i => inc
wibble [2]: exit
%
```

The `resolv` library is a pure-Ruby implementation of a DNS client—it can be used to convert domain names into corresponding IP addresses. It also supports reverse lookups and the resolution of names in the local hosts file.

The `resolv` library exists to overcome a problem with the interaction of the standard operating system DNS lookup and the Ruby threading mechanism. On most operating system, name resolution is synchronous: you issue the call to look up a name, and the call returns when an address has been fetched. Because this lookup often involves network traffic, and because DNS servers can be slow, this call may take a (relatively) long time. During this time, the thread that issued the call is effectively suspended. Because Ruby does not use operating system threads, this means that the interpreter is effectively suspended while a DNS request is being executed from any running Ruby thread. This is sometimes unacceptable. Enter the `resolv` library. Because it is written in Ruby, it automatically participates in Ruby threading, and hence other Ruby threads can run while a DNS lookup is in progress in one thread.

Loading the additional library `resolv-replace` insinuates the `resolv` library into Ruby's socket library (see page 714).

- Use the standard socket library to look up a name. A counter running in a separate thread is suspended while this takes place.

```
require 'socket'

count = 0
Thread.critical = true
thread = Thread.new { Thread.pass; loop { count += 1; } }
IPSocket.getaddress("www.ruby-lang.org") → "210.251.121.210"
count → 0
```

- Repeat the experiment, but use the `resolv` library to allow Ruby's threading to work in parallel.

```
require 'socket'
require 'resolv-replace'

count = 0
Thread.critical = true
thread = Thread.new { Thread.pass; loop { count += 1; } }
IPSocket.getaddress("www.ruby-lang.org") → "210.251.121.210"
count → 39211
```

REXML is a pure-Ruby XML processing library, including DTD-compliant document parsing, XPath querying, and document generation. It supports both tree-based and stream-based document processing. As it is written in Ruby, it is available on all platforms supporting Ruby. REXML has a full and complex interface—this section contains a few small examples.

- Assume the file `demo.xml` contains

```
<classes language="ruby">
 <class name="Numeric">
 Numeric represents all numbers.
 <class name="Float">
 Floating point numbers have a fraction and a mantissa.
 </class>
 <class name="Integer">
 Integers contain exact integral values.
 <class name="Fixnum">
 Fixnums are stored as machine ints.
 </class>
 <class name="Bignum">
 Bignums store arbitraty-sized integers.
 </class>
</class>
</classes>
```

- Read and process the XML.

```
require 'rexml/document'
xml = REXML::Document.new(File.open("demo.xml"))
puts "Root element: #{xml.root.name}"
puts "\nThe names of all classes"
xml.elements.each("//class") {|c| puts c.attributes["name"]}
puts "\nThe description of Fixnum"
p xml.elements["//class[@name='Fixnum']").text
```

*produces:*

```
Root element: classes
```

```
The names of all classes
```

```
Numeric
Float
Integer
Fixnum
Bignum
```

```
The description of Fixnum
```

```
"\n Fixnums are stored as machine ints.\n "
```

- Read in a document, add and delete elements, and manipulate attributes before writing it back out.

```
require 'rexml/document'
include REXML

xml = Document.new(File.open("demo.xml"))
cls = Element.new("class")
cls.attributes["name"] = "Rational"
cls.text = "Represents complex numbers"
Remove Integer's children, and add our new node as
the one after Integer
int = xml.elements["//class[@name='Integer']"]
int.delete_at(1)
int.delete_at(2)
int.next_sibling = cls
Change all the 'name' attributes to class_name
xml.elements.each("//class") do |c|
 c.attributes['class_name'] = c.attributes['name']
 c.attributes.delete('name')
end
and write it out with a XML declaration at the front
xml << XMLDecl.new
xml.write(STDOUT, 0)
```

*produces:*

```
<?xml version='1.0'?>
<classes language='ruby'>
 <class class_name='Numeric'>
 Numeric represents all numbers.
 <class class_name='Float'>
 Floating point numbers have a fraction and a mantissa.
 </class>
 <class class_name='Integer'>
 Integers contain exact integral values.

 </class>
 <class class_name='Rational'>Represents complex numbers</class>
</class>
</classes>
```

Tuplespaces are a distributed blackboard system. Processes may add tuples to the blackboard, and other processes may remove tuples from the blackboard that match a certain pattern. Originally presented by David Gelernter, tuplespaces offer an interesting scheme for distributed cooperation among heterogeneous processes.

Rinda, the Ruby implementation of tuplespaces, offers some interesting additions to the concept. In particular, the Rinda implementation uses the `===` operator to match tuples. This means that tuples may be matched using regular expressions, the classes of their elements, as well as the element values.

See also: DRb (page 649)

- The blackboard is a DRb server that offers a shared tuplespace.

```
require 'drb/drb'
require 'rinda/tuplespace'
require 'my_uri' # Defines the constant MY_URI
DRb.start_service(MY_URI, Rinda::TupleSpace.new)
DRb.thread.join
```

- The arithmetic agent accepts messages containing an arithmetic operator and two numbers. It stores the result back on the blackboard.

```
require 'drb/drb'
require 'rinda/rinda'
require 'my_uri'
DRb.start_service
ts = Rinda::TupleSpaceProxy.new(DRbObject.new(nil, MY_URI))
loop do
 op, v1, v2 = ts.take([%r{^[+/*]$}, Numeric, Numeric])
 ts.write(["result", v1.send(op, v2)])
end
```

- The client places a sequence of tuples on the blackboard and reads back the result of each.

```
require 'drb/drb'
require 'rinda/rinda'
require 'my_uri'
DRb.start_service
ts = Rinda::TupleSpaceProxy.new(DRbObject.new(nil, MY_URI))
queries = [["+", 1, 2], ["*", 3, 4], ["/", 8, 2]]
queries.each do |q|
 ts.write(q)
 ans = ts.take(["result", nil])
 puts "#{q[1]} #{q[0]} #{q[2]} = #{ans[1]}"
end
```

Rich (or RDF) Site Summary, Really Simple Syndication, take your pick. RSS is the protocol of choice for disseminating news on the Internet. The Ruby RSS library supports creating and parsing streams compliant with the RSS 0.9, RSS 1.0, and RSS 2.0 specifications.

- Read and summarize the latest stories from <http://ruby-lang.org>.

```
require 'rss/1.0'
require 'open-uri'
open('http://ruby-lang.org/en/index.rdf') do |http|
 response = http.read
 result = RSS::Parser.parse(response, false)
 puts "Channel: " + result.channel.title
 result.items.each_with_index do |item, i|
 puts "#{i+1}. #{item.title}" if i < 4
 end
end
```

*produces:*

```
Channel: Ruby Home Page
1. Brad Cox to keynote RubyConf 2004
2. Download Ruby
3. RubyConf 2004 registration now open
4. ruby 1.8.2 preview1 released
```

- Generate some RSS information.

```
require 'rss/0.9'
rss = RSS::Rss.new("0.9")
chan = RSS::Rss::Channel.new
chan.description = "Dave's Feed"
chan.link = "http://pragprog.com/pragdave"
rss.channel = chan
image = RSS::Rss::Channel::Image.new
image.url = "http://pragprog.com/pragdave.gif"
image.title = "PragDave"
image.link = chan.link
chan.image = image
3.times do |i|
 item = RSS::Rss::Channel::Item.new
 item.title = "My News Number #{i}"
 item.link = "http://pragprog.com/pragdave/story_#{i}"
 item.description = "This is a story about number #{i}"
 chan.items << item
end
puts rss.to_s
```

Library **Scanf**

## Input Format Conversion

Implements a version of the C library `scanf` function, which extracts values from a string under the control of a format specifier.

The Ruby version of the library adds a `scanf` method to both class `IO` and class `String`. The version in `IO` applies the format string to the next line read from the receiver. The version in `String` applies the format string to the receiver. The library also adds the global method `Kernel.scanf`, which uses as its source the next line of standard input.

`Scanf` has one main advantage over using regular expressions to break apart a string: a regular expression extracts strings whereas `scanf` will return objects converted to the correct type.

- Split a date string into its constituents.

```
require 'scanf'

date = "2004-12-15"
year, month, day = date.scanf("%4d-%2d-%2d")
year → 2004
month → 12
day → 15
year.class → Fixnum
```

- The block form of `scanf` applies the format multiple times to the input string, returning each set of results to the block.

```
require 'scanf'
data = "cat:7 dog:9 cow:17 walrus:31"
data.scanf("%[^:]:%d ") do |animal, value|
 puts "A #{animal.strip} has #{value*1.4}"
end
```

*produces:*

```
A cat has 9.8
A dog has 12.6
A cow has 23.8
A walrus has 43.4
```

- Extract hex numbers.

```
require 'scanf'

data = "decaf bad"
data.scanf("%3x%2x%x") → [3564, 175, 2989]
```



The SDBM database implements a simple key/value persistence mechanism. Because the underlying SDBM library itself is provided with Ruby, there are no external dependencies, and SDBM should be available on all platforms supported by Ruby. SDBM database keys and values must be strings. SDBM databases are effectively hashlike.

See also: DBM (page 645), GDBM (page 661)

- Store a record in a new database, and then fetch it back. Unlike the DBM library, all values to SDBM must be strings (or implement `to_str`).

```
require 'sdbm'
require 'date'

SDBM.open("data.dbm") do |dbm|
 dbm['name'] = "Walter Wombat"
 dbm['dob'] = Date.new(1997, 12,25).to_s
 dbm['uses'] = "Ruby"
end

SDBM.open("data.dbm", nil) do |dbm|
 p dbm.keys
 p dbm['dob']
 p dbm['dob'].class
end
```

*produces:*

```
["name", "dob", "uses"]
"1997-12-25"
String
```

Library **Set**

## Implement Various Forms of Set

A Set is a collection of unique values (where uniqueness is determined using eql? and hash). Convenience methods let you build sets from enumerable objects.

- Basic set operations.

```
require 'set'

set1 = Set.new([:bear, :cat, :deer])

set1.include?(:bat) → false
set1.add(:fox) → #<Set: {:cat, :deer, :fox, :bear}>

partition = set1.classify {|element| element.to_s.length }

partition → {3=>#<Set: {:cat, :fox}>, 4=>#<Set: {:deer, :bear}>}

set2 = [:cat, :dog, :cow].to_set
set1 | set2 → #<Set: {:cat, :dog, :deer, :cow, :fox, :bear}>
set1 & set2 → #<Set: {:cat}>
set1 - set2 → #<Set: {:deer, :fox, :bear}>
set1 ^ set2 → #<Set: {:dog, :deer, :cow, :fox, :bear}>
```

- Partition the users in our /etc/passwd file into subsets where members of each subset have adjacent user IDs.

```
require 'etc'
require 'set'

users = []
Etc.passwd {|u| users << u }
related_users = users.to_set.divide do |u1, u2|
 (u1.uid - u2.uid).abs <= 1
end
related_users.each do |relatives|
 relatives.each {|u| print "#{u.uid}/#{u.name} " }
 puts
end
```

*produces:*

```
75/sshd 79/appserver 78/mailman 77/cyrus 76/qtss 74/mysql
503/testuser 502/dave
27/postfix 25/smmisp 26/lp
70/www 71/eppc
99/unknown
-2/nobody
1/daemon 0/root
```

## Library **Shellwords** Split Line into Words Using POSIX Semantics

Given a string representative of a shell command line, split it into word tokens according to POSIX semantics.

- Spaces between double or single quotes are treated as part of a word.
- Double quotes may be escaped using a backslash.
- Spaces escaped by a backslash are not used to separate words.
- Otherwise tokens separated by whitespace are treated as words.

```
require 'shellwords'
include Shellwords

line = %Code Ruby, Be Happy!
shellwords(line) → ["Code", "Ruby,", "Be", "Happy!"]

line = %"Code Ruby", 'Be Happy'!
shellwords(line) → ["Code Ruby,", "Be Happy'!"]

line = %qCode\ Ruby, \"Be Happy\"!
shellwords(line) → ["Code Ruby,", "\"Be", "Happy\"!"]
```

**Library** **Singleton****The Singleton Pattern**

The Singleton design pattern ensures that only one instance of a particular class may be created for the lifetime of a program (see *Design Patterns* [GHJV95]).

The `singleton` library makes this simple to implement. Mix the `Singleton` module into each class that is to be a singleton, and that class's `new` method will be made private. In its place, users of the class call the method `instance`, which returns a singleton instance of that class.

In this example, the two instances of `MyClass` are the same object.

```
require 'singleton'

class MyClass

 attr_accessor :data
 include Singleton
end

a = MyClass.instance → #<MyClass:0x1c20dc>
b = MyClass.instance → #<MyClass:0x1c20dc>

a.data = 123 → 123
b.data → 123
```

The SOAP library implements both the client and server sides of the SOAP protocol, including support for WSDL, the Web Services Description Language.

A fuller discussion of the SOAP library, including some examples of accessing the Google search API, starts on page [236](#).

- Create a simple SOAP service that returns the current local time as a string.

```
require 'soap/rpc/standaloneServer'
module TimeServant
 def TimeServant.now
 Time.now.to_s
 end
end
class Server < SOAP::RPC::StandaloneServer
 def on_init
 servant = TimeServant
 add_method(servant, 'now')
 end
end
if __FILE__ == $0
 svr = Server.new('Server',
 'http://pragprog.com/TimeServer',
 '0.0.0.0',
 12321)
 trap('INT') { svr.shutdown }
 svr.start
end
```

- Query the server using a simple SOAP client.

```
require 'soap/rpc/driver'
proxy = SOAP::RPC::Driver.new("http://localhost:12321",
 "http://pragprog.com/TimeServer")
proxy.add_method("now")
p proxy.now
produces:
"Thu Aug 26 22:39:14 CDT 2004"
```

The `socket` extension defines nine classes for accessing the socket-level communications of the underlying system. All of these classes are (indirect) subclasses of class `IO`, meaning that `IO`'s methods can be used with socket connections.

The hierarchy of socket classes reflects the reality of network programming and hence is somewhat confusing. The `BasicSocket` class largely contains methods common to data transfer for all socket-based connections. It is subclassed to provide protocol-specific implementations: `IPSocket`, `UNIXSocket` (for domain sockets), and (indirectly) `TCPsocket`, `UDPSocket`, and `SOCKSSocket`.

`BasicSocket` is also subclassed by class `Socket`, which is a more generic interface to socket-oriented networking. While classes such as `TCPsocket` are specific to a protocol, `Socket` objects can, with some work, be used regardless of protocol.

`TCPsocket`, `SOCKSSocket`, and `UNIXSocket` are each connection oriented. Each has a corresponding `xxxxServer` class, which implements the server end of a connection.

The socket libraries are something that you may never use directly. However, if you do use them, you'll need to know the details. For that reason, we've included a reference section covering the socket library methods in Appendix A on page 740.

The following code shows a trivial UDP server and client. For more examples see Appendix A.

```
Simple logger prints messages
received on UDP port 12121
require 'socket'
socket = UDPSocket.new
socket.bind("127.0.0.1", 12121)
loop do
 msg, sender = socket.recvfrom(100)
 host = sender[3]
 puts "#{Time.now}: #{host} '#{msg}'"
end

Exercise the logger
require 'socket'
log = UDPSocket.new
log.connect("127.0.0.1", 12121)
log.print "Up and Running!"
process ... process ..
log.print "Done!"
```

*This produces:*

```
Wed Jun 30 17:30:24 CDT 2004: 127.0.0.1 'Up and Running!'
Wed Jun 30 17:30:24 CDT 2004: 127.0.0.1 'Done!'
```

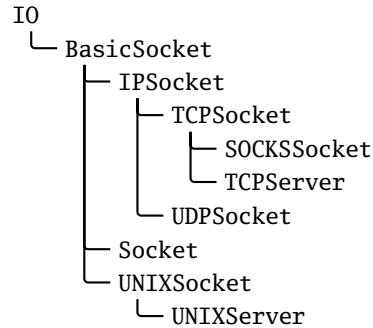

Library **StringIO**

## Treat Strings as IO Objects

In some ways the distinction between strings and file contents is artificial: the contents of a file is basically a string that happens to live on disk, not in memory. The StringIO library aims to unify the two concepts, making strings act as if they were opened IO objects. Once a string is wrapped in a StringIO object, it can be read from and written to as if it were an open file. This can make unit testing a lot easier. It also lets you pass strings into classes and methods that were originally written to work with files.

- Read and write from a string.

```
require 'stringio'

sio = StringIO.new("time flies like an arrow")

sio.read(5) → "time "
sio.read(5) → "flies"
sio.pos = 18
sio.read(5) → " arro"
sio.rewind → 0
sio.write("fruit") → 5
sio.pos = 16
sio.write("a banana") → 8
sio.rewind → 0
sio.read → "fruitflies like a banana"
```

- Use StringIO as a testing aid.

```
require 'stringio'
require 'csv'
require 'test/unit'

class TestCSV < Test::Unit::TestCase
 def test_simple
 StringIO.open do |op|
 CSV::Writer.generate(op) do |csv|
 csv << [1, "line 1", 27]
 csv << [2, nil, 123]
 end
 assert_equal("1,line 1,27\n2,,123\n", op.string)
 end
 end
end

produces:
Loaded suite -
Started
.
Finished in 0.001857 seconds.

1 tests, 1 assertions, 0 failures, 0 errors
```

StringScanner objects progress through a string, matching (and optionally returning) tokens that match a given pattern. Unlike the built-in scan methods, StringScanner objects maintain a current position pointer in the string being examined, so each call resumes from the position in the string where the previous call left off. Pattern matches are anchored to this previous point.

- Implement a simple language.

```
require 'strscan'
Handle the language:
set <var> = <value>
get <var>
values = {}
loop do
 line = gets or break
 scanner = StringScanner.new(line.chomp)
 scanner.scan(/(get|set)\s+/) or fail "Missing command"
 cmd = scanner[1]
 var_name = scanner.scan(/\w+/) or fail "Missing variable"
 case cmd
 when "get"
 puts "#{var_name} => #{values[var_name].inspect}"
 when "set"
 scanner.skip(/\s+=\s+/) or fail "Missing '='"
 value = scanner.rest
 values[var_name] = value
 else
 fail cmd
 end
end
```

*produces:*

```
% ruby code/strscan.rb
set a = dave
set b = hello
get b
b => "hello"
get a
a => "dave"
```



The sync library synchronizes the access to shared data across multiple, concurrent threads. Unlike Monitor, the sync library supports both exclusive access to data and shared (read-only) access.

See also: Monitor (page 674), Mutex (page 675), Thread (page 612)

- Without synchronization, the following code has a race condition: the `inc` method can be interrupted between fetching the count and storing the incremented value back, resulting in updates being lost.

```
require 'thwait'

class Counter
 attr_reader :total_count
 def initialize
 @total_count = 0
 end
 def inc
 @total_count += 1
 end
end

count = Counter.new
waiter = ThreadWait.new([])

create 10 threads that each inc() 10,000 times
10.times do
 waiter.join_nowait(Thread.new { 10000.times { count.inc } })
end

waiter.all_waits
count.total_count → 62449
```

- Add exclusive synchronization to ensure the count is correct.

```
require 'thwait'
require 'sync'

class Counter
 attr_reader :total_count
 def initialize
 @total_count = 0
 @sync = Sync.new
 end
 def inc
 @sync.synchronize(:EX) do
 @total_count += 1
 end
 end
end
```

```

count = Counter.new
waiter = ThreadWait.new([])

create 10 threads that each inc() 10,000 times
10.times do
 waiter.join_nowait(Thread.new { 10000.times { count.inc } })
end

waiter.all_waits → nil
count.total_count → 100000

```

- Add shared region to ensure that readers get consistent picture.

```

require 'thwait'
require 'sync'

class Counter
 attr_reader :total_count
 def initialize
 @total_count = 0
 @count_down = 0
 @sync = Sync.new
 end
 def inc
 @sync.synchronize(:EX) do
 @total_count += 1
 @count_down -= 1
 end
 end
 def test_consistent
 @sync.synchronize(:SH) do
 fail "Bad counts" unless @total_count + @count_down == 0
 end
 end
end

count = Counter.new
waiter = ThreadWait.new([])

create 10 threads that each inc() 10,000 times
10.times do
 waiter.join_nowait(Thread.new { 10000.times do
 count.inc
 count.test_consistent
 end })
end

waiter.all_waits → nil
count.total_count → 100000

```

Only if: Unix  
system with syslog

The Syslog class is a simple wrapper around the Unix syslog(3) library. It allows messages to be written at various severity levels to the logging daemon, where they are disseminated according to the configuration in `syslog.conf`. The following examples assume the log file is `/var/log/system.log`.

- Add to our local system log. We'll log all the levels configured for the user facility for our system (which is every level except debug messages).

```
require 'syslog'
log = Syslog.open("test") # "test" is the app name
log.debug("Warm and fuzzy greetings from your program")
log.info("Program starting")
log.notice("I said 'Hello!'")
log.warning("If you don't respond soon, I'm quitting")
log.err("You haven't responded after %d milliseconds", 7)
log.alert("I'm telling your mother...")
log.emerg("I'm feeling totally crushed")
log.crit("Aarrgh....")

system("tail -7 /var/log/system.log")
```

*produces:*

```
Aug 26 22:39:38 wireless_2 test[28505]: Program starting
Aug 26 22:39:38 wireless_2 test[28505]: I said 'Hello!'
Aug 26 22:39:38 wireless_2 test[28505]: If you don't respond soon, I'm quitting
Aug 26 22:39:38 wireless_2 test[28505]: You haven't responded after 7 milliseconds
Aug 26 22:39:38 wireless_2 test[28505]: I'm telling your mother...
Aug 26 22:39:38 wireless_2 test[28505]: I'm feeling totally crushed
Aug 26 22:39:38 wireless_2 test[28505]: Aarrgh....
```

- Only log errors and above.

```
require 'syslog'
log = Syslog.open("test")
log.mask = Syslog::LOG_UPTO(Syslog::LOG_ERR)
log.debug("Warm and fuzzy greetings from your program")
log.info("Program starting")
log.notice("I said 'Hello!'")
log.warning("If you don't respond soon, I'm quitting")
log.err("You haven't responded after %d milliseconds", 7)
log.alert("I'm telling your mother...")
log.emerg("I'm feeling totally crushed")
log.crit("Aarrgh....")

system("tail -7 /var/log/system.log")
```

*produces:*

```
Aug 26 22:39:38 wireless_2 test[28510]: You haven't responded after 7 milliseconds
Aug 26 22:39:38 wireless_2 test[28510]: I'm telling your mother...
Aug 26 22:39:38 wireless_2 test[28510]: I'm feeling totally crushed
Aug 26 22:39:38 wireless_2 test[28510]: Aarrgh....
```

Class `Tempfile` creates managed temporary files. Although they behave the same as any other IO objects, temporary files are automatically deleted when the Ruby program terminates. Once a `Tempfile` object has been created, the underlying file may be opened and closed a number of times in succession.

`Tempfile` does not directly inherit from `IO`. Instead, it delegates calls to a `File` object. From the programmer's perspective, apart from the unusual `new`, `open`, and `close` semantics, a `Tempfile` object behaves as if it were an `IO` object.

If you don't specify a directory to hold temporary files when you create them, the `tmpdir` library will be used to find a system-dependent location.

See also: `tmpdir` (page 727)

```
require 'tempfile'
```

```
tf = Tempfile.new("afile")
tf.path → "/tmp/afile28519.0"
tf.puts("Cosi Fan Tutte") → nil
tf.close → nil
tf.open → #<File:/tmp/afile28519.0>
tf.gets → "Cosi Fan Tutte\n"
tf.close(true) → #<File:/tmp/afile28519.0 (closed)>
```

Test::Unit is a unit testing framework based on the original SUnit Smalltalk framework. It provides a structure in which unit tests may be organized, selected, and run. Tests can be run from the command line or using one of several GUI-based interfaces.

Chapter 12 on page 143 contains a tutorial on Test::Unit.

We could have a simple playlist class, designed to store and retrieve songs.

```
require 'code/testunit/song.rb'
require 'forwardable'

class Playlist
 extend Forwardable
 def_delegator(:@list, :<<, :add_song)
 def_delegator(:@list, :size)

 def initialize
 @list = []
 end

 def find(title)
 @list.find {|song| song.title == title}
 end
end
```

We can write unit tests to exercise this class. The Test::Unit framework is smart enough to run the tests in a test class if no main program is supplied.

```
require 'test/unit'
require 'code/testunit/playlist.rb'

class TestPlaylist < Test::Unit::TestCase
 def test_adding
 pl = Playlist.new
 assert_equal(0, pl.size)
 assert_nil(pl.find("My Way"))
 pl.add_song(Song.new("My Way", "Sinatra"))
 assert_equal(1, pl.size)
 s = pl.find("My Way")
 assert_not_nil(s)
 assert_equal("Sinatra", s.artist)
 assert_nil(pl.find("Chicago"))
 # .. and so on
 end
end
```

*produces:*

```
Loaded suite -
Started
.
Finished in 0.002046 seconds.
```

```
1 tests, 6 assertions, 0 failures, 0 errors
```

Library **thread**

## Utility Functionality for Threading

The `thread` library adds some utility functions and classes for supporting threads. Much of this has been superseded by the `Monitor` class, but it contains two classes, `Queue` and `SizedQueue`, that are still useful. Both classes implement a thread-safe queue that can be used to pass objects between producers and consumers in multiple threads. The `Queue` object implements a unbounded queue. A `SizedQueue` is told its capacity; any producer who tries to add an object when the queue is at that capacity will block until a consumer has removed an object.

- The following example was provided by Robert Kellner. It has three consumers taking objects from an un-sized queue. Those objects are provided by two producers, which each add three items.

```
require 'thread'
queue = Queue.new

consumers = (1..3).map do |i|
 Thread.new("consumer #{i}") do |name|
 begin
 obj = queue.deq
 print "#{name}: consumed #{obj.inspect}\n"
 sleep(rand(0.05))
 end until obj == :END_OF_WORK
 end
end

producers = (1..2).map do |i|
 Thread.new("producer #{i}") do |name|
 3.times do |j|
 sleep(0.1)
 queue.enq("Item #{j} from #{name}")
 end
 end
end

producers.each {|th| th.join}
consumers.size.times { queue.enq(:END_OF_WORK) }
consumers.each {|th| th.join}
```

*produces:*

```
consumer 1: consumed "Item 0 from producer 1"
consumer 2: consumed "Item 0 from producer 2"
consumer 3: consumed "Item 1 from producer 1"
consumer 3: consumed "Item 1 from producer 2"
consumer 3: consumed "Item 2 from producer 2"
consumer 2: consumed "Item 2 from producer 1"
consumer 3: consumed :END_OF_WORK
consumer 2: consumed :END_OF_WORK
consumer 1: consumed :END_OF_WORK
```

Class `ThreadsWait` handles the termination of a group of thread objects. It provides methods to allow you to check for termination of any managed thread and to wait for all managed threads to terminate.

The following example kicks off a number of threads that each wait for a slightly shorter length of time before terminating and returning their thread number. Using `ThreadsWait`, we can capture these threads as they terminate, either individually or as a group.

```
require 'thwait'

group = ThreadsWait.new

construct 10 threads that wait for 1 second, .9 second, etc.
add each to the group

9.times do |i|
 thread = Thread.new(i) { |index| sleep 1.0 - index/10.0; index }
 group.join_nowait(thread)
end

any threads finished?
group.finished? → false

wait for one to finish
group.next_wait.value → 8

wait for 5 more to finish
5.times { group.next_wait } → 5

wait for next one to finish
group.next_wait.value → 2

and then wait for all the rest
group.all_waits → nil
```

The `time` library adds functionality to the built-in class `Time`, supporting date and/or time formats used by RFC 2882 (e-mail), RFC 2616 (HTTP), and ISO 8601 (the subset used by XML schema).

```
require 'time'
Time.rfc2822("Thu, 1 Apr 2004 16:32:45 CST")
 → Thu Apr 01 16:32:45 CST 2004

Time.rfc2822("Thu, 1 Apr 2004 16:32:45 -0600")
 → Thu Apr 01 16:32:45 CST 2004

Time.now.rfc2822
 → Thu, 26 Aug 2004 22:39:42 -0500

Time.httpdate("Thu, 01 Apr 2004 16:32:45 GMT")
 → Thu Apr 01 16:32:45 UTC 2004

Time.httpdate("Thursday, 01-Apr-04 16:32:45 GMT")
 → Thu Apr 01 16:32:45 UTC 2004

Time.httpdate("Thu Apr 1 16:32:45 2004")
 → Thu Apr 01 16:32:45 UTC 2004

Time.now.httpdate
 → Fri, 27 Aug 2004 03:39:42 GMT

Time.xmlschema("2004-04-01T16:32:45")
 → Thu Apr 01 16:32:45 CST 2004

Time.xmlschema("2004-04-01T16:32:45.12-06:00")
 → Thu Apr 01 22:32:45 UTC 2004

Time.now.xmlschema
 → 2004-08-26T22:39:42-05:00
```



The `Timeout.timeout` method takes a parameter representing a timeout period in seconds, an optional exception parameter, and a block. The block is executed, and a timer is run concurrently. If the block terminates before the timeout, `timeout` returns the value of the block. Otherwise, the exception (default `Timeout::Error`) is raised.

```
require 'timeout'
for snooze in 1..2
 puts "About to sleep for #{snooze}"
 begin
 Timeout::timeout(1.5) do |timeout_length|
 puts "Timeout period is #{timeout_length}"
 sleep(snooze)
 puts "That was refreshing"
 end
 rescue Timeout::Error
 puts "Woken up early!!"
 end
end
```

*produces:*

```
About to sleep for 1
Timeout period is 1.5
That was refreshing
About to sleep for 2
Timeout period is 1.5
Woken up early!!
```

Library **Tk**

## Wrapper for Tcl/Tk

Only if: Tk library  
installed

Of all the Ruby options for creating GUIs, the Tk library is probably the most widely supported, running on Windows, Linux, Mac OS X, and other Unix-like platforms.<sup>5</sup> Although it doesn't produce the prettiest interfaces, Tk is functional and relatively simple to program. The Tk extension is documented more fully in Chapter 19 on page 241.

```
require 'tk'
include Math

TkRoot.new do |root|
 title "Curves"
 geometry "400x400"
 TkCanvas.new(root) do |canvas|
 width 400
 height 400
 pack('side'=>'top', 'fill'=>'both', 'expand'=>'yes')
 points = []
 10.upto(30) do |scale|
 (0.0).step(2*PI,0.1) do |i|
 new_x = 5*scale*sin(i) + 200 + scale*sin(i*2)
 new_y = 5*scale*cos(i) + 200 + scale*cos(i*6)
 points << [new_x, new_y]
 f = scale/5.0
 r = (Math.sin(f)+1)*127.0
 g = (Math.cos(2*f)+1)*127.0
 b = (Math.sin(3*f)+1)*127.0
 col = sprintf("#%02x%02x%02x", r.to_i, g.to_i, b.to_i)
 if points.size == 3
 TkLine.new(canvas,
 points[0][0], points[0][1],
 points[1][0], points[1][1],
 points[2][0], points[2][1],
 'smooth'=>'on',
 'width'=> 7,
 'fill' => col,
 'capstyle' => 'round')
 points.shift
 end
 end
 end
 end
end
Tk.mainloop
```

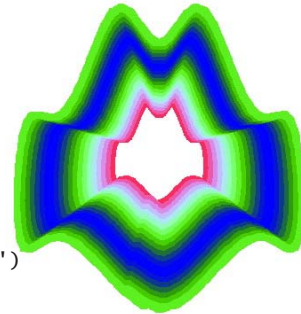

5. Although all these environments require that the Tcl/Tk libraries are installed before the Ruby Tk extension can be used.

Library

**tmpdir**

## System-Independent Temporary Directory Location

The `tmpdir` library adds the `tmpdir` method to class `Dir`. This method returns the path to a temporary directory that *should* be writable by the current process. (This will not be true if none of the well-known temporary directories is writable, and if the current working directory is also not writable.) Candidate directories include those referenced by the environment variables `TMPDIR`, `TMP`, `TEMP`, and `USERPROFILE`, the directory `/tmp`, and (on Windows boxes) the `temp` subdirectory of the Windows or System directory.

```
require 'tmpdir'
```

```
Dir.tmpdir → "/tmp"
```

```
ENV['TMPDIR'] = "/wibble" # doesn't exist
ENV['TMP'] = "/sbin" # not writable
ENV['TEMP'] = "/Users/dave/tmp" # just right
```

```
Dir.tmpdir → "/Users/dave/tmp"
```

Library **Tracer**

## Trace Program Execution

The tracer library uses `Kernel.set_trace_func` to trace all or part of a Ruby program's execution. The traced lines show the thread number, file, line number, class, event, and source line. The events shown are “-” for a change of line, “>” for a call, “<” for a return, “C” for a class definition, and “E” for the end of a definition.

- You can trace an entire program by including the tracer library from the command line.

```
class Account
 def initialize(balance)
 @balance = balance
 end
 def debit(amt)
 if @balance < amt
 fail "Insufficient funds"
 else
 @balance -= amt
 end
 end
end
acct = Account.new(100)
acct.debit(40)
```

```
% ruby -r tracer account.rb
#0:account.rb:1: -: class Account
#0:account.rb:1:Class:>: class Account
#0:account.rb:1:Class:<: class Account
#0:account.rb:1:C: class Account
#0:account.rb:2: -: def initialize(balance)
#0:account.rb:2:Module:>: def initialize(balance)
#0:account.rb:2:Module:<: def initialize(balance)
#0:account.rb:5: -: def debit(amt)
#0:account.rb:5:Module:>: def debit(amt)
#0:account.rb:5:Module:<: def debit(amt)
#0:account.rb:1:E: class Account
#0:account.rb:13: -: acct = Account.new(100)
#0:account.rb:13:Class:>: acct = Account.new(100)
#0:account.rb:2:Account:>: def initialize(balance)
#0:account.rb:3:Account: -: @balance = balance
#0:account.rb:13:Account:<: acct = Account.new(100)
#0:account.rb:13:Class:<: acct = Account.new(100)
#0:account.rb:14: -: acct.debit(40)
#0:account.rb:5:Account:>: def debit(amt)
#0:account.rb:6:Account: -: if @balance < amt
#0:account.rb:6:Account: -: if @balance < amt
#0:account.rb:6:Fixnum:>: if @balance < amt
#0:account.rb:6:Fixnum:<: if @balance < amt
#0:account.rb:9:Account: -: @balance -= amt
#0:account.rb:9:Fixnum:>: @balance -= amt
#0:account.rb:9:Fixnum:<: @balance -= amt
#0:account.rb:9:Account:<: @balance -= amt
```

- You can also use tracer objects to trace just a portion of your code and use filters to select what to trace.

```
require 'tracer'

class Account
 def initialize(balance)
 @balance = balance
 end
 def debit(amt)
 if @balance < amt
 fail "Insufficient funds"
 else
 @balance -= amt
 end
 end
end

tracer = Tracer.new
tracer.add_filter lambda {|event, *rest| event == "line" }
acct = Account.new(100)
tracer.on do
 acct.debit(40)
end
```

```
#0:account.rb:20: -: acct.debit(40)
#0:account.rb:8:Account: -: if @balance < amt
#0:account.rb:8:Account: -: if @balance < amt
#0:account.rb:11:Account: -: @balance -= amt
```

Given a set of dependencies between nodes (where each node depends on zero or more other nodes, and there are no cycles in the graph of dependencies), a topological sort will return a list of the nodes ordered such that no node follows a node that depends on it. One use for this is scheduling tasks, where the order means that you will complete the dependencies before you start any task that depends on them. The make program uses a topological sort to order its execution.

In this library's implementation, you mix in the TSort module and define two methods: `tsort_each_node`, which yields each node in turn, and `tsort_each_child`, which, given a node, yields each of that nodes dependencies.

- Given the set of dependencies among the steps for making a piña colada, what is the optimum order for undertaking the steps?

```
require 'tsort'
class Tasks
 include TSort
 def initialize
 @dependencies = {}
 end
 def add_dependency(task, *relies_on)
 @dependencies[task] = relies_on
 end
 def tsort_each_node(&block)
 @dependencies.each_key(&block)
 end
 def tsort_each_child(node, &block)
 deps = @dependencies[node]
 deps.each(&block) if deps
 end
end
tasks = Tasks.new
tasks.add_dependency(:add_rum, :open_blender)
tasks.add_dependency(:add_pc_mix, :open_blender)
tasks.add_dependency(:add_ice, :open_blender)
tasks.add_dependency(:close_blender, :add_rum, :add_pc_mix, :add_ice)
tasks.add_dependency(:blend_mix, :close_blender)
tasks.add_dependency(:pour_drink, :blend_mix)
tasks.add_dependency(:pour_drink, :open_blender)
puts tasks.tsort
```

*produces:*

```
open_blender
add_pc_mix
add_ice
add_rum
close_blender
blend_mix
pour_drink
```

Why un? Because when you invoke it from the command line with the `-r` option to Ruby, it spells `-run`. This pun gives a hint as to the intent of the library: it lets you run commands (in this case, a subset of the methods in `FileUtils`) from the command line. In theory this gives you an operating system-independent set of file manipulation commands, possibly useful when writing portable Makefiles.

See also: `FileUtils` (page 657)

- The available commands are

```
% ruby -run -e cp -- <options> source dest
% ruby -run -e ln -- <options> target linkname
% ruby -run -e mv -- <options> source dest
% ruby -run -e rm -- <options> file
% ruby -run -e mkdir -- <options> dirs
% ruby -run -e rmdir -- <options> dirs
% ruby -run -e install -- <options> source dest
% ruby -run -e chmod -- <options> octal_mode file
% ruby -run -e touch -- <options> file
```

Note the use of `--` to tell the Ruby interpreter that options to the program follow.

You can get a list of all available commands with

```
% ruby -run -e help
```

For help on a particular command, append the command's name.

```
% ruby -run -e help mkdir
```

URI encapsulates the concept of a Uniform Resource Identifier (URI), a way of specifying some kind of (potentially networked) resource. URIs are a superset of URLs: URLs (such as the addresses of Web pages) allow specification of addresses by location, and URIs also allow specification by name.

URIs consist of a scheme (such as `http`, `mailto`, `ftp`, and so on), followed by structured data identifying the resource within the scheme.

URI has factory methods that take a URI string and return a subclass of URI specific to the scheme. The library explicitly supports the `ftp`, `http`, `https`, `ldap`, and `mailto` schemes; others will be treated as generic URIs. The module also has convenience methods to escape and unescape URIs. The class `Net::HTTP` accepts URI objects where a URL parameter is expected.

See also: `open-uri` (page 686), `Net::HTTP` (page 678)

```
require 'uri'
```

```
uri = URI.parse("http://pragprog.com:1234/mypage.cgi?q=ruby")
uri.class → URI::HTTP
uri.scheme → "http"
uri.host → "pragprog.com"
uri.port → 1234
uri.path → "/mypage.cgi"
uri.query → "q=ruby"
```

```
uri = URI.parse("mailto:ruby@pragprog.com?Subject=help&body=info")
uri.class → URI::MailTo
uri.scheme → "mailto"
uri.to → "ruby@pragprog.com"
uri.headers → [["Subject", "help"], ["body", "info"]]
```

```
uri = URI.parse("ftp://dave@anon.com:/pub/ruby?type=i")
uri.class → URI::FTP
uri.scheme → "ftp"
uri.host → "anon.com"
uri.port → 21
uri.path → "/pub/ruby"
uri.typecode → "i"
```

In Ruby, objects are not eligible for garbage collection if references still exist to them. Normally, this is a Good Thing—it would be disconcerting to have an object simply evaporate while you were using it. However, sometimes you may need more flexibility. For example, you might want to implement an in-memory cache of commonly used file contents. As you read more files, the cache grows. At some point, you may run low on memory. The garbage collector will be invoked, but the objects in the cache are all referenced by the cache data structures and so will not be deleted.

A weak reference behaves exactly as any normal object reference with one important exception—the referenced object may be garbage collected, even while references to it exist. In the cache example, if the cached files were accessed using weak references, once memory runs low they will be garbage collected, freeing memory for the rest of the application.

- Weak references introduce a slight complexity. As the object referenced can be deleted by garbage collection at any time, code that accesses these objects must take care to ensure that the references are valid. Two techniques can be used. First, the code can reference the objects normally. Any attempt to reference an object that has been garbage collected will raise a `WeakRef::RefError` exception.

```
require 'weakref'
ref = "fol de rol"
puts "Initial object is #{ref}"
ref = WeakRef.new(ref)
puts "Weak reference is #{ref}"
ObjectSpace.garbage_collect
puts "But then it is #{ref}"
```

*produces:*

```
Initial object is fol de rol
Weak reference is fol de rol
prog.rb:8: Illegal Reference - probably recycled (WeakRef::RefError)
```

- Alternatively, use the `WeakRef#weakref_alive?` method to check that a reference is valid before using it. Garbage collection must be disabled during the test and subsequent reference to the object. In a single-threaded program, you could use something like

```
ref = WeakRef.new(some_object)
.. some time later
gc_was_disabled = GC.disable
if ref.weakref_alive?
 # do stuff with 'ref'
end
GC.enable unless gc_was_disabled
```



WEBrick is a pure-Ruby framework for implementing HTTP-based servers. The standard library includes WEBrick services that implement a standard Web server (serving files and directory listings), and servlets supporting CGI, erb, file download, and the mounting of Ruby lambdas.

More examples of WEBrick start on page 234.

- The following code mounts two Ruby procs on a Web server. Requests to the URI <http://localhost:2000/hello> run one proc, and requests to <http://localhost:2000/bye> run the other.

```
#!/usr/bin/ruby
require 'webrick'
include WEBrick

hello_proc = lambda do |req, resp|
 resp['Content-Type'] = "text/html"
 resp.body = %{
 <html><body>
 Hello. You're calling from a #{req['User-Agent']}
 <p>
 I see parameters: #{req.query.keys.join(', ')}
 </body></html>
 }
end

bye_proc = lambda do |req, resp|
 resp['Content-Type'] = "text/html"
 resp.body = %{
 <html><body>
 <h3>Goodbye!</h3>
 </body></html>
 }
end

hello = HTTPServlet::ProcHandler.new(hello_proc)
bye = HTTPServlet::ProcHandler.new(bye_proc)
s = HTTPServer.new(:Port => 2000)
s.mount("/hello", hello)
s.mount("/bye", bye)
trap("INT"){ s.shutdown }
s.start
```

Only if: Windows

The Win32API module allows access to any arbitrary Windows 32 function. Many of these functions take or return a `Pointer` data type—a region of memory corresponding to a C string or structure type.

In Ruby, these pointers are represented using class `String`, which contains a sequence of 8-bit bytes. It is up to you to pack and unpack the bits in the `String`. See the reference section for `unpack` on page 602 and `pack` on page 415 for details.

Parameters 3 and 4 of the `new` call specify the parameter and return types of the method to be called. The type specifiers are `n` and `l` for numbers, `i` for integers, `p` for pointers to data stored in a string, and `v` for the void type (used for export parameters only). These strings are case-insensitive. Method parameters are specified as an array of strings, and the return type is a single string.

The functionality of Win32API is also provided using the `dl/win32` library. As the `DL` library is newer, this may be a sign that the original Win32API may be phased out over time.

See also: `DL` (page 648)

- This example is from the Ruby distribution, in `ext/Win32API`.

```
require 'Win32API'
get_cursor_pos = Win32API.new("user32", "GetCursorPos", ['P'], 'V')
lpPoint = " " * 8 # store two LONGs
get_cursor_pos.Call(lpPoint)
x, y = lpPoint.unpack("LL") # get the actual values
print "x: ", x, "\n"
print "y: ", y, "\n"
ods = Win32API.new("kernel32", "OutputDebugString", ['P'], 'V')
ods.Call("Hello, World\n")
GetDesktopWindow = Win32API.new("user32", "GetDesktopWindow", [], 'L')
GetActiveWindow = Win32API.new("user32", "GetActiveWindow", [], 'L')
SendMessage = Win32API.new("user32", "SendMessage", ['L'] * 4, 'L')
SendMessage.Call(GetDesktopWindow.Call, 274, 0xf140, 0)
```

Only if: Windows

Interface to Windows automation, allowing Ruby code to interact with Windows applications. The Ruby interface to Windows is discussed in more detail in Chapter 20 on page 253.

See also: Win32API (page 734)

- Open Internet Explorer, and ask it to display our home page.

```
ie = WIN32OLE.new('InternetExplorer.Application')
ie.visible = true
ie.navigate("http://www.pragmaticprogrammer.com")
```

- Create a new chart in Microsoft Excel, and then rotate it.

```
require 'win32ole'
-4100 is the value for the Excel constant xl3DColumn.
ChartTypeVal = -4100;
excel = WIN32OLE.new("excel.application")
Create and rotate the chart
excel['Visible'] = TRUE
excel.Workbooks.Add()
excel.Range("a1")['Value'] = 3
excel.Range("a2")['Value'] = 2
excel.Range("a3")['Value'] = 1
excel.Range("a1:a3").Select()
excelchart = excel.Charts.Add()
excelchart['Type'] = ChartTypeVal
30.step(180, 5) do |rot|
 excelchart.rotation = rot
 sleep(0.1)
end
excel.ActiveWorkbook.Close(0)
excel.Quit()
```

XMLRPC allows clients to invoke methods on networked servers using the XML-RPC protocol. Communications take place over HTTP. The server may run in the context of a Web server, in which case ports 80 or 443 (for SSL) will typically be used. The server may also be run stand-alone. The Ruby XML-RPC server implementation supports operation as a CGI script, as a `mod_ruby` script, as a WEBrick handler, and as a stand-alone server. Basic authentication is supported, and clients can communicate with servers via proxies. Servers may throw `FaultException` errors—these generate the corresponding exception on the client (or optionally may be flagged as a status return to the call).

See also: SOAP (page 236), dRuby (page 649), WEBrick (page 733)

- The following simple server accepts a temperature in Celsius and converts it to Fahrenheit. It runs within the context of the WEBrick Web server.

```
require 'webrick'
require 'xmlrpc/server'
xml_servlet = XMLRPC::WEBrickServlet.new
xml_servlet.add_handler("convert_celcius") do |celcius|
 celcius*1.8 + 32
end
xml_servlet.add_multicall # Add support for multicall
server = WEBrick::HTTPServer.new(:Port => 2000)
server.mount("/RPC2", xml_servlet)
trap("INT"){ server.shutdown }
server.start
```

- This client makes calls to the temperature conversion server. Note that in the output we show both the server's logging and the client program's output.

```
require 'xmlrpc/client'
server = XMLRPC::Client.new("localhost", "/RPC2", 2000)
puts server.call("convert_celcius", 0)
puts server.call("convert_celcius", 100)
puts server.multicall(['convert_celcius', -10],
 ['convert_celcius', 200])
```

*produces:*

```
[2004-04-16 06:57:02] INFO WEBrick 1.3.1
[2004-04-16 06:57:02] INFO WEBrick::HTTPServer#start: pid=11956 port=2000
localhost - - [16/Apr/2004:06:57:13 PDT] "POST /RPC2 HTTP/1.1" 200 124 - -> /RPC2
32.0
localhost - - [16/Apr/2004:06:57:13 PDT] "POST /RPC2 HTTP/1.1" 200 125 - -> /RPC2
212.0
localhost - - [16/Apr/2004:06:57:14 PDT] "POST /RPC2 HTTP/1.1" 200 290 - -> /RPC2
14.0
392.0
```

The YAML library (also described in the tutorial starting on page 397) serializes and deserializes Ruby object trees to and from an external, readable, plain-text format. YAML can be used as a portable object marshaling scheme, allowing objects to be passed in plain text between separate Ruby processes. In some cases, objects may also be exchanged between Ruby programs and programs in other languages that also have YAML support.

- YAML can be used to store an object tree in a flat file.

```
require 'yaml'
tree = { :name => 'ruby',
 :uses => ['scripting', 'web', 'testing', 'etc']
 }
File.open("tree.yaml", "w") {|f| YAML.dump(tree, f)}
```

- Once stored, it can be read by another program.

```
require 'yaml'
tree = YAML.load(File.open("tree.yaml"))
tree[:uses][1] → "web"
```

- The YAML format is also a convenient way to store configuration information for programs. Because it is readable, it can be maintained by hand using a normal editor, and then read as objects by programs. For example, a configuration file may contain

```

username: dave
prefs:
 background: dark
 foreground: cyan
 timeout: 30
```

We can use this in a program:

```
require 'yaml'

config = YAML.load(File.open("code/config.yaml"))
config["username"] → "dave"
config["prefs"]["timeout"] * 10 → 300
```

Library **Zlib**

## Read and Write Compressed Files

Only if: zlib library  
available

The Zlib module is home to a number of classes that can read and write zip- and gzip-format compressed files. They also calculate zip checksums.

- Compress `/etc/passwd` as a gzip file, and then read the result back.

```
require 'zlib'
These methods can take a filename
Zlib::GzipWriter.open("passwd.gz") do |gz|
 gz.write(File.read("/etc/passwd"))
end
system("ls -l /etc/passwd passwd.gz")
or a stream
File.open("passwd.gz") do |f|
 gzip = Zlib::GzipReader.new(f)
 data = gzip.read.split(/\n/)
 puts data[15,3]
end
```

*produces:*

```
-rw-r--r-- 1 root wheel 1374 12 Sep 2003 /etc/passwd
-rw-r--r-- 1 dave dave 635 26 Aug 22:39 passwd.gz
```

```
daemon:::1:1:System Services:/var/root:/usr/bin/false
smmsp:::25:25:Sendmail User:/private/etc/mail:/usr/bin/false
lp:::26:26:Printing Services:/var/spool/cups:/usr/bin/false
```

- Compress data sent between two processes.

```
require 'zlib'
rd, wr = IO.pipe
if fork
 rd.close
 zipper = Zlib::Deflate.new
 zipper << "This is a string "
 data = zipper.deflate("to compress", Zlib::FINISH)
 wr.write(data)
 wr.close
 Process.wait
else
 wr.close
 unzipper = Zlib::Inflate.new
 unzipper << rd.read
 puts "We got: #{unzipper.inflate(nil)}"
end
```

*produces:*

```
We got: This is a string to compress
```

---

**Part V**

**Appendixes**

---

# Socket Library

---

Because the socket and network libraries are such important parts of integrating Ruby applications with the 'net, we've decided to document them in more detail than the other standard libraries.

The hierarchy of socket classes is shown in the diagram below.

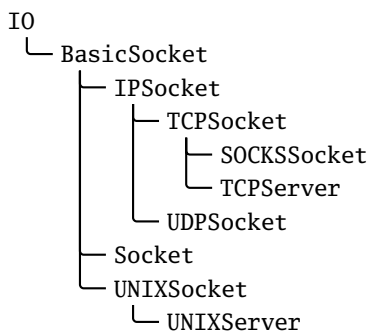



**Class** **BasicSocket** < IO

BasicSocket is an abstract base class for all other socket classes.

This class and its subclasses often manipulate addresses using something called a `struct sockaddr`, which is effectively an opaque binary string.<sup>1</sup>

**Class methods**

---

**do\_not\_reverse\_lookup** `BasicSocket.do_not_reverse_lookup` → true or false

Returns the value of the global reverse lookup flag.

---

**do\_not\_reverse\_lookup=** `BasicSocket.do_not_reverse_lookup=` true or false

Sets the global reverse lookup flag. If set to true, queries on remote addresses will return the numeric address but not the host name.

---

**for\_fd** `BasicSocket.for_fd(fd)` → *sock*

Wraps an already open file descriptor into a socket object.

---

**lookup\_order=** `BasicSocket.lookup_order=` *int*

Sets the global address lookup order.

**Instance methods**

---

**close\_read** `sock.close_read` → nil

Closes the readable connection on this socket.

---

**close\_write** `sock.close_write` → nil

Closes the writable connection on this socket.

---

**getpeername** `sock.getpeername` → *string*

Returns the `struct sockaddr` structure associated with the other end of this socket connection.

---

**getsockname** `sock.getsockname` → *string*

Returns the `struct sockaddr` structure associated with *sock*.

---

**getsockopt** `sock.getsockopt(level, optname)` → *string*

Returns the value of the specified option.

---

1. In reality, it maps onto the underlying C-language `struct sockaddr` set of structures, documented in the man pages and in the books by Stevens.

---

**recv** *sock.recv( len, ⟨ , flags ⟩ ) → string*

---

Receives up to *len* bytes from *sock*.

---

**send** *sock.send( string, flags, ⟨ , to ⟩ ) → int*

---

Sends *string* over *sock*. If specified, *to* is a struct `sockaddr` specifying the recipient address. *flags* are the sum of one or more of the MSG\_ options (listed on the following page). Returns the number of characters sent.

---

**setsockopt** *sock.setsockopt( level, optname, optval ) → 0*

---

Sets a socket option. *level* is one of the socket-level options (listed on the next page). *optname* and *optval* are protocol specific—see your system documentation for details.

---

**shutdown** *sock.shutdown( how=2 ) → 0*

---

Shuts down the receive (*how* == 0), sender (*how* == 1), or both (*how* == 2), parts of this socket.

**Class** **Socket** < BasicSocket

Class `Socket` provides access to the underlying operating system socket implementation. It can be used to provide more operating system–specific functionality than the protocol-specific socket classes but at the expense of greater complexity. In particular, the class handles addresses using `struct sockaddr` structures packed into Ruby strings, which can be a joy to manipulate.

**Class constants**

Class `Socket` defines constants for use throughout the socket library. Individual constants are available only on architectures that support the related facility.

**Types:**

`SOCK_DGRAM`, `SOCK_PACKET`, `SOCK_RAW`, `SOCK_RDM`, `SOCK_SEQPACKET`, `SOCK_STREAM`

**Protocol families:**

`PF_APPLETALK`, `PF_AX25`, `PF_INET6`, `PF_INET`, `PF_IPX`, `PF_UNIX`, `PF_UNSPEC`

**Address families:**

`AF_APPLETALK`, `AF_AX25`, `AF_INET6`, `AF_INET`, `AF_IPX`, `AF_UNIX`, `AF_UNSPEC`

**Lookup-order options:**

`LOOKUP_INET6`, `LOOKUP_INET`, `LOOKUP_UNSPEC`

**Send/receive options:**

`MSG_DONTROUTE`, `MSG_OOB`, `MSG_PEEK`

**Socket-level options:**

`SOL_ATALK`, `SOL_AX25`, `SOL_IPX`, `SOL_IP`, `SOL_SOCKET`, `SOL_TCP`, `SOL_UDP`

**Socket options:**

`SO_BROADCAST`, `SO_DEBUG`, `SO_DONTROUTE`, `SO_ERROR`, `SO_KEEPALIVE`, `SO_LINGER`,  
`SO_NO_CHECK`, `SO_OOBINLINE`, `SO_PRIORITY`, `SO_RCVBUF`, `SO_REUSEADDR`, `SO_SNDBUF`,  
`SO_TYPE`

**QOS options:**

`SOPRI_BACKGROUND`, `SOPRI_INTERACTIVE`, `SOPRI_NORMAL`

**Multicast options:**

`IP_ADD_MEMBERSHIP`, `IP_DEFAULT_MULTICAST_LOOP`, `IP_DEFAULT_MULTICAST_TTL`,  
`IP_MAX_MEMBERSHIPS`, `IP_MULTICAST_IF`, `IP_MULTICAST_LOOP`, `IP_MULTICAST_TTL`

**TCP options:**

`TCP_MAXSEG`, `TCP_NODELAY`

**getaddrinfo error codes:**

EAI\_ADDRFAMILY, EAI\_AGAIN, EAI\_BADFLAGS, EAI\_BADHINTS, EAI\_FAIL, EAI\_FAMILY,  
 EAI\_MAX, EAI\_MEMORY, EAI\_NODATA, EAI\_NONAME, EAI\_PROTOCOL, EAI\_SERVICE,  
 EAI\_SOCKTYPE, EAI\_SYSTEM

**ai\_flags values:**

AI\_ALL, AI\_CANONNAME, AI\_MASK, AI\_NUMERICHOST, AI\_PASSIVE, AI\_V4MAPPED\_CFG

## Class methods

---

**getaddrinfo** Socket.getaddrinfo(*hostname*, *port*,  
 <*family* <, *socktype* <, *protocol* <, *flags*>>>) → array

---

Returns an array of arrays describing the given host and port (optionally qualified as shown). Each subarray contains the address family, port number, host name, host IP address, protocol family, socket type, and protocol.

```
for line in Socket.getaddrinfo('www.microsoft.com', 'http')
 puts line.join(", ")
end
```

*produces:*

```
AF_INET, 80, 207.46.134.221, 207.46.134.221, 2, 2, 17
AF_INET, 80, 207.46.134.221, 207.46.134.221, 2, 1, 6
AF_INET, 80, origin2.microsoft.com, 207.46.144.188, 2, 2, 17
AF_INET, 80, origin2.microsoft.com, 207.46.144.188, 2, 1, 6
AF_INET, 80, microsoft.com, 207.46.230.219, 2, 1, 6
AF_INET, 80, microsoft.net, 207.46.130.14, 2, 1, 6
```

---

**gethostbyaddr** Socket.gethostbyaddr(*addr*, *type*=AF\_INET) → array

---

Returns the host name, address family, and sockaddr component for the given address.

```
a = Socket.gethostbyname("161.58.146.238")
res = Socket.gethostbyaddr(a[3], a[2])
res.join(', ') → "www.pragmaticprogrammer.com, , 2, \241:\222\356"
```

---

**gethostbyname** Socket.gethostbyname(*hostname*) → array

---

Returns a four-element array containing the canonical host name, a subarray of host aliases, the address family, and the address portion of the sockaddr structure.

```
a = Socket.gethostbyname("63.68.129.130")
a.join(', ') → "63.68.129.130, , 2, ?D\201\202"
```

---

**gethostname** *sock.gethostname* → string

---

Returns the name of the current host.

```
Socket.gethostname → "wireless_2.local.thomases.com"
```

---

**getnameinfo** Socket.getnameinfo(*addr* ⟨, *flags*⟩) → array

---

Looks up the given address, which may be either a string containing a `sockaddr` or a three- or four-element array. If *addr* is an array, it should contain the string address family, the port (or `nil`), and the host name or IP address. If a fourth element is present and not `nil`, it will be used as the host name. Returns a canonical host name (or address) and port number as an array.

```
Socket.getnameinfo(["AF_INET", '23', 'www.ruby-lang.org'])
```

---

**getservbyname** Socket.getservbyname(*service*, *proto*='tcp') → int

---

Returns the port corresponding to the given service and protocol.

```
Socket.getservbyname("telnet") → 23
```

---

**new** Socket.new(*domain*, *type*, *protocol*) → sock

---

Creates a socket using the given parameters.

---

**open** Socket.open(*domain*, *type*, *protocol*) → sock

---

Synonym for `Socket.new`.

---

**pack\_sockaddr\_in** Socket.pack\_sockaddr\_in(*port*, *host*) → str\_address

---

1.8 Given a port and a host, return the (system dependent) `sockaddr` structure as a string of bytes.

```
require 'socket'
addr = Socket.pack_sockaddr_in(80, "pragprog.com")
Pragprog.com is 216.87.136.211
addr.unpack("CCnC4") → [16, 2, 80, 216, 87, 136, 211]
```

---

**pack\_sockaddr\_un** Socket.pack\_sockaddr\_un(*path*) → str\_address

---

1.8 Given a path to a Unix socket, return the (system dependent) `sock_addr_un` structure as a string of bytes. Only available on boxes supporting the Unix address family.

```
require 'socket'
addr = Socket.pack_sockaddr_un("/tmp/sample")
addr[0,20] → "\000\001/tmp/sample\000\000\000\000\000\000"
```

---

**pair** Socket.pair(*domain*, *type*, *protocol*) → array

---

Returns an array containing a pair of connected, anonymous `Socket` objects with the given domain, type, and protocol.

---

**socketpair** Socket.socketpair(*domain*, *type*, *protocol*) → array

---

Synonym for `Socket.pair`.

---

**unpack\_sockaddr\_in** `Socket.pack_sockaddr_in(string_address) → [ port, host ]`

---

1.8 Given a string containing a binary `addrinfo` structure, return the port and host.

```
require 'socket'
addr = Socket.pack_sockaddr_in(80, "pragprog.com")
Socket.unpack_sockaddr_in(addr) → [80, "216.87.136.211"]
```

---

**unpack\_sockaddr\_un** `Socket.pack_sockaddr_in(string_address) → [ port, host ]`

---

1.8 Given a string containing a binary `sock_addr_un` structure, returns the path to the Unix socket. Only available on boxes supporting the Unix address family.

```
require 'socket'
addr = Socket.pack_sockaddr_in(80, "pragprog.com")
Socket.unpack_sockaddr_in(addr) → [80, "216.87.136.211"]
```

## Instance methods

---

**accept** `sock.accept → [ socket, address ]`

---

Accepts an incoming connection returning an array containing a new `Socket` object and a string holding the struct `sockaddr` information about the caller.

---

**bind** `sock.bind( sockaddr ) → 0`

---

Binds to the given struct `sockaddr`, contained in a string.

---

**connect** `sock.connect( sockaddr ) → 0`

---

Connects to the given struct `sockaddr`, contained in a string.

---

**listen** `sock.listen( int ) → 0`

---

Listens for connections, using the specified `int` as the backlog.

---

**recvfrom** `sock.recvfrom( len < , flags > ) → [ data, sender ]`

---

Receives up to `len` bytes from `sock`. `flags` is zero or more of the `MSG_` options. The first element of the result is the data received. The second element contains protocol-specific information on the sender.

---

**sysaccept** `sock.sysaccept → [ socket_fd, address ]`

---

1.8 Accepts an incoming connection. Returns an array containing the (integer) file descriptor of the incoming connection and a string holding the struct `sockaddr` information about the caller.

**Class** **IPSocket** < BasicSocket

Class IPsocket is a base class for sockets using IP as their transport. TCPSocket and UDPSocket are based on this class.

**Class methods**

---

**getaddress** IPSocket.getaddress(*hostname*) → *string*

---

Returns the dotted-quad IP address of *hostname*.

```
a = IPsocket.getaddress('www.ruby-lang.org')
a → "210.251.121.210"
```

**Instance methods**

---

**addr** *sock.addr* → *array*

---

Returns the domain, port, name, and IP address of *sock* as a four-element array. The name will be returned as an address if the `do_not_reverse_lookup` flag is true.

```
u = UDPSocket.new
u.bind('localhost', 8765)
u.addr → ["AF_INET", 8765, "localhost", "127.0.0.1"]
BasicSocket.do_not_reverse_lookup = true
u.addr → ["AF_INET", 8765, "127.0.0.1", "127.0.0.1"]
```

---

**peeraddr** *sock.peeraddr* → *array*

---

Returns the domain, port, name, and IP address of the peer.

---

**recvfrom** *sock.recvfrom*(*len* < , *flags* >) → [*data*, *sender*]

---

1.8

Receives up to *len* bytes on the connection. *flags* is zero or more of the MSG\_ options (listed on page 743). Returns a two-element array. The first element is the received data, and the second is an array containing information about the peer. On systems such as my Mac OS X box where the native `recvfrom()` method does not return peer information for TCP connections, the second element of the array is `nil`.

```
require 'socket'
t = TCPSocket.new('localhost', 'ftp')
data = t.recvfrom(40)
data → ["220 localhost FTP server (lukemftpd 1.1)", nil]
t.close → nil
```

**Class** **TCPSocket** < IPsocket

```
t = TCPSocket.new('localhost', 'ftp')
t.gets → "220 localhost FTP server (lukemftpd 1.1) ready.\r\n"
t.close → nil
```

**Class methods**

---

**gethostbyname** TCPSocket.gethostbyname(*hostname*) → *array*

---

Looks up *hostname* and returns its canonical name, an array containing any aliases, the address type (AF\_INET), and the dotted-quad IP address.

```
a = TCPSocket.gethostbyname('ns.pragprog.com')
a → ["pragprog.com", [], 2, "216.87.136.211"]
```

---

**new** TCPSocket.new(*hostname*, *port*) → *sock*

---

Opens a TCP connection to *hostname* on the *port*.

---

**open** TCPSocket.open(*hostname*, *port*) → *sock*

---

Synonym for TCPSocket.new.



**Class** **SOCKSSocket** < TCPSocket

Class SOCKSSocket supports connections based on the SOCKS protocol.

**Class methods**

---

**new** SOCKSSocket.new( *hostname*, *port* ) → *sock*

Opens a SOCKS connection to *port* on *hostname*.

---

**open** SOCKSSocket.open( *hostname*, *port* ) → *sock*

Synonym for SOCKSSocket .new.

**Instance methods**

---

**close** *sock*.close → nil

Closes this SOCKS connection.

**Class** **TCPServer** < TCPSocket

A TCPServer accepts incoming TCP connections. Here is a Web server that listens on a given port and returns the time.

```
require 'socket'
port = (ARGV[0] || 80).to_i
server = TCPServer.new('localhost', port)
while (session = server.accept)
 puts "Request: #{session.gets}"
 session.print "HTTP/1.1 200/OK\r\nContent-type: text/html\r\n\r\n"
 session.print "<html><body><h1>#{Time.now}</h1></body></html>\r\n"
 session.close
end
```

**Class methods**

---

**new** TCPServer.new( *hostname*, *port* ) → *sock*

---

Creates a new socket on the given interface (identified by *hostname* and *port*). If *hostname* is omitted, the server will listen on all interfaces on the current host (equivalent to an address of 0.0.0.0).

---

**open** TCPServer.open( *hostname*, *port* ) → *sock*

---

Synonym for TCPServer.new.

**Instance methods**

---

**accept** *sock*.accept → *tcp\_socket*

---

Waits for a connection on *sock*, and returns a new *tcp\_socket* connected to the caller. See the example on the current page.

**Class** **UDPSocket** < IPSocket

UDP sockets send and receive datagrams. To receive data, a socket must be bound to a particular port. You have two choices when sending data: you can connect to a remote UDP socket and thereafter send datagrams to that port, or you can specify a host and port for use with every packet you send. This example is a UDP server that prints the message it receives. It is called by both connectionless and connection-based clients.

```
require 'socket'
$port = 4321
server_thread = Thread.start do # run server in a thread
 server = UDPSocket.open
 server.bind(nil, $port)
 2.times { p server.recvfrom(64) }
end
Ad-hoc client
UDPSocket.open.send("ad hoc", 0, 'localhost', $port)
Connection based client
sock = UDPSocket.open
sock.connect('localhost', $port)
sock.send("connection-based", 0)
server_thread.join

produces:

["ad hoc", ["AF_INET", 52097, "localhost", "127.0.0.1"]]
["connection-based", ["AF_INET", 52098, "localhost", "127.0.0.1"]]
```

**Class methods**

---

**new** UDPSocket.new(*family* = AF\_INET) → *sock*

---

Creates a UDP endpoint, optionally specifying an address family.

---

**open** UDPSocket.open(*family* = AF\_INET) → *sock*

---

Synonym for UDPSocket.new.

**Instance methods**

---

**bind** *sock*.bind(*hostname*, *port*) → 0

---

Associates the local end of the UDP connection with a given *hostname* and *port*. Must be used by servers to establish an accessible endpoint.

---

**connect** *sock*.connect(*hostname*, *port*) → 0

---

Creates a connection to the given *hostname* and *port*. Subsequent UDPSocket#send requests that don't override the recipient will use this connection. Multiple connect requests may be issued on *sock*: the most recent will be used by send.

---

**recvfrom** *sock.recvfrom( len < , flags > ) → [ data, sender ]*

---

Receives up to *len* bytes from *sock*. *flags* is zero or more of the MSG\_ options (listed on page 743). The result is a two-element array containing the received data and information on the sender. See the example on the page before.

---

**send** *sock.send( string, flags ) → int*  
*sock.send( string, flags, hostname, port ) → int*

---

The two-parameter form sends *string* on an existing connection. The four-parameter form sends *string* to *port* on *hostname*.

**Class** UNIXSocket < BasicSocket

Class UNIXSocket supports interprocess communications using the Unix domain protocol. Although the underlying protocol supports both datagram and stream connections, the Ruby library provides only a stream-based connection.

```
require 'socket'
SOCKET = "/tmp/sample"
server_thread = Thread.start do # run server in a thread
 sock = UNIXServer.open(SOCKET)
 s1 = sock.accept
 p s1.recvfrom(124)
end
client = UNIXSocket.open(SOCKET)
client.send("hello", 0)
client.close
server_thread.join
```

*produces:*

```
["hello", ["AF_UNIX", "q\240"]]
```

**Class methods**

---

**new** UNIXSocket.new(*path*) → *sock*

---

Opens a new domain socket on *path*, which must be a pathname.

---

**open** UNIXSocket.open(*path*) → *sock*

---

Synonym for UNIXSocket.new.

**Instance methods**

---

**addr** *sock*.addr → *array*

---

Returns the address family and path of this socket.

---

**path** *sock*.path → *string*

---

Returns the path of this domain socket.

---

**peeraddr** *sock*.peeraddr → *array*

---

Returns the address family and path of the server end of the connection.

---

**recvfrom** *sock*.recvfrom(*len* ⟨ *, flags* ⟩) → *array*

---

Receives up to *len* bytes from *sock*. *flags* is zero or more of the MSG\_ options (listed on page 743). The first element of the returned array is the received data, and the second contains (minimal) information on the sender.

**Class** **UNIXServer** < UNIXSocket

Class UNIXServer provides a simple Unix domain socket server. See UNIXSocket for example code.

**Class methods**

---

**new** UNIXServer.new(*path*) → *sock*

Creates a server on the given *path*. The corresponding file must not exist at the time of the call.

---

**open** UNIXServer.open(*path*) → *sock*

Synonym for UNIXServer.new.

**Instance methods**

---

**accept** *sock*.accept → *unix\_socket*

Waits for a connection on the server socket and returns a new socket object for that connection. See the example for UNIXSocket on the page before.

# MKMF Reference

The `mkmf` library is used by Ruby extension modules to help create Makefiles. Chapter 21, which starts on page 261, describes how these extensions are created and built. This appendix describes the details of the `mkmf` library.

Module	<b>mkmf</b>	require	<b>"mkmf"</b>
--------	-------------	---------	---------------

When writing an extension, you create a program named `extconf.rb`, which may be as simple as

```
require 'mkmf'
create_makefile("Test")
```

When run, this script will produce a Makefile suited to the target platform. It also produces a log file, `mkmf.log`, which may help in diagnosing build problems.

`mkmf` contains several methods you can use to find libraries and include files and to set compiler flags.

`mkmf` takes configuration information from a variety of sources

- The configuration used when Ruby was built.
- The environment variable `CONFIGURE_ARGS`, a list of *key=value* pairs.
- Command line arguments of the form *key=value* or `--key=value`.

You can examine the configuration by dumping the variable `$configure_args`.

```
% export CONFIGURE_ARGS="ruby=ruby18 --enable-extras"
% ruby -rmkmf -rpp -e 'pp $configure_args' -- --with-cflags=-O3
{"--topsrcdir"=>".",
 "--topdir"=>"/Users/dave/Work/rubybook/tmp",
 "--enable-extras"=>true,
 "--with-cflags"=>"-O3",
 "--ruby"=>"ruby18"}
```

The following configuration options are recognized.

**CFLAGS**

Flags passed to the C compiler (overridden by `--with-cflags`).

**CPPFLAGS**

Flags passed to the C++ compiler (overridden by `--with-cppflags`).

**curdir**

Sets the global `$curdir`, which may be used inside the `extconf.rb` script. Otherwise has no effect.

**disable-xxx**

Disables extension-specific option `xxx`.

**enable-xxx**

Enables extension-specific option `xxx`.

**LDFLAGS**

Flags passed to the linker (overridden by `--with-ldflags`).

**ruby**

Sets the name and/or path of the Ruby interpreter used in the Makefile.

**srcdir**

Sets the path to the source directory in the Makefile.

**with-cflags**

Flags passed to the C compiler. Overrides the `CFLAGS` environment variable.

**with-cppflags**

Flags passed to the C++ compiler. Overrides the `CPPFLAGS` environment variable.

**with-ldflags**

Flags passed to the linker compiler. Overrides the `LDFLAGS` environment variable.

**with-make-prog**

Sets the name of the make program. If running on Windows, the choice of make program affects the syntax of the generated Makefile (`nmake` vs. Borland `make`).

**with-xxx-{dir|include|lib}**

Controls where the `dir_config` method looks.



## Instance methods

---

**create\_makefile** create\_makefile(*target*, *srcprefix*=nil)

---

Creates a Makefile for an extension named *target*. The *srcprefix* can override the default source directory. If this method is not called, no Makefile is created.

---

**dir\_config** dir\_config(*name*)

---

Looks for directory configuration options for *name* given as arguments to this program or to the original build of Ruby. These arguments may be one of

```
--with-name-dir=directory
--with-name-include=directory
--with-name-lib=directory
```

The given directories will be added to the appropriate search paths (include or link) in the Makefile.

---

**enable\_config** enable\_config(*name*, *default*=nil) → true or false or *default*

---

Tests for the presence of an `--enable-name` or `--disable-name` option. Returns true if the enable option is given, false if the disable option is given, and the default value otherwise.

---

**find\_library** find\_library(*name*, *function*, <*path*>+) → true or false

---

Same as `have_library`, but will also search in the given directory paths.

---

**have\_func** have\_func(*function*) → true or false

---

If the named function exists in the standard compile environment, adds the directive `-DHAVE_FUNCTION` to the compile command in the Makefile and returns true.

---

**have\_header** have\_header(*header*) → true or false

---

If the given header file can be found in the standard search path, adds the directive `-DHAVE_HEADER` to the compile command in the Makefile and returns true.

---

**have\_library** have\_library(*library*, *function*) → true or false

---

If the given function exists in the named library, which must exist in the standard search path or in a directory added with `dir_config`, adds the library to the link command in the Makefile and returns true.

## Appendix C

# Support

---

One of the major features of open source projects is the technical support. Articles in the mass media often criticize open source efforts for not having the same tech support that a commercial product has. And boy is that a good thing! Instead of dialing up some overworked and understaffed help desk and being treated to Music On Hold for an hour or so *without* ever getting the answer you need, we have a better solution: the Ruby community. The author of Ruby, the authors of this book, and many other Ruby users are willing and able to lend you a hand, should you need it.

The syntax of Ruby remains fairly stable, but as with all evolving software, new features are added every now and again. As a result, both printed books and the online documentation can fall behind. All software has bugs, and Ruby is no exception. There aren't many, but they do crop up.

If you experience a problem with Ruby, feel free to ask in the mailing lists or on the newsgroup (more on those in just a minute). Generally you'll get timely answers from Matz himself, the author of the language, from other gurus, and from those who've solved problems similar to your own.

You may be able to find similar questions in the mailing lists or on the newsgroup, and it is good "netiquette" to read through recent postings before asking. If you can't find the answer you need, ask, and a correct answer will usually show up with remarkable speed and precision.

## Web Sites

Because the Web changes too fast, we've kept this list short. Visit one of the sites here, and you'll find a wealth of links to other online Ruby resources.

The official Ruby home page is <http://www.ruby-lang.org>.

You'll find a number of Ruby libraries and applications on RubyForge on the Web at <http://www.rubyforge.org>.

RubyForge hosts open-source projects for Ruby developers. Each project has a CVS repository, space to store releases, bug and feature request tracking, a WikiWiki web and mailing lists. Anyone can apply to have a project hosted on this site. RubyForge is also the repository for downloadable RubyGems.

The Ruby Production Archive (RPA) at <http://www.rubyarchive.org> hosts a number of prepackaged Ruby libraries and applications. The site is intended to offer a service similar to that provided by Debian or FreeBSD to their respective communities but for Ruby users. The site had only just become available as this book went to press, and we have no direct experience using it.

Rubygarden hosts both a portal (<http://www.rubygarden.org>) and a WikiWiki site (<http://www.rubygarden.org/ruby>), both full of useful Ruby information.

<http://www.ruby-doc.org> is a portal to various sources of Ruby documentation.

While you're surfing, drop in on <http://www.pragmaticprogrammer.com> and see what we're up to.

## Download Sites

You can download the latest version of Ruby from

<http://www.ruby-lang.org/en/>

A precompiled Windows distribution is available from

<http://rubyinstaller.rubyforge.org/>

This project is also planning to release a Mac OS X One-Click Installer, but this was not ready at the time this book went to press.

## Usenet Newsgroup

Ruby has its own newsgroup, `comp.lang.ruby`. Traffic on this group is archived and mirrored to the `ruby-talk` mailing list.

## Mailing Lists

You'll find many mailing lists talking about Ruby. The first three below are in English, and the remainder are mostly Japanese, but with some English language posts.

---

<code>ruby-talk@ruby-lang.org</code>	English language discussion of Ruby (mirrored to <code>comp.lang.ruby</code> )
<code>ruby-doc@ruby-lang.org</code>	Documentation standards and tools
<code>ruby-cvs@ruby-lang.org</code>	Notifications of CVS commits to Ruby source
<code>ruby-core@ruby-lang.org</code>	Mixed English/Japanese discussion of core implementation topics
<code>ruby-list@ruby-lang.org</code>	Japanese language discussion of Ruby
<code>ruby-dev@ruby-lang.org</code>	List for Ruby developers
<code>ruby-ext@ruby-lang.org</code>	List for people writing extensions for or with Ruby
<code>ruby-math@ruby-lang.org</code>	Ruby in mathematics

---

See the “Mailing Lists” topic under <http://www.ruby-lang.org/> for details on joining a mailing list.

The mailing lists are archived and can be searched using

<http://blade.nagaokaut.ac.jp/ruby/ruby-talk/index.shtml>,

or using

<http://www.ruby-talk.org>.

## Appendix D

# Bibliography

---

- [FJN02] Robert Feldt, Lyle Johnson, and Micheal Neuman. *The Ruby Developer's Guide*. Syngress Publishing, Inc, Rockland, MA, 2002.
- [Fri02] Jeffrey E. F. Friedl. *Mastering Regular Expressions: Powerful Techniques for Perl and Other Tools*. O'Reilly & Associates, Inc., Sebastopol, CA, second edition, 2002.
- [Ful01] Hal Fulton. *The Ruby Way*. Sams Publishing, 2001.
- [GHJV95] Erich Gamma, Richard Helm, Ralph Johnson, and John Vlissides. *Design Patterns: Elements of Reusable Object-Oriented Software*. Addison-Wesley, Reading, MA, 1995.
- [Lid98] Stephen Lidie. *Perl/Tk Pocket Reference*. O'Reilly & Associates, Inc., Sebastopol, CA, 1998.
- [Mey97] Bertrand Meyer. *Object-Oriented Software Construction*. Prentice Hall, Englewood Cliffs, NJ, second edition, 1997.
- [Wal99] Nancy Walsh. *Learning Perl/Tk: Graphical User Interfaces with Perl*. O'Reilly & Associates, Inc., Sebastopol, CA, 1999.

# Index

Order

Every built-in and library method described in this book is indexed at least twice, once under the method's name and again under the name of the class or module that contains it. These entries have the method and class/module names in typewriter font and have the word `method`, `class`, or `module` appended. If you want to know what methods class `String` contains, you can look up “`String` class” in the index. If instead you want to know which classes and modules support a method called `index`, look under “`index` method.” A bold page number for these method listings shows the reference section entry.

When a class or method name corresponds with a broader concept (such as `String`), we've indexed the class separately from the concept.

Symbols are sorted using ASCII collation. The table on the right may help those who haven't yet memorized the positions of the punctuation characters (shame on you all).

## Symbols

! (logical not) 88, 326  
!= (not equal) 89  
!~ (does not match) 65, 89  
# (comment) 302  
#! (shebang) 6  
#{...}  
    substitute in pattern 66, 311  
    substitute in string 57, 306  
\$(global variable prefix) 313  
\$(in pattern) 66, 309  
\$ variables  
  \$! 102, 319, 345, 347  
  \$" 117, 320  
  \$\$ 320  
  & 65, 319, 516  
  \*\$ 320, 502  
  +\$ 319  
  \$, 319, 415, 505  
  \$-0 319  
  \$-F 320  
  \$-I 321

\$-K 321  
\$-a 320  
\$-d 321  
\$-i 321  
\$-l 321  
\$-p 321  
\$-v 321  
\$-w 321  
\$. 319, 489  
\$/ 168, 169, 319, 589  
\$: 117, 152, 168, 173, 290, 320  
\$; 168, 319  
\$< 320  
\$= 309, 319  
\$> 320  
\$? 83, 140, 142, 320, 323, 495, 510, 566, 570  
\$@ 319  
\$\ 169, 319, 490, 505  
\$\_ 22, 89, 95, 168, 320, 327, 489, 502  
\$` 65, 319, 517

\$~ 65, 73, 319, 516, 579–581  
\$1 to \$9 319  
\$1...\$9 65, 70, 311  
\$0 170, 320, 322  
\$configure\_args 755  
\$DEBUG 168, 321, 612, 616  
\$deferr 320  
\$defout 320  
\$expect\_verbose 655  
\$F 168, 321  
\$FILENAME 321  
\$KCODE 309, 638, 668  
\$LOAD\_PATH 152, 168, 175, 209–211, 213, 216, 321  
\$SAFE 169, 299, 321, 380, 554, 652  
\$stderr 320  
\$stdin 320  
\$stdout 320  
\$' 65, 319, 517  
\$VERBOSE 168, 169, 321, 513  
*English names* 318, 650

!  
"  
#  
\$  
%  
&  
'  
(  
)  
\*  
+  
,  
-  
.  
/  
:  
;  
<  
=  
>  
?  
@  
[  
\  
]  
^  
\_  
\  
{  
|  
}

- % method
  - class Bignum 420
  - class Fixnum 463
  - class Float 466
  - class String 585
- %W{...} (array of words) 307
- %q{...}, %Q{...} (string literal) 58, 305
- %r{...} (regexp) 65, 309
- %w{...} (array of words) 14, 307
- %x{...} (command expansion) 83, 323, 495
- %{...} (string literal) 58, 305
- & (block parameter to method) 53, 76, 334
- & method
  - class Array 407
  - class Bignum 420
  - class FalseClass 443
  - class Fixnum 463
  - class NilClass 540
  - class Process::Status 570
  - class TrueClass 629
- && (logical and) 88, 326
- (...) (in pattern) 69, 311
- (?... ) (regexp extensions) 311
- \* (array argument) 332
- \* (in pattern) 68, 310
- \* method
  - class Array 407
  - class Bignum 420
  - class Fixnum 463
  - class Float 466
  - class String 586
- \*\* method
  - class Bignum 420
  - class Fixnum 463
  - class Float 466
- + (in pattern) 68, 310
- + method
  - class Array 407
  - class Bignum 420
  - class Fixnum 463
  - class Float 466
  - class String 586
  - class Time 623
- +@ method
  - class Numeric 541
- method
  - class Array 407
  - class Bignum 420
  - class Fixnum 463
- class Float 466
- class Time 623
- @ method
  - class Bignum 420
  - class Fixnum 463
  - class Float 466
  - class Numeric 541
- . (in pattern) 310
- .. and ... (range) 62, 327
- / method
  - class Bignum 420
  - class Fixnum 463
  - class Float 466
- /.../ (regexp) 65, 309
- : (symbol creation) 308, 323
- : (then replacement) 91, 93
- :: (scope resolution) 315, 323, 337, 339
- vs. "." 334
- ; (line separator) 302
- < (superclass) 337
- < method
  - module Comparable 426
- <, <=, >, >= method
- class Module 525
- <= method
  - module Comparable 426
- <=> (comparison operator) 63, 89, 426, 433
- <=> method
  - class Array 408
  - class Bignum 420
  - class File::Stat 456
  - class Fixnum 463
  - class Float 466
  - class Module 525
  - class Numeric 541
  - class String 586
  - class Time 623
- <<
  - here document 58, 306
  - singleton object 337, 365
- << method
  - class Array 407
  - class Bignum 420
  - class Fixnum 463
  - class IO 124, 486
  - class String 586
- = (assignment) 84, 323
- == (equals) 89
- == method
  - class Array 408
  - class Bignum 420
  - class Float 467
- class Hash 472
- class Method 522
- class Object 546
- class Process::Status 570
- class Proc 559
- class Range 577
- class Regexp 580
- class String 586
- class Struct 606
- module Comparable 426
- === (case equals) 89, 93, 104, 328
- === method
  - class Module 525
  - class Object 546
  - class Range 577
  - class Regexp 580
  - class String 586
- =>
  - hash creation 43, 307
  - in argument list 80, 333
  - rescue clause 104, 346
- =begin...end 303
- embedded documentation 190
- ~= (match) 65, 89
- ~= method
  - class Object 546
  - class Regexp 580
  - class String 587
- > method
  - module Comparable 426
- >= method
  - module Comparable 426
- >> method
  - class Bignum 420
  - class Fixnum 463
  - class Process::Status 570
- ? (in pattern) 68, 310
- ? (ternary operator) 91
- @ (instance variable prefix) 313
- @@ (class variable prefix) 313
- [ ] method
  - class Array 41, 406, 408
  - class Bignum 421
  - class Dir 428
  - class Fixnum 464
  - class Hash 471, 472
  - class MatchData 516
  - class Method 522
  - class Proc 559
  - class String 587
  - class Struct 606, 607
  - class Thread 614

[ ]= method  
 class Array 41, 409  
 class Hash 472  
 class String 588  
 class Struct 607  
 class Thread 615  
 [...] array literal 14, 307  
 bracket expression 310  
 character class 67  
 \$~ variable 169, 319, 490, 505  
 \ (line continuation) 302  
 \& (in substitution) 71  
 \' (in substitution) 71  
 \+ (in substitution) 71  
 \1...\9  
 in pattern 70, 311  
 in substitution 71  
 \A (in pattern) 309  
 \B (in pattern) 310  
 \D (in pattern) 310  
 \G (in pattern) 310, 311  
 \S (in pattern) 310  
 \W (in pattern) 310  
 \Z (in pattern) 310  
 \' (in substitution) 71  
 \b (in pattern) 310  
 \d (in pattern) 310  
 \n (newline) 12, 306  
 \s (in pattern) 310  
 \w (in pattern) 310  
 \z (in pattern) 310  
 ^ (in pattern) 66, 67, 309  
 ^ method  
 class Bignum 420  
 class FalseClass 443  
 class Fixnum 463  
 class NilClass 540  
 class TrueClass 629  
 \_\_id\_\_ method  
 class Object 546  
 \_\_send\_\_ method  
 class Object 546  
 \_id2ref method  
 module ObjectSpace 557  
 \$` variable 65, 319, 517  
 ` (backquote) method  
 module Kernel 83, 140, 495  
 {...}  
 hash literal 15, 307  
 in pattern 68, 310  
 see also Block  
 --verbose (Ruby option) 514  
 |

in file name 141  
 in pattern 69, 310  
 | method  
 class Array 409  
 class Bignum 420  
 class FalseClass 443  
 class Fixnum 463  
 class NilClass 540  
 class TrueClass 629  
 || (logical or) 88, 326  
 \$~ variable 65, 73, 319, 516,  
 579–581  
 ~ method  
 class Bignum 420  
 class Fixnum 463  
 class Regexp 580  
 class String 588  
 -0[octal] (Ruby option) 168

## A

-a (Ruby option) 168, 320, 321  
 \$-a variable 320  
 Abbrev module 634, 702  
 Abbreviations, calculating 634  
 Abort *see* Exception  
 abort method  
 module Kernel 496  
 module Process 562  
 abort\_on\_exception method  
 class Thread 130, 612, 615  
 abort\_on\_exception= method  
 class Thread 612, 615  
 abs method  
 class Bignum 421  
 class Fixnum 464  
 class Float 467  
 class Numeric 541  
 accept method  
 class Socket 746  
 class TCPServer 750  
 class UNIXServer 754  
 Access control 35, 341  
 method 530, 532, 537, 538  
 overriding in subclass 376  
 see also File, permission  
 Accessor method 27, 86  
 acos method  
 module Math 519  
 acosh method  
 module Math 519  
 ActiveX *see* Microsoft  
 Windows, automation  
 Ad hoc testing 143  
 add method  
 class ThreadGroup 619  
 add\_observer method  
 module Observable 685  
 add method  
 class IPSocket 747  
 class UNIXSocket 753  
 AF\_INET class 667  
 Alias 38, 161, 315  
 alias 336  
 alias\_method method  
 class Module 533  
 module Kernel 391  
 alive? method  
 class Thread 615  
 all? method  
 module Enumerable 433  
 all\_symbols method  
 class Symbol 610  
 ALLOC 279  
 ALLOC\_N 279  
 ALLOCA\_N 280  
 allocate method  
 class Class 425  
 Allocation 273  
 Amrita  
 templates 228  
 Ancestor 25  
 ancestors method  
 class Module 365, 386, 526  
 and (logical and) 88, 326  
 Anonymous class 365, 424  
 any? method  
 module Enumerable 433  
 Aoki, Minero 106  
 Aoyama, Wakou 72  
 Apache Web server 230  
 mod\_ruby 234  
 API  
 Microsoft Windows 254, 734  
 Ruby *see* Extend Ruby  
 APOP authentication 681  
 append\_features method  
 class Module 533  
 ARGF constant 170  
 ARGF variable 22, 321  
 Argument, command-line *see*  
 Command line  
 Argument, method 74, 75  
 ARGV variable 168–170, 321,  
 502, 663, 690  
 Arithmetic 671, 700  
 Arithmetic operations  
 method



- class Bignum 420
  - class Fixnum 463
  - class Float 466
  - arity method
    - class Method 522
    - class Proc 559
    - class UnboundMethod 631
  - Array
    - associative *see* Hash
    - creating 40
    - expanding as method
      - parameter 78, 333
    - indexing 41
    - literal 14, 307
    - method argument 332
  - Array class 357, 406
    - & 407
    - \* 407
    - + 407
    - 407
    - <=> 408
    - << 407
    - == 408
    - [ ] 41, 406, 408
    - [ ]= 41, 409
    - | 409
    - assoc 409
    - at 409
    - clear 410
    - collect! 410
    - compact 410
    - compact! 410
    - concat 410
    - delete 410
    - delete\_at 411
    - delete\_if 411
    - each 411
    - each\_index 411
    - empty? 411
    - eql? 411
    - fetch 412
    - fill 412
    - first 412
    - flatten 412
    - flatten! 413
    - include? 413
    - index 413
    - indexes 413
    - indices 413
    - insert 413
    - join 415
    - last 415
    - length 415
    - map! 415
    - new 406
    - nitems 415
    - pack 123, 414, 415
    - pop 416
    - push 416
    - rassoc 416
    - reject! 416
    - replace 416
    - reverse 416
    - reverse! 416
    - reverse\_each 417
    - rindex 417
    - scanf 708
    - shift 417
    - size 417
    - slice 417
    - slice! 418
    - sort 418
    - sort! 418
    - to\_a 418
    - to\_ary 418
    - to\_s 419
    - transpose 419
    - uniq 419
    - uniq! 419
    - unshift 419
    - values\_at 419
  - Array method
    - module Kernel 495
  - ASCII 302
    - character literal 56, 305
    - convert integer to 480
  - asctime method
    - class Time 623
  - asin method
    - module Math 519
  - asinh method
    - module Math 519
  - ASP *see* eruby
  - assert\_equal method 144
  - assert\_not\_nil method 148
  - Assertions *see* Test::Unit, assertions
  - Assignment 84, 323
    - attribute 335
    - parallel 85, 325
  - assoc method
    - class Array 409
  - Associative array *see* Hash
  - Asynchronous I/O 666
  - at method
    - class Array 409
    - class Time 621
  - at\_exit method
    - module Kernel 496
  - atan method
    - module Math 519
  - atan2 method
    - module Math 519
  - atanh method
    - module Math 519
  - atime method
    - class File::Stat 456
    - class File 444, 454
  - Atom *see* Symbol
  - attr method 339
    - class Module 533
  - attr\_accessor method 339
    - class Module 534
  - attr\_reader method 28, 339, 371
    - class Module 534
  - attr\_writer method 339
    - class Module 534
  - Attribute 27
    - assignment 159, 335
    - virtual 30
    - writable 29
    - see also* Class attribute
  - autoload method
    - class Module 526
    - module Kernel 496
  - autoload? method
    - class Module 526
    - module Kernel 497
  - Automation, Windows 255, 735
  - Autosplit mode 168
- ## B
- Backquote character *see* ```(backquote)
  - Backreferences (in regular expressions) 69–71, 311, 336
  - Backtrace *see* \$@, caller
  - backtrace method
    - class Exception 440
  - Backup files, creating 168
  - Base
    - number 422, 465, 601
  - Base (numeric) *see* to\_s methods, Kernel.Integer, String#to\_i
  - Base64 module 635
  - base\_uri method 686
  - basename method

- class File 444
  - BasicSocket class 119, 714, 741
    - close\_read 741
    - close\_write 741
    - do\_not\_reverse\_lookup 741
    - do\_not\_reverse\_lookup= 741
    - for\_fd 741
    - getpeername 741
    - getsockname 741
    - getsockopt 741
    - lookup\_order= 741
    - recv 742
    - send 742
    - setsockopt 742
    - shutdown 742
  - BEGIN {...} 303
  - begin method
    - class MatchData 516
    - class Range 577
  - =begin...=end 303
  - begin...end 95, 102, 325, 346
  - Benchmark module 162, 390, 636
  - Berger, Daniel 259
  - between? method
    - module Comparable 426
  - BigDecimal class 637
  - BigMath module 637
  - Bignum class 55, 420, 463, 637, 671
    - % 420
    - & 420
    - \* 420
    - \*\* 420
    - + 420
    - 420
    - @ 420
    - / 420
    - <=> 420
    - << 420
    - == 420
    - >> 420
    - [ ] 421
    - ^ 420
    - | 420
    - ~ 420
  - abs 421
  - Arithmetic operations 420
  - Bit operations 420
  - div 421
  - divmod 421
  - eql? 421
  - literal 55, 304
  - modulo 421
  - quo 421
  - remainder 422
  - size 422
  - to\_f 422
  - to\_s 422
  - Binary data 123, 306, 415, 602
  - Binary notation 55, 304
  - bind method
    - class Socket 746
    - class UDPSocket 751
    - class UnboundMethod 631
  - Binding
    - in block 318
    - GUI events 246
  - Binding class 322, 423
  - binding method
    - class Proc 560
    - module Kernel 390, 423, 497
  - binmode method
    - class IO 486
  - Bit operations method
    - class Bignum 420
    - class Fixnum 463
  - blksize method
    - class File::Stat 456
  - Block 19, 46, 341
    - break and next 342
    - as closure 52
    - and files 120
    - for busy cursor 249
    - fork, popen, and subprocess 142, 485, 504, 687
    - with method 389
    - as parameter to method 75, 333, 334
    - parameters 19, 48
    - return from 344
    - as transaction 50
    - variable scope 99, 128, 318
    - see also* Iterator
  - block\_given? method
    - module Kernel 51, 334, 497
  - blockdev? method
    - class File::Stat 456
    - class File 445
  - blocks method
    - class File::Stat 457
  - BlueCloth 206
  - Boolean expressions 326
    - see also* FalseClass, TrueClass
  - Bottlenecks 162
  - break 98, 330, 342
  - Breakpoint 155
  - Buffering problems 161
  - Bug *see* Testing
  - Build environment *see* Config module
  - Busy cursor 249
- ## C
- 
- c (Ruby option) 168
  - C *directory* (Ruby option) 168
  - C language *see* Extend Ruby
  - C language API
    - ALLOC 279
    - ALLOC\_N 279
    - ALLOCA\_N 280
    - Data\_Get\_Struct 271
    - Data\_Make\_Struct 271
    - Data\_Wrap\_Struct 271
    - OBJ\_FREEZE 298
    - OBJ\_FROZEN 299
    - OBJ\_TAINT 298
    - OBJ\_TAINTED 298
    - rb\_apply 295
    - rb\_ary\_entry 300
    - rb\_ary\_new 299
    - rb\_ary\_new2 299
    - rb\_ary\_new3 299
    - rb\_ary\_new4 299
    - rb\_ary\_pop 299
    - rb\_ary\_push 299
    - rb\_ary\_shift 299
    - rb\_ary\_store 299
    - rb\_ary\_unshift 300
    - rb\_block\_given\_p 297
    - rb\_bug 296
    - rb\_call\_super 295
    - rb\_catch 297
    - rb\_create\_new\_instance 295
    - rb\_cv\_get 298
    - rb\_cv\_set 298
    - rb\_cvar\_defined 298
    - rb\_cvar\_get 298
    - rb\_cvar\_set 298
    - rb\_define\_alias 293
    - rb\_define\_alloc\_func 293
    - rb\_define\_attr 295

- rb\_define\_class 291
- rb\_define\_class\_under 291
- rb\_define\_class\_variable 294
- rb\_define\_const 294
- rb\_define\_global\_const 294
- rb\_define\_global\_function 293
- rb\_define\_hooked\_variable 294
- rb\_define\_method 293
- rb\_define\_module 291
- rb\_define\_module\_function 293
- rb\_define\_module\_under 292
- rb\_define\_readonly\_variable 294
- rb\_define\_singleton\_method 293
- rb\_define\_variable 294
- rb\_define\_virtual\_variable 294
- rb\_each 297
- rb\_ensure 296
- rb\_exit 296
- rb\_extend\_object 292
- rb\_fatal 296
- rb\_funcall 295
- rb\_funcall2 295
- rb\_funcall3 295
- rb\_global\_variable 295
- rb\_gv\_get 298
- rb\_gv\_set 298
- rb\_hash\_aref 300
- rb\_hash\_aset 300
- rb\_hash\_new 300
- rb\_id2name 295
- rb\_include\_module 292
- rb\_intern 295
- rb\_iter\_break 297
- rb\_iterate 297
- rb\_iv\_get 297
- rb\_iv\_set 298
- rb\_ivar\_get 298
- rb\_ivar\_set 298
- rb\_load\_file 290
- rb\_notimplement 296
- rb\_obj\_is\_instance\_of 300
- rb\_obj\_is\_kind\_of 300
- rb\_protect 296
- rb\_raise 296
- rb\_require 292
- rb\_rescue 296
- rb\_respond\_to 300
- rb\_safe\_level 299
- rb\_scan\_args 293
- rb\_secure 299
- rb\_set\_safe\_level 299
- rb\_str\_cat 300
- rb\_str\_concat 300
- rb\_str\_dup 300
- rb\_str\_new 300
- rb\_str\_new2 300
- rb\_str\_split 300
- rb\_struct\_aref 292
- rb\_struct\_aset 292
- rb\_struct\_define 292
- rb\_struct\_new 292
- rb\_sys\_fail 296
- rb\_thread\_create 300
- rb\_throw 297
- rb\_undef\_method 293
- rb\_warn 297
- rb\_warning 297
- rb\_yield 297
- REALLOC\_N 280
- ruby\_finalize 290
- ruby\_init 290
- ruby\_init\_loadpath 290
- ruby\_options 290
- ruby\_run 290
- ruby\_script 290
- SafeStringValue 299
- call method
  - class Continuation 427
  - class Method 389, 522
  - class Proc 560
- :call-seq: (RDoc) 194, 197
- Callback
  - from GUI widget 243
  - Ruby runtime 392
  - see also* Block, closure
- callcc method
  - module Kernel 427, 497
- caller method
  - module Kernel 107, 393, 394, 497
- CamelCase 313
- capitalize method
  - class String 588
- capitalize! method
  - class String 588
- captures method
  - class MatchData 516
- case expression 92, 328
- Case insensitive
  - string comparison 589
- Case insensitive (regexp) 309
- casecmp method
  - class String 589
- casefold? method
  - class Regexp 581
- catch method
  - module Kernel 99, 108, 347, 498
- ceil method
  - class Float 467
  - class Integer 480
  - class Numeric 541
- center method
  - class String 589
- CFLAGS (mkmf) 756
- CGI class 223, 638
  - cookies 231
  - has\_key? 225
  - params 224
- CGI programming 222–240
  - cookies 231
  - embedding Ruby (eruby) 229
  - forms 224
  - generate HTML 225
  - mod\_ruby 234
  - query parameters 224
  - quoting 223
  - session 233
  - WEBrick 234
  - see also* Network protocols, Templates
- CGI::Session class 640
- CGIKit, Web framework 240
- change\_privilege method
  - module Process::GID 568
  - module Process::UID 575
- changed method
  - module Observable 685
- changed? method
  - module Observable 685
- Character
  - convert integer to 480
  - literal 56, 305

- Character class 67
- chardev? method
  - class File::Stat 457
  - class File 445
- charset method 686
- chdir method
  - class Dir 172, 428
- Checksum 600, 647
- Child process *see* Process
- chmod method
  - class File 445, 454
- chomp method
  - class String 59, 589
  - module Kernel 498
- chomp! method
  - class String 589
  - module Kernel 498
- chop method
  - class String 589, 668
  - module Kernel 499
- chop! method
  - class String 590, 668
  - module Kernel 499
- chown method
  - class File 445, 454
- chr method
  - class Integer 480
- chroot method
  - class Dir 429
- Class
  - anonymous 365, 424
  - attribute 27, 339
  - defining 337, 370
  - extending 24
  - generator 605
  - hierarchy 525
  - instance 10, 338
  - listing hierarchy 386
  - metaclass 363
  - method 32, 368
  - mixing in module 340
  - naming 14, 375
  - object specific 365
  - vs type 350
  - variable 31
  - virtual 364, 365
- Class class 362, 424
  - allocate 425
  - inherited 392, 424
  - new 338, 424, 425
  - superclass 386, 425
- class method
  - class Object 354, 546
- class\_eval method
  - class Module 526
- class\_variables method
  - class Module 527
- Classes
  - list of methods* 403
  - AF\_INET 667
  - Array 357, 406
  - BasicSocket 119, 714, 741
  - BigDecimal 637
  - Bignum 55, 420, 463, 637, 671
  - Binding 322, 423
  - CGI 223, 638
  - CGI::Session 640
  - Class 362, 424
  - Complex 641, 671
  - Continuation 427, 497
  - CSV 642
  - CSV::Row 642
  - Date 644
  - DateTime 644
  - DBM 645
  - Delegator 646
  - Dir 428, 693
  - DRb 649
  - ERB 652
  - Exception 101, 345, 440
  - FalseClass 443
  - File 119, 444, 462, 660, 693
  - File::Stat 456
  - Fixnum 55, 463, 671
  - Float 56, 466
  - GDBM 661
  - Generator 662
  - GetoptLong 663
  - GServer 664
  - Hash 357, 471
  - Iconv 665
  - Integer 357, 480, 671
  - IO 119, 357, 482, 655, 708, 714, 715
  - IPAddr 667
  - IPSocket 714, 747
  - Logger 669
  - Mail 670
  - MatchData 65, 73, 516, 579, 581, 587
  - MatchingData 516
  - Matrix 673
  - Method 389, 522, 534
  - Module 524
  - Monitor 134, 136, 717, 722
  - Mutex 675, 676
  - Net::FTP 677
  - Net::HTTP 678, 731
  - Net::IMAP 680
  - Net::POP3 681
  - Net::SMTP 682
  - Net::Telnet 683
  - NilClass 540
  - Numeric 541, 641
  - Object 27, 376, 546
  - OpenStruct 605, 689
  - OptionParser 690
  - Pathname 693
  - PP 694
  - PrettyPrint 505, 694, 695
  - Proc 53, 76, 342, 344, 357, 523, 534, 559
  - Process::Status 142, 566, 567, 570
  - PStore 698
  - Queue 133, 137, 722
  - Range 63, 307, 576
  - Rational 671, 700
  - Regexp 72, 579
  - SDBM 709
  - Set 407, 409, 710
  - SimpleDelegator 646
  - SizedQueue 722
  - Socket 714, 743
  - SOCKSSocket 714, 749
  - String 57, 305, 358, 585, 668, 708
  - StringIO 124, 715
  - StringScanner 716
  - Struct 605
  - Struct::Tms 609
  - Symbol 29, 323, 358, 594, 610
  - Sync 717
  - SyncEnumerator 662
  - Syslog 719
  - TCPServer 750
  - TCPsocket 714, 748
  - Tempfile 720
  - Test::Unit 721
  - Thread 612
  - ThreadGroup 615, 619
  - ThreadsWait 723
  - Time 444, 621, 724
  - Tk 726
  - TrueClass 629
  - UDPSocket 714, 751
  - UnboundMethod 389, 522, 523, 528, 630
  - UNIXServer 754

- UNIXSocket 714, 753
- URI 731
- Vector 673
- WeakRef 732
- Win32API 648, 734
- WIN32OLE 735
- clear method
  - class Array 410
  - class Hash 472
- Client/Server 398, 649, 664, 713
- clone method
  - class IO 486
  - class Module 527
  - class Object 274, 547
- close method
  - class Dir 431
  - class IO 486
  - class SOCKSSocket 749
- close\_read method
  - class BasicSocket 741
  - class IO 486
- close\_write method
  - class BasicSocket 741
  - class IO 487
- closed? method
  - class IO 487
- Closure 52, *see* Block
- Code profiler 163
- Coding system (ASCII, EUC, SJIS, UTF-8) 169, 302n, 306n, 665, 668, 684
- coerce method 358
  - class Numeric 358, 541
- Coercion 358
- Coffee coaster
  - attractive xxvii
- collect method
  - module Enumerable 49, 410, 433
- collect! method
  - class Array 410
- COM *see* Microsoft Windows, automation
- Comma-separated data 642
- Command (type of method) 77n
- Command expansion 83
  - see also* ` (backquote)
- Command line 121, 167
  - options 168–170
  - parsing 663, 690
  - see also* ARGV
- Command line, parsing 711
- Command, editing with readline 702
- Comment 302
  - for RDoc 187
  - regular expression 311
- Common Gateway Interface
  - see* CGI programming
- compact method
  - class Array 410
- compact! method
  - class Array 410
- Comparable module 112, 426
  - < 426
  - <= 426
  - == 426
  - > 426
  - >= 426
  - between? 426
  - Comparisons 426
- Comparison operators 326
  - see also* <=>
- Comparisons method
  - module Comparable 426
- compile method
  - class Regexp 579
- Completion, trb 176
- Complex class 641, 671
- Compression, gzip and zip 738
- COMSPEC 172, 500
- concat method
  - class Array 410
  - class String 590
- Condition variable *see* Thread, condition variable (and Thread, synchronization)
- Conditional expression 91, 328
  - see also* Range
- Config module 173
- CONFIGURE\_ARGS 755
- \$configure\_args variable 755
- connect method
  - class Socket 746
  - class UDPSocket 751
- const\_defined? method
  - class Module 527
- const\_get method
  - class Module 527
- const\_missing method
  - class Module 527
- const\_set method
  - class Module 528
- Constant 315
  - class name 375
  - listing in module 387
  - scope 315
- Constants
  - ARGF 170
  - DATA 303, 322
  - Errno 104
  - FALSE 322
  - false 87, 321, 326
  - \_\_FILE\_\_ 322
  - NIL 322
  - nil 14, 87, 321, 326
  - RUBY\_PLATFORM 322
  - RUBY\_RELEASE\_DATE 322
  - RUBY\_VERSION 322
  - SCRIPT\_LINES\_\_ 322, 395, 507
  - STDERR 322, 513
  - STDIN 322, 504
  - STDOUT 322, 504, 505
  - TOPLEVEL\_BINDING 322
  - TRUE 322
  - true 87, 322, 326
- constants method
  - class Module 524, 528
- Constructor 10, 23
  - initialize method 554
  - private 33
- Contact, authors' e-mail xxii
- Containers *see* Array and Hash
- content\_encoding method 686
- content\_type method 686
- Continuation class 427, 497
  - call 427
- Control character
  - \n etc. 56, 305, 306
- Conventions, typographic xxiv
- Conversion protocols 356
- Cookies *see* CGI programming, cookies
- cookies method
  - class CGI 231
- Cookies, HTTP 231
- Coordinated Universal Time 621
- copyright (Ruby option) 168
- CORBA *see* Distributed Ruby
- coredump? method
  - class Process::Status 570
- cos method
  - module Math 519
- cosh method

- module Math 519
- count method
  - class String 590
- count\_observers method
  - module Observable 685
- CPPFLAGS (mkmf) 756
- CPU times 609
- CRAM-MD5 authentication 680
- create\_makefile method
  - module mkmf 282, 757
- Critical section *see* Thread, synchronization
- critical method
  - class Thread 612
- critical= method
  - class Thread 133, 612
- crypt method
  - class String 590
- Cryptographic Hashes 647
- CSV class 642
- CSV::Row class 642
- ctime method
  - class File::Stat 457
  - class File 445, 454
  - class Time 623
- curdir (mkmf) 756
- Current directory 429
- current method
  - class Thread 613
- Curses module 643
- CVS access to Ruby 5
- CVSup 5
- cygwin32 253

## D

- d (Ruby option) 130, 321, 514
- d, --debug (Ruby option) 168
- \$\_d variable 321
- DATA constant 303, 322
- Data\_Get\_Struct 271
- Data\_Make\_Struct 271
- Data\_Wrap\_Struct 271
- Database *see* dbm, gdbm, qdbm, sdbm
- Datagram *see* Network protocols, UDP
- Date class 644
  - parsing 692
  - see also* Time class
- Date module 621
- DateTime class 644

- day method
  - class Time 623
- DBM class 645
- dbm 645
- DCOM *see* Microsoft Windows, automation
- Deadlock *see* Thread
- Debian installation 3
- \$DEBUG variable 168, 321, 612, 616
- Debug mode 130, 168
- Debugger 155
  - commands 165f
- Decimal notation 55, 304
- Decoupling 26
- Decoux, Guy 275
- def (method definition) 74
- Default (ThreadGroup constant) 619
- Default parameters 74, 332
- default method
  - class Hash 473
- default= method
  - class Hash 473
- default\_proc method
  - class Hash 473
- \$deferr variable 320
- define\_finalizer method
  - module ObjectSpace 557
- define\_method method
  - class Module 534
  - module Module 345
- defined? operator 88, 326
- \$defout variable 320
- Delegation 646, 659
- Delegator class 646
- delete method
  - class Array 410
  - class Dir 429
  - class File 445
  - class Hash 473
  - class String 590, 668
- delete! method
  - class String 591, 668
- delete\_at method
  - class Array 411
- delete\_if method
  - class Array 411
  - class Hash 474
- delete\_observer method
  - module Observable 685
- delete\_observers method
  - module Observable 685
- Delimited string 303

- Dependency, RubyGems 203
- Design Pattern *see* Patterns
- detach method
  - module Process 562
- detect method
  - module Enumerable 433
- Determinant, matrix 673
- dev method
  - class File::Stat 457
- dev\_major method
  - class File::Stat 457
- dev\_minor method
  - class File::Stat 457
- Dictionary *see* Hash
- DIG (Float constant) 466
- Digest module 647
- Dir
  - match modes 447f
- Dir class 428, 693
  - [ ] 428
  - chdir 172, 428
  - chroot 429
  - close 431
  - delete 429
  - each 431
  - entries 429
  - foreach 429
  - getwd 429
  - glob 430
  - mkdir 430
  - new 430
  - open 431
  - path 431
  - pos 431
  - pos= 432
  - pwd 431
  - read 432
  - rewind 432
  - rmdir 431
  - seek 432
  - tell 432
  - tmpdir 233, 727
  - unlink 431
  - see also* Find module
- dir\_config method
  - module mkmf 283, 757
- Directories
  - include and library for extensions 283
  - lib/ 282
  - pathname 693
  - search path 284
  - searched 173
  - temporary 727

- working 168
- directory? method
  - class File::Stat 457
  - class File 446
- dirname method
  - class File 446
- disable method
  - module GC 470
- disable-xxx (mkmf) 756
- Dispatch table 388
- display method
  - class Object 547
- Distributed Ruby 398, 649, 706, 736
- Distribution *see* RubyGems
- div method
  - class Bignum 421
  - class Fixnum 464
  - class Numeric 542
- Division, accuracy 671, 700
- divmod method
  - class Bignum 421
  - class Fixnum 464
  - class Float 467
  - class Numeric 544
- DL module 648
- DL library 259
- DLL, accessing API 254, 648, 734
- DLN\_LIBRARY\_PATH 172
- DNS 703
- do (in loops) 329
- do...end *see* Block
- do\_not\_reverse\_lookup
  - method
    - class BasicSocket 741
- do\_not\_reverse\_lookup=
  - method
    - class BasicSocket 741
- :doc: (RDoc) 194
- Document Type Definition 704
- Document-class: (RDoc) 197
- Document-method: (RDoc) 197
- Documentation
  - doc string example 372
  - embedded 187, 303
  - modifiers 193
  - see also* RDoc
- doGoogleSearch method 238
- Domain Name System 703
- Dotted quad *see* Network protocols
- Double dispatch 359

- Double-quoted string 57, 305
- downcase method
  - class String 591
- downcase! method
  - class String 591
- Download
  - Ruby 2
  - source from book 4
- Download Ruby
  - sites 759
- downto method
  - class Integer 96, 480
- dpkg installation 3
- DRb
  - see also* Distributed Ruby
- DRb class 649
- DRbUndumped module 649
- dst? method
  - class Time 623
- DTD 704
- Duck typing 280, 349–361
- \_dump 396, 514
- dump method
  - class String 591
  - module Marshal 395, 515
- dup method
  - class Object 274, 547
- Dynamic
  - compilation 499
  - definitions 370
  - linking 287, 648
  - method invocation 388
  - see also* Reflection

## E

- E (Math constant) 519
- e 'command' (Ruby option) 168
- E-mail
  - date/time formats 724
- each method 651
  - class Array 411
  - class Dir 431
  - class Hash 474
  - class IO 487
  - class Range 577
  - class String 591
  - class Struct 607
  - module Enumerable 49, 433
- each\_byte method
  - class IO 122, 487
  - class String 592
- each\_cons method 651
- each\_index method
  - class Array 411
- each\_key method
  - class Hash 474
- each\_line method
  - class IO 122, 488
  - class String 592
- each\_object method
  - module ObjectSpace 365, 385, 387, 557
- each\_pair method
  - class Hash 474
  - class Struct 607
- each\_slice method 651
- each\_value method
  - class Hash 474
- each\_with\_index method
  - module Enumerable 434
- Editor
  - run Ruby in 157
- egid method
  - module Process 563
- egid= method
  - module Process 563
- eid method
  - module Process::GID 568
  - module Process::UID 575
- eid= method
  - module Process::GID 568
  - module Process::UID 575
- Eiffel
  - once modifier 374
- Element reference ([ ]) 336
- else (exceptions) 105, 347
  - see also* if, case
- elsif 328
- Emacs 157
  - tag file 185
- Emacs key binding 702
- E-mail
  - address for feedback xxii
  - fetching with IMAP 680
  - fetching with POP 681
  - parsing 670
  - sending with SMTP 682
- Embed Ruby
  - in HTML etc. *see* eruby
  - interpreter in application 287
- Embedded documentation 187, 303
- empty? method
  - class Array 411
  - class Hash 474
  - class String 592



- enable method
  - module GC 470
- enable-xxx (mkmf) 756
- enable\_config method
  - module mkmf 757
- enclose method
  - class ThreadGroup 619
- enclosed? method
  - class ThreadGroup 620
- Encodings, character 665, 668, 684
- Encryption 590
- \_\_END\_\_ 303, 322
- END {...} 303
- End of line 122
- end method
  - class MatchData 517
  - class Range 577
- :enddoc: (RDoc) 195
- English library 650
- English names for \$ variables 318, 650
- ensure (exceptions) 105, 347
- entries method
  - class Dir 429
  - module Enumerable 434
- enum\_for method 651
- Enumerable class
  - Enumerator 651
- Enumerable module 49, 113, 433, 651, 662
  - all? 433
  - any? 433
  - collect 49, 410, 433
  - convert to Set 710
  - detect 433
  - each 49, 433
  - each\_with\_index 434
  - entries 434
  - find 434
  - find\_all 434
  - grep 434
  - include? 434
  - inject 49, 113, 435
  - map 435
  - max 435
  - member? 435
  - min 435
  - partition 436
  - reject 416, 436
  - select 436
  - sort 436
  - sort\_by 436
  - to\_a 438
  - zip 438
- Enumerator module 651
- ENV variable 171, 321
- Environment variables 171
  - COMSPEC 172, 500
  - DLN\_LIBRARY\_PATH 172
  - HOME 172, 428, 446
  - LOGDIR 172, 428
  - OPENSSL\_CONF 172
  - PATH 169
  - POSIXLY\_CORRECT 663
  - RI 8, 202
  - RUBY\_TCL\_DLL 172
  - RUBY\_TK\_DLL 172
  - RUBYLIB 172, 173, 383
  - RUBYLIB\_PREFIX 172
  - RUBYOPT 172, 383
  - RUBYPATH 169, 172
  - RUBYSHELL 172, 500
  - SHELL 172
- see also* ENV variable
- eof method
  - class IO 488
- eof? method
  - class IO 488
- Epoch 621
- EPSILON (Float constant) 466
- eql? method 89
  - class Array 411
  - class Bignum 421
  - class Float 467
  - class Method 522
  - class Numeric 544
  - class Object 547
  - class Range 578
  - class String 592
- equal? method 89
  - class Object 548
- ERB class 652
- erb 229, 652
- ERB::Util module 653
- erf method
  - module Math 520
- erfc method
  - module Math 520
- Errno constant 104
- Errno module 104, 439, 440
- Error handling *see* Exception
- Errors in book, reporting xxii
- eruby 229–231
  - in Apache 230
- see also* CGI programming
- escape method
  - class Regexp 579
- Escaping characters *see* Quoting
- Etc module 654
- EUC 302, 309, 665, 668, 684
- eid method
  - module Process 563
- eid= method
  - module Process 563
- eval method
  - module Kernel 389, 423, 499
- Event binding *see* GUI programming
- Example code, download 4
- Example printer 186
- Exception 101–109, 345
  - ClassCastException 350
  - EOFError 701
  - in extensions 296
  - FaultException 736
  - handling 102
  - hierarchy 103f
  - IndexError 412, 588
  - LoadError 210
  - LocalJumpError 344
  - NameError 318, 348
  - raising 106, 506
  - RuntimeError 107, 345
  - SecurityError 379
  - StandardError 102, 104, 346
  - stored in \$! 319
  - SystemCallError 104, 439, 500, 510
  - SystemExit 170, 441, 442, 500
  - testing 147
  - in thread 130, 612
  - ThreadError 344
  - Timeout::Error 725
  - TruncatedDataError 701
  - TypeError 38, 266, 396, 495
- Exception class 101, 345, 440
  - backtrace 440
  - exception 440
  - message 441
  - new 440
  - set\_backtrace 441
  - status 441
  - success? 442
  - to\_s 442
  - to\_str 442
- exception method



- class Exception 440
- exclUde\_end? method
  - class Range 578
- exec method
  - module Kernel 141, 485, 500
- executable? method
  - class File::Stat 458
  - class File 446
- executable\_real? method
  - class File::Stat 458
  - class File 446
- Execution
  - environment 376
  - profiler 163
  - tracing 393
- exist? method
  - class File 446
- exists? method
  - class File 446
- Exit status *see* \$?
- exit method
  - class Thread 613, 615
  - module Kernel 170, 441, 500
  - module Process 563
- exit! method
  - module Kernel 501
  - module Process 563
- exited? method
  - class Process::Status 571
- exitstatus method
  - class Process::Status 571
- exp method
  - module Math 520
- expand\_path method
  - class File 446
- expect library 655
- expect method
  - class IO 655, 699
- \$expect\_verbose variable 655
- Expression 81–100, 323–330
  - boolean 87, 326
  - case 92, 328
  - if 90, 328
  - range as boolean 89
  - substitution in string 306
  - ternary 91, 328
  - unless *see* if
- extconf.rb 263, 282
  - see also* mkmf module

- Extend Ruby 261–301, 755
  - allocation 273
  - building extensions 282
    - see also* mkmf module
  - call method API 295
  - clone and dup 274
  - create object 262, 273
  - data type conversion API 266
  - data type wrapping API 271
  - define classes API 291
  - define methods API 292
  - define structures API 292
  - documentation (RDoc) 195
  - embedded Ruby API 290
  - embedding 287
  - example code 276
  - exception API 296
  - garbage collection 271
  - initialize 262
  - internal types 264
  - iterator API 297
  - linking 287
  - memory allocation API 279
  - object status API 298
  - strings 266
  - variable API 294, 297
  - variables 269
- extend method
  - class Object 366, 368, 548
- extend\_object method
  - class Module 392, 535
- EXTENDED (Regexp constant) 579
- Extended mode (regexp) 309
- extended method
  - class Module 535
- Extending classes 24
- External iterator 50, 662
- extname method
  - class File 446

## F

- \$F variable 168, 321
- F *pattern* (Ruby option) 168, 319
- \$F variable 320
- Factory method 34
- fail method
  - module Kernel 106, 501
- FALSE constant 322
- false constant 87, 321, 326
- FalseClass class 443

- & 443
- ^ 443
- | 443
- Fcntl module 488, 656
- fcntl method
  - class IO 488
- FD (file descriptor) 486
- Feedback, e-mail address xxii
- fetch method
  - class Array 412
  - class Hash 475
- Fibonacci series (fib\_up\_to) 47
- Field separator *see* \$;
- \_\_FILE\_\_ constant 322
- File
  - associations under Windows 254
  - and blocks 120
  - descriptor 486
  - directory operations *see* Dir class
  - directory traversal 658
  - expanding names 446, 447
  - FNМ\_NOESCAPE 447
  - including source 117, 168, 172
  - lock modes 455f
  - match modes 447f
  - modes 483f
  - open modes 451f
  - opening 120
  - owner 445, 454, 458, 460, 461
  - pathname 449f, 482, 693
  - permission 444, 453
  - reading 121
  - temporary 720
  - tests 510
  - writing 123
- File class 119, 444, 462, 660, 693
  - atime 444, 454
  - basename 444
  - blockdev? 445
  - chardev? 445
  - chmod 445, 454
  - chown 445, 454
  - ctime 445, 454
  - delete 445
  - directory? 446
  - dirname 446
  - executable? 446
  - executable\_real? 446

exist? 446  
 exists? 446  
 expand\_path 446  
 extname 446  
 file? 447  
 flock 454  
 fnmatch 430, 447  
 fnmatch? 448  
 ftools extension 660  
 ftype 448  
 grpowned? 448  
 join 448  
 lchmod 448, 454  
 lchown 449, 454  
 link 449  
 lstat 449, 455  
 mtime 449, 455  
 new 120, 449  
 open 51, 120, 450  
 owned? 450  
 path 455  
 pipe? 450  
 readable? 450  
 readable\_real? 450  
 readlink 450  
 rename 451  
 setgid? 451  
 setuid? 451  
 size 451  
 size? 451  
 socket? 452  
 split 452  
 stat 452  
 sticky? 452  
 symlink 452  
 symlink? 452  
 truncate 452, 455  
 umask 453  
 unlink 453  
 utime 453  
 writable? 453  
 writable\_real? 453  
 zero? 453  
 File Transfer Protocol *see*  
     Network protocols, FTP  
 File, reading 701  
 File::Stat class 456  
     <=> 456  
     atime 456  
     blksize 456  
     blockdev? 456  
     blocks 457  
     chardev? 457  
     ctime 457

dev 457  
 dev\_major 457  
 dev\_minor 457  
 directory? 457  
 executable? 458  
 executable\_real? 458  
 file? 458  
 ftype 458  
 gid 458  
 grpowned? 458  
 ino 458  
 mode 458  
 mtime 459  
 nlink 459  
 owned? 459  
 pipe? 459  
 rdev 459  
 rdev\_major 459  
 rdev\_minor 459  
 readable? 459  
 readable\_real? 460  
 setgid? 460  
 setuid? 460  
 size 460  
 size? 460  
 socket? 460  
 sticky? 460  
 symlink? 461  
 uid 461  
 writable? 461  
 writable\_real? 461  
 zero? 461  
 file? method  
     class File::Stat 458  
     class File 447  
 \$FILENAME variable 321  
 fileno method  
     class IO 488  
 FileTest module 462, 693  
 FileUtils module 657, 730  
 fill method  
     class Array 412  
 Find module 658  
 find method  
     module Enumerable 434  
 find\_all method  
     module Enumerable 434  
 find\_library method  
     module mkmf 285, 757  
 Finger client 125  
 finite? method  
     class Float 467  
 first method  
     class Array 412

class Range 578  
 Fixnum class 55, 463, 671  
     % 463  
     & 463  
     \* 463  
     \*\* 463  
     + 463  
     - 463  
     -@ 463  
     / 463  
     <=> 463  
     << 463  
     >> 463  
     [ ] 464  
     ^ 463  
     | 463  
     ~ 463  
 abs 464  
 Arithmetic operations  
     463  
 Bit operations 463  
 div 464  
 divmod 464  
 id2name 464  
 literal 55, 304  
 modulo 464  
 quo 464  
 range of 55  
 size 465  
 to\_f 465  
 to\_s 465  
 to\_sym 465  
 zero? 465  
 flatten method  
     class Array 412  
 flatten! method  
     class Array 413  
 Float class 56, 466  
     % 466  
     \* 466  
     \*\* 466  
     + 466  
     - 466  
     -@ 466  
     / 466  
     <=> 466  
     == 467  
     abs 467  
     Arithmetic operations  
         466  
     ceil 467  
     divmod 467  
     eql? 467  
     finite? 467

- floor 467
- infinite? 468
- literal 56, 305
- modulo 468
- nan? 468
- round 468
- to\_f 468
- to\_i 468
- to\_int 468
- to\_s 469
- truncate 469
- zero? 469
- Float method
  - module Kernel 495, 600
- flock method
  - class File 454
- floor method
  - class Float 467
  - class Integer 480
  - class Numeric 544
- flush method
  - class IO 488
- FN\*\_xxx
  - filename match constants 447
- fnmatch method
  - class File 430, 447
- fnmatch? method
  - class File 448
- for...in loop 97, 329, 651
- for\_fd method
  - class BasicSocket 741
  - class IO 483
- foreach method
  - class Dir 429
  - class IO 123, 483
- Fork *see* Process
- fork method
  - class Thread 613
  - module Kernel 141, 142, 501
  - module Process 563
- format method
  - module Kernel 502
- Forms *see* CGI programming, forms
- Forms (Web) 224
- Fortran, documentation 187n
- Forwardable module 659
- Forwarding 646, 659
- Fowler, Chad xxiii, 203
- freeze method
  - class Object 162, 377, 548
  - class ThreadGroup 620

- frexp method
  - module Math 520
- frozen? method
  - class Object 549
- fsync method
  - class IO 488
- ftools library 660
- FTP *see* Network protocols, FTP
- FTP site for Ruby 2
- ftype method
  - class File::Stat 458
  - class File 448
- Funaba, Tadayoshi 373
- Function *see* Method
- Function pointer 389

## G

- Garbage collection 353, 470, 557, 732
  - internals 271
- garbage\_collect method
  - module GC 470
  - module ObjectSpace 558
- GC module 470
  - disable 470
  - enable 470
  - garbage\_collect 470
  - start 470
- GDBM class 661
- gdbm 645, 661
- Gelernter, David 706
- Gem *see* RubyGems
- gem\_server 208
- gemspec 212–214
- General delimited string 303
- Generator class 662
- Generator library 50
- Geometry management 246
- get method 678
- getaddress method
  - class IPSocket 747
- getaddrinfo method
  - class Socket 744
- getc method
  - class IO 489
- getegid method
  - module Process::Sys 573
- geteuid method
  - module Process::Sys 573
- getgid method
  - module Process::Sys 573
- getgm method
  - class Time 624
- gethostbyaddr method
  - class Socket 744
- gethostbyname method
  - class Socket 744
  - class TCPSocket 748
- gethostname method
  - class Socket 744
- getlocal method
  - class Time 624
- getnameinfo method
  - class Socket 745
- GetoptLong class 663
- getpeername method
  - class BasicSocket 741
- getpgid method
  - module Process 563
- getpgrp method
  - module Process 563
- getpriority method
  - module Process 564
- gets method
  - class IO 489
  - module Kernel 320, 502
- getservbyname method
  - class Socket 745
- getsockname method
  - class BasicSocket 741
- getsockopt method
  - class BasicSocket 741
- Getter method 27
- getuid method
  - module Process::Sys 573
- getutcb method
  - class Time 624
- getwd method
  - class Dir 429
- gid method
  - class File::Stat 458
  - module Process 564
- gid= method
  - module Process 564
- GIF 246, 250
- Glob *see* File, expanding names
- glob method
  - class Dir 430
- Global variables *see* Variables
- global\_variables method
  - module Kernel 502
- gm method
  - class Time 621
- GMT 621
- gmt? method
  - class Time 624

gmt\_offset method  
 class Time 624

gmtime method  
 class Time 624

gmtoff method  
 class Time 625

GNU readline 702

Google  
 developer key 238  
 Web API 238  
 WSDL 239

Granger, Michael 206

grant\_privilege method  
 module Process::GID 568  
 module Process::UID 575

Graphic User Interface *see* GUI programming

Greedy patterns 69

Greenwich Mean Time 621

grep method  
 module Enumerable 434

group method  
 class Thread 615

Grouping (regular expression) 69

groups method  
 module Process 564, 565

groups= method  
 module Process 564, 565

grpowned? method  
 class File::Stat 458  
 class File 448

GServer class 664

gsub method  
 class String 70, 311, 592  
 module Kernel 502

gsub! method  
 class String 311, 593  
 module Kernel 502

GUI programming 241–252, 726  
 callback from widget 243  
 events 246  
 geometry management 246  
 scrolling 249  
 widgets 242–245

GZip compression 738

## H

-h, --help (Ruby option) 168

has\_key? method  
 class CGI 225  
 class Hash 475

has\_value? method  
 class Hash 475

Hash 42  
 creating 43  
 default value 16  
 indexing 43  
 key requirements 308  
 literal 15, 307  
 as method parameter 79, 333

Hash class 357, 471  
 == 472  
 [ ] 471, 472  
 [ ]= 472  
 => 43  
 clear 472  
 default 473  
 default= 473  
 default\_proc 473  
 delete 473  
 delete\_if 474  
 each 474  
 each\_key 474  
 each\_pair 474  
 each\_value 474  
 empty? 474  
 fetch 475  
 has\_key? 475  
 has\_value? 475  
 include? 475  
 index 475  
 indexes 476  
 indices 476  
 invert 476  
 key? 476  
 keys 476  
 length 476  
 member? 476  
 merge 476  
 merge! 477  
 new 471  
 rehash 308, 477  
 reject 477  
 reject! 477  
 replace 357, 477  
 select 478  
 shift 478  
 size 478  
 sort 478  
 store 478  
 to\_a 478  
 to\_hash 478  
 to\_s 478  
 update 479  
 value? 479

values 479  
 values\_at 479

Hash functions 647

hash method  
 class Object 549

have\_func method  
 module mkmf 286, 757

have\_header method  
 module mkmf 285, 757

have\_library method  
 module mkmf 285, 757

head method 678

Heading, RDoc 193

Here document 58, 306

Hex notation 55, 304

hex method  
 class String 593

Hintze, Clemens 314

HOME 172, 428, 446

Hook 391

hour method  
 class Time 625

Howard, Ara T. 699

HTML *see* CGI programming

HTML, documentation 187

HTTP *see* Network protocols, HTTP

HTTPS protocol 688

Hyperlink in documentation 192

hypot method  
 module Math 520

---

**I**

/i regexp option 309

-i [*extension*] (Ruby option) 168, 321

-I *directories* (Ruby option) 168, 320

\$\_I variable 321

\$\_i variable 321

Ichikawa, Itaru 684

Iconv class 665

id method  
 class Object 549

id2name method  
 class Fixnum 464  
 class Symbol 610

Identifier  
 object ID 10, 386  
*see also* Variable

IEEE floating point 466

-Idirectories (Ruby option) 173

- if expression 90, 328
  - as modifier 91, 328
- IGNORECASE (Regexp constant) 579
- Igpay atinlay *see* Pig latin
- in (for loop) 329
- In-place edit mode 168
- :include: (RDoc) 194
- include method 112
  - class Module 340, 535
- include? method
  - class Array 413
  - class Hash 475
  - class Module 528
  - class Range 578
  - class String 593
  - module Enumerable 434
- included method
  - class Module 535
- included\_modules method
  - class Module 528
- Including source files *see* File, including source
- Incremental development 162
- Indentation 12
- index method
  - class Array 413
  - class Hash 475
  - class String 311, 593
- indexes method
  - class Array 413
  - class Hash 476
- Indexing
  - array 41
  - hash 43
- indices method
  - class Array 413
  - class Hash 476
- infinite? method
  - class Float 468
- Inheritance 25, 337
  - and access control 376
  - method lookup 334, 363
  - single *versus* multiple 28
    - see also* Delegation; Module, mixin
- inherited method
  - class Class 392, 424
- initgroups method
  - module Process 564
- initialize method 23, 35, 338
  - class Object 554
- initialize\_copy method
  - class Object 275, 549
- inject method 49
  - module Enumerable 49, 113, 435
- ino method
  - class File::Stat 458
- Input/Output *see* I/O
- insert method
  - class Array 413
  - class String 594
- inspect method
  - class Object 549, 694
  - class Regexp 581
  - class Symbol 611
- Installation script 657, 730
- Installing Ruby 2
- Instance
  - class instance method *see* Object method method *see* Method variable *see* Variable
- instance\_eval method
  - class Object 549
- instance\_method method
  - class Module 528, 630
- instance\_methods method
  - class Module 529
- instance\_of? method
  - class Object 550
- instance\_variable\_get method
  - class Object 550
- instance\_variable\_set method
  - class Object 550
- instance\_variables method
  - class Object 550
- Integer class 357, 480, 671
  - ceil 480
  - chr 480
  - downto 96, 480
  - floor 480
  - integer? 480
  - next 480
  - round 480
  - succ 481
  - times 96, 481
  - to\_i 481
  - to\_int 481
  - truncate 481
  - upto 96, 481
    - see also* Fixnum, Bignum
- Integer method
  - module Kernel 357, 495
- integer? method
  - class Integer 480
  - class Numeric 544
- Interactive Ruby *see* irb
- Intern *see* Symbol
- intern method
  - class String 594
- Internal iterator 50
- Internet *see* Network protocols
- Internet Mail Access Protocol (IMAP) *see* Network protocols, IMAP
- Interval *see* Range
- Introspection *see* Reflection
- Inverse, matrix 673
- invert method
  - class Hash 476
- Invoking *see* Method, calling
- IO class 119, 357, 482, 655, 708, 714, 715
  - << 124, 486
  - binmode 486
  - clone 486
  - close 486
  - close\_read 486
  - close\_write 487
  - closed? 487
  - each 487
  - each\_byte 122, 487
  - each\_line 122, 488
  - eof 488
  - eof? 488
  - expect 655, 699
  - fcntl 488
  - fileno 488
  - flush 488
  - for\_fd 483
  - foreach 123, 483
  - fsync 488
  - getc 489
  - gets 489
  - ioctl 489
  - isatty 489
  - lineno 489
  - lineno= 490
  - new 483
  - open 484
  - pid 490
  - pipe 141, 484
  - popen 140, 484
  - pos 490
  - pos= 490
  - print 490
  - printf 491

puts 491  
 puts 491  
 read 485, 491  
 readbytes 701  
 readchar 491  
 readline 491  
 readlines 485, 492  
 ready? 666  
 reopen 357, 492  
 rewind 492  
 seek 492  
 select 357, 486  
 stat 492  
 StringIO 715  
 sync 493  
 sync= 493  
 sysopen 486  
 sysread 493  
 sysseek 493  
 syswrite 493  
 tell 494  
 to\_i 494  
 to\_io 494  
 tty? 494  
 ungetc 494  
 wait 666  
 write 494  
 I/O 119–126  
   binary data 123  
   buffering problems 161  
     *see also* classes File, IO,  
     and Network Protocols  
   io/wait library 666  
   ioctl method  
     class IO 489  
   Iowa, Web framework 226  
   IP address representation 667  
   IP, IPv4, IPv6 *see* Network  
     protocols  
   IPAddr class 667  
   IPSocket class 714, 747  
     addr 747  
     getaddress 747  
     peeraddr 747  
     recvfrom 747  
   irb 5, 156, 174–185  
     commands 183  
     configuration 179  
     extending 180  
     load files into 176  
     options 175f  
     prompt 179, 184  
     adding ri 180  
     subsession 177

    tab completion 176  
   .irbrc, \_irbrc, irb.rc,  
     \$irbrc 179  
   is\_a? method  
     class Object 550  
   isatty method  
     class IO 489  
   isdst method  
     class Time 625  
   ISO 8601 date 692, 724  
   issetugid method  
     module Process::Sys 573  
   Iterator 19, 46, 95  
     on arbitrary method 651  
     in extension 297  
     external, internal 50, 662  
     for reading files 122  
       *see also* Block  
   iterator? method  
     module Kernel 503

## J

JavaSpaces *see* Distributed  
   Ruby  
 jcode library 668  
 JINI *see* Distributed Ruby  
 JIS 302, 665, 668, 684  
 join method  
   class Array 415  
   class File 448  
   class Thread 129, 615  
 JSP *see* eruby  
 Jukebox example 23–32, 52–54,  
   270–279

## K

-K *kcode* (Ruby option) 169,  
   321  
 \$-K variable 321  
 Kanji 684  
 \$KCODE variable 309, 638, 668  
 kcode method  
   class Regexp 581  
 Kellner, Robert 722  
 Kernel module 495  
   ` (backquote) 83, 140,  
   495  
   abort 496  
   alias\_method 391  
   Array 495  
   at\_exit 496  
   autoload 496  
   autoload? 497

  binding 390, 423, 497  
   block\_given? 51, 334, 497  
   callcc 427, 497  
   caller 107, 393, 394, 497  
   catch 99, 108, 347, 498  
   chomp 498  
   chomp! 498  
   chop 499  
   chop! 499  
   eval 389, 423, 499  
   exec 141, 485, 500  
   exit 170, 441, 500  
   exit! 501  
   fail 106, 501  
   Float 495, 600  
   fork 141, 142, 501  
   format 502  
   gets 320, 502  
   global\_variables 502  
   gsub 502  
   gsub! 502  
   Integer 357, 495  
   iterator? 503  
   lambda 53, 343, 345, 503,  
   560  
   load 172, 320, 380, 503  
   local\_variables 503  
   loop 96, 503  
   method\_missing 334, 362  
   open 126, 504, 686  
   p 505  
   pp 694  
   print 320, 505  
   printf 320, 505  
   proc 343, 345, 506  
   putc 506  
   puts 506  
   raise 106, 345, 506  
   rand 506  
   readline 320, 506  
   readlines 507  
   require 172, 320, 507, 526  
   scan 507  
   scanf 708  
   select 507  
   set\_trace\_func 393, 423,  
   508, 728  
   singleton\_method\_added  
   392  
   singleton\_method\_  
   removed  
   392

singleton\_method\_undefined 392  
 sleep 508  
 split 168, 508  
 sprintf 508  
 srand 509  
 String 495  
 sub 509  
 sub! 509  
 syscall 509  
 system 140, 509  
 test 510  
 throw 108, 347, 510  
 trace\_var 511  
 trap 142, 513  
 untrace\_var 513  
 warn 169, 321, 513  
   *see also* Object class  
 key? method  
   class Hash 476  
   class Thread 616  
 keys method  
   class Hash 476  
   class Thread 616  
 Keyword argument 79  
 Keywords 314  
 kill method  
   class Thread 613, 616  
   module Process 564  
 kind\_of? method  
   class Object 551

## L

-l (Ruby option) 169, 321  
 \$-l variable 321  
 lambda method  
   module Kernel 53, 343, 345, 503, 560  
 last method  
   class Array 415  
   class Range 578  
 last\_match method  
   class Regexp 579  
 last\_modified method 686  
 Latent types *see* Duck typing  
 Layout, source code 302  
 lchmod method  
   class File 448, 454  
 lchown method  
   class File 449, 454  
 ldxp method  
   module Math 520

LD\_FLAGS (mkmf) 756  
 Leap seconds 626n  
 Leap year 92  
 length method  
   class Array 415  
   class Hash 476  
   class MatchData 517  
   class String 594  
   class Struct 608  
 Library  
   Abbrev 634  
   Base64 635  
   Benchmark 636  
   BigDecimal 637  
   BigMath 637  
   CGI 638  
   CGI::Session 640  
   Complex 641  
   CSV 642  
   CSV::Row 642  
   Curses 643  
   Date 644  
   DateTime 644  
   DBM 645  
   Delegator 646  
   Digest 647  
   DL 259, 648  
   DRb 649  
   English 650  
   Enumerator 651  
   ERB 652  
   expect 655  
   Fcntl 656  
   FileUtils 657  
   Find 658  
   Forwardable 659  
   ftools 660  
   GDBM 661  
   Generator 50, 662  
   GetoptLong 663  
   GServer 664  
   Iconv 665  
   io/wait 666  
   IPAddr 667  
   jcode 668  
   Logger 669  
   Mail 670  
   mathn 182, 671, 700  
   Matrix 673  
   mkmf 755  
   Monitor 674  
   monitor 134  
   MonitorMixin 674  
   Mutex 675

Mutex\_m 676  
 net/http 128  
 Net::FTP 677  
 Net::HTTP 678  
 Net::IMAP 680  
 Net::POP3 681  
 Net::SMTP 682  
 Net::Telnet 683  
 NKF 684  
 Observable 685  
 open-uri 126, 686  
 Open3 687  
 OpenSSL 688  
 OpenStruct 689  
 OptionParser 690  
 ParseDate 692  
 Pathname 693  
 PP 694  
 PrettyPrint 695  
 profile 163, 696  
 Profiler\_ 697  
 PStore 698  
 PTY 699  
 Queue 722  
 Rational 700  
 readbytes 701  
 Readline 702  
 readline 155, 176, 182  
 resolv 703  
 resolv-replace 703  
 REXML 704  
 Rinda 706  
 RSS 707  
 scanf 708  
 SDBM 709  
 Set 710  
 Shellwords 711  
 SimpleDelegator 646  
 Singleton 712  
 SizedQueue 722  
 SOAP 713  
 Socket 714  
 standard 632–738  
 StringIO 715  
 StringScanner 716  
 Sync 717  
 SyncEnumerator 662  
 Syslog 719  
 Tempfile 720  
 Test::Unit 721  
 thread 133, 137  
 ThreadsWait 723  
 time 724  
 Timeout 725

Tk 726  
 tmpdir 720, 727  
 tracer 728  
 TSort 729  
 un 730  
 URI 731  
 Vector 673  
 WeakRef 732  
 WEBrick 733  
 Win32API 254, 734  
 WIN32OLE 255, 735  
 XMLRPC 736  
 YAML 397, 514, 633, 737  
 Zlib 738  
   *see also* RubyGems  
 lib/ directory 282  
 Linda *see* Distributed Ruby,  
   Rinda  
 Line continuation 302  
 Line separator *see* End of line  
 lineno method  
   class IO 489  
 lineno= method  
   class IO 490  
 link method  
   class File 449  
 List *see* Array  
   RDoc 192  
 list method  
   class ThreadGroup 620  
   class Thread 613  
   module Signal 583  
 listen method  
   class Socket 746  
 Listener *see* Observer  
 Literal  
   array 307  
   ASCII 56, 305  
   Bignum 55, 304  
   Fixnum 55, 304  
   Float 56, 305  
   hash 307  
   range 62, 307  
   regular expression 64, 309  
   String 57, 305  
   symbol 308  
 ljust method  
   class String 594  
 \_load 396, 514  
 load method 112, 117  
   module Kernel 172, 320,  
     380, 503  
   module Marshal 395, 396,  
     515

\$LOAD\_PATH variable 152, 168,  
   175, 209–211, 213, 216,  
   321  
 Local variable *see* Variable  
 local method  
   class Time 622  
 local\_variables method  
   module Kernel 503  
 localtime method  
   class Time 625  
 Locking *see* File class, flock  
 Locking (file) 454  
 log method  
   module Math 520  
 log10 method  
   module Math 520  
 LOGDIR 172, 428  
 Logger  
   system 719  
 Logger class 669  
 lookup\_order= method  
   class BasicSocket 741  
 Loop 480, 481, 545  
   *see also* Iterator  
 loop method 96, 329  
   module Kernel 96, 503  
 lstat method  
   class File 449, 455  
 lstrip method  
   class String 594  
 lstrip! method  
   class String 594  
 Lvalue 84, 323

## M

/m regexp option 309  
 Macdonald, Ian 240  
 Maeda, Shugo 229  
 Mail class 670  
 Mailing lists 759  
 :main: (RDoc) 195  
 Main program 376  
 main method  
   class Thread 613  
 MAJOR\_VERSION (Marshal  
   constant) 515  
 MANIFEST file 287  
 MANT\_DIG (Float constant) 466  
 map method  
   module Enumerable 435  
 map! method  
   class Array 415  
 Marshal module 395–397,  
   514–515  
   dump 395, 515  
   limitations 514  
   load 395, 396, 515  
   restore 515  
   *see also* YAML  
 marshal\_dump method 396,  
   514  
 marshal\_load method 514  
 match method  
   class Regexp 65, 73, 581  
   class String 595  
 MatchData class 65, 73, 516,  
   579, 581, 587  
   [ ] 516  
   begin 516  
   captures 516  
   end 517  
   length 517  
   offset 517  
   post\_match 517  
   pre\_match 517  
   select 517  
   size 517  
   string 518  
   to\_a 518  
   to\_s 518  
   values\_at 518  
   *see also* ~-  
 MatchingData class 516  
 Math module 519  
   acos 519  
   acosh 519  
   asin 519  
   asinh 519  
   atan 519  
   atan2 519  
   atanh 519  
   cos 519  
   cosh 519  
   erf 520  
   erfc 520  
   exp 520  
   frexp 520  
   hypot 520  
   ldexp 520  
   log 520  
   log10 520  
   sin 520  
   sinh 521  
   sqrt 521  
   tan 521  
   tanh 521



- mathn library 182, 671, 700
- Matrix class 673
- Matsumoto, Yukihiro xviii, xix, xxiii, 72
- Matz *see* Matsumoto, Yukihiro
- MAX (Float constant) 466
- max method
  - module Enumerable 435
- MAX\_10\_EXP (Float constant) 466
- MAX\_EXP (Float constant) 466
- maxgroups method
  - module Process 565
- maxgroups= method
  - module Process 565
- mbox (e-mail file) 670
- MD5 hash 647
- mday method
  - class Time 625
- member? method
  - class Hash 476
  - class Range 578
  - module Enumerable 435
- members method
  - class Struct 606, 608
- merge method
  - class Hash 476
- merge! method
  - class Hash 477
- Message
  - receiver 11
  - sending 10, 26
- Message box, Windows 259
- message method
  - class Exception 441
- Meta character 56, 305
- meta method 686
- Metaclass 363, 365
- Metaprogramming *see* Reflection
- Method 80
  - access control 35, 530, 532, 537, 538
  - aliasing 336
  - ambiguity 116
  - arguments 332
  - array parameter 78
  - block as parameter 75
  - call, in extension 295
  - calling 76, 333
  - calling dynamically 388
  - class 32, 368
  - defining 74, 75, 330
  - in extension 292
  - getter 27
  - instance 10
  - with iterator 389
  - keyword argument 79
  - module 111
  - naming 14, 74, 331
  - nested definition 75
  - nested method definition 331
  - object 389, 551
  - as operator 82
  - parameters 74, 75
  - private 76
  - renaming 391
  - return value 75, 77, 335
  - setter 29, 86
  - vs. variable name 314
  - variable-length arguments 75
- Method class 389, 522, 534
  - == 522
  - [ ] 522
  - arity 522
  - call 389, 522
  - eql? 522
  - to\_proc 523
  - unbind 523
- Method module 630
- method method
  - class Object 522, 551
- method\_added method
  - class Module 392, 536
- method\_defined? method
  - class Module 529
- method\_missing method
  - class Object 551
  - module Kernel 334, 362
- method\_removed method
  - class Module 392, 536
- method\_undefined method
  - class Module 392, 536
- methods method
  - class Object 386, 552
- Meyer, Bertrand 30
- Microsoft Windows 253–260
  - accessing API 254, 734
  - automation 255, 735
  - file associations 254
  - installing Ruby 3, 759
  - message box 259
  - printing under 254
  - running Ruby 254
  - scripting *see* automation (above)
- MIN (Float constant) 466
- min method
  - class Time 625
  - module Enumerable 435
- MIN\_10\_EXP (Float constant) 466
- MIN\_EXP (Float constant) 466
- MINOR\_VERSION (Marshal constant) 515
- Mirroring, using CVSup 5
- MixedCase 14, 313
- Mixin *see* Module
- mkdir method
  - class Dir 430
- mkmf module 755
  - building extensions with 282
  - create\_makefile 282, 757
  - dir\_config 283, 757
  - enable\_config 757
  - find\_library 285, 757
  - have\_func 286, 757
  - have\_header 285, 757
  - have\_library 285, 757
- mkmf library 755
- mktime method
  - class Time 622
- mod\_ruby 234
  - safe level 380
- mode method
  - class File::Stat 458
- Module 110–118
  - constant 111
  - creating extension *see* Extend Ruby
  - defining 339
  - function 340
  - include 112
  - instance variable 115
  - load 112
  - as mixin 111, 340, 366
  - as namespace 110
  - naming 14
  - require 112
  - wrap 380
- Module class 524
  - <, <=, >, >= 525
  - <=> 525
  - === 525
  - alias\_method 533
  - ancestors 365, 386, 526
  - append\_features 533
  - attr 533
  - attr\_accessor 534
  - attr\_reader 534
  - attr\_writer 534
  - autoload 526

- autoload? 526
- class\_eval 526
- class\_variables 527
- clone 527
- const\_defined? 527
- const\_get 527
- const\_missing 527
- const\_set 528
- constants 524, 528
- define\_method 534
- extend\_object 392, 535
- extended 535
- include 340, 535
- include? 528
- included 535
- included\_modules 528
- instance\_method 528, 630
- instance\_methods 529
- method\_added 392, 536
- method\_defined? 529
- method\_removed 392, 536
- method\_undefined 392, 536
- module\_eval 530
- module\_function 340, 537
- name 530
- nesting 524
- new 525
- private 537
- private\_class\_method 33, 530
- private\_instance\_methods 531
- private\_method\_defined? 531
- protected 538
- protected\_instance\_methods 531
- protected\_method\_defined? 531
- public 538
- public\_class\_method 532
- public\_instance\_methods 532
- public\_method\_defined? 532
- remove\_class\_variable 538
- remove\_const 538
- remove\_method 538
- undef\_method 538

- Module module
  - define\_method 345
- module\_eval method
  - class Module 530
- module\_function method
  - class Module 340, 537
- Modules
  - list of methods* 405
  - Abbrev 634, 702
  - Base64 635
  - Benchmark 162, 390, 636
  - BigMath 637
  - Comparable 112, 426
  - Config 173
  - Curses 643
  - Date 621
  - Digest 647
  - DL 648
  - DRbUndumped 649
  - Enumerable 49, 113, 433, 651, 662
  - Enumerator 651
  - ERB::Util 653
  - Errno 104, 439, 440
  - Etc 654
  - Fcntl 488, 656
  - FileTest 462, 693
  - FileUtils 657, 730
  - Find 658
  - Forwardable 659
  - GC 470
  - Kernel 495
  - Marshal 514
  - Math 519
  - Method 630
  - mkmf 755
  - Monitor 674
  - MonitorMixin 136, 674
  - Mutex\_m 133, 676
  - NKF 684
  - ObjectSpace 557
  - Observable 685
  - Open3 485, 687
  - ParseDate 621, 692
  - Process 142, 562, 573
  - Process::GID 568, 573
  - Process::Sys 573
  - Process::UID 573, 575
  - Profiler 696
  - Profiler\_\_ 697
  - PTY 699
  - Readline 702
  - REXML 704
  - Rinda 706

- RSS 707
- Session 699
- Shellwords 711
- Signal 513, 583
- SingleForwardable 659
- Singleton 712
- SOAP 713
- Sync 133
- Timeout 725
- TSort 729
- WEBrick 733
- XMLRPC 736
- Zlib 738
- modulo method
  - class Bignum 421
  - class Fixnum 464
  - class Float 468
  - class Numeric 544
- mon method
  - class Time 625
- Monitor class 134, 136, 717, 722
- Monitor module 674
- monitor library 134
- MonitorMixin module 136, 674
- month method
  - class Time 625
- mswin32 253
- mtime method
  - class File::Stat 459
  - class File 449, 455
- MULTILINE (Regexp constant) 579
- Multiline mode (regexp) 309
- Multiple inheritance 28
  - see also* Module, mixin
- Multithreading *see* Thread
- Music on hold 758
- Mutex class 675, 676
- Mutex\_m module 133, 676
- Mutual exclusion *see* Thread, synchronization
- “My Way” 25

---

## N

- n (Ruby option) 169
- Nagai, Hidetoshi 568
- Nakada, Nobuyoshi 684
- name method
  - class Module 530
- Namespace *see* Module
- Naming conventions 14, 313

- file pathnames 482
- method names 74
- Test::Unit 153
- nan? method
  - class Float 468
- Native thread *see* Thread
- ncurses *see* Curses
- ndbm 645
- Nested assignment 86
- nesting method
  - class Module 524
- net/http library 128
- Net::FTP class 677
- Net::HTTP class 678, 731
- Net::IMAP class 680
- Net::POP3 class 681
- Net::SMTP class 682
- Net::Telnet class 683
- Network protocols
  - DNS 703
  - domain socket 753
  - finger 125
  - ftp 677, 686, 731
    - secure 688
  - generic server for 664
  - HTTP 678, 686, 731
  - HTTPS 688, 731
  - IMAP 680
  - IP 747
  - IP address representation 667
  - IPv4/IPv6 667
  - LDAP 731
  - POP 681
  - server 750, 754
  - SMTP 682
  - socket 125, 714, 741, 743
  - SOCKS 749
  - TCP 748
  - telnet 683
  - UDP 751
- new method
  - see also* Constructor
- new method
  - class Array 406
  - class Class 338, 424, 425
  - class Dir 430
  - class Exception 440
  - class File 120, 449
  - class Hash 471
  - class IO 483
  - class Module 525
  - class Proc 503, 559
  - class Range 577

- class Regexp 579
- class Socket 745
- class SOCKSSocket 749
- class String 585
- class Struct 605, 606
- class TCPServer 750
- class TCPsocket 748
- class ThreadGroup 619
- class Thread 128, 613
- class Time 622
- class UDPSocket 751
- class UNIXServer 754
- class UNIXSocket 753
- Newline (\n) 12, 306
- Newsgroup 759
- next 98, 330, 342
- next method
  - class Integer 480
  - class String 595
- next! method
  - class String 595
- nfk method
  - module NKF 684
- NIL constant 322
- nil constant 14, 87, 321, 326
- nil? method
  - class NilClass 540
  - class Object 552
- NilClass class 540
  - & 540
  - ^ 540
  - | 540
  - nil? 540
  - to\_a 540
  - to\_f 540
  - to\_i 540
  - to\_s 540
- nitems method
  - class Array 415
- NKF module 684
  - nfk 684
- nlink method
  - class File::Stat 459
- No-wait mode I/O 666
- :nodoc: (RDoc) 194
- nonzero? method
  - class Numeric 544
- not (logical not) 88, 326
- Notation xxiv
  - binary, decimal, hex, octal 55, 304
- notify\_observers method
  - module Observable 685
- :notnew: (RDoc) 194

- now method
  - class Time 622
- NTP (Network Time Protocol) 683
- Numbers, unifying 671
- Numeric class 541, 641
  - +@ 541
  - @ 541
  - <=> 541
  - abs 541
  - ceil 541
  - coerce 358, 541
  - div 542
  - divmod 544
  - eql? 544
  - floor 544
  - integer? 544
  - mathn 671
  - modulo 544
  - nonzero? 544
  - quo 545
  - Rational 700
  - remainder 545
  - round 545
  - step 96, 545
  - to\_int 545
  - truncate 545
  - zero? 545

## O

- /o regex option 309
- OBJ\_FREEZE 298
- OBJ\_FROZEN 299
- OBJ\_TAINT 298
- OBJ\_TAINTED 298
- Object 10
  - aliasing 38, 161, 315
  - allocation 273
  - creation 23, 338, 391
  - extending 365, 368
  - finalizer 557
  - freezing 377
  - ID 10, 386
  - immediate 265, 385, 463
  - listing active 385
  - listing methods in 386
  - object\_id 557
  - persistence 698
  - tainting 381
- Object class 27, 376, 546
  - == 546
  - === 546
  - ~= 546

- \_\_id\_\_ 546
  - \_\_send\_\_ 546
  - class 354, 546
  - clone 274, 547
  - display 547
  - dup 274, 547
  - eql? 547
  - equal? 548
  - extend 366, 368, 548
  - freeze 162, 377, 548
  - frozen? 549
  - hash 549
  - id 549
  - initialize 554
  - initialize\_copy 275, 549
  - inspect 549, 694
  - instance\_eval 549
  - instance\_of? 550
  - instance\_variable\_get 550
  - instance\_variable\_set 550
  - instance\_variables 550
  - is\_a? 550
  - kind\_of? 551
  - method 522, 551
  - method\_missing 551
  - methods 386, 552
  - nil? 552
  - object\_id 552
  - private\_methods 552
  - protected\_methods 552
  - public\_methods 553
  - remove\_instance\_variable 555
  - respond\_to? 386, 553
  - send 553
  - singleton\_method\_added 555
  - singleton\_method\_removed 556
  - singleton\_method\_undefined 556
  - singleton\_methods 553
  - taint 554
  - tainted? 554
  - to\_a 554
  - to\_s 24, 554
  - to\_str 266
  - type 354, 554
  - untaint 554
  - see also* Kernel module
  - Object-oriented terminology 9
  - object\_id method
    - class Object 552
  - ObjectSpace module 557
    - \_id2ref 557
    - define\_finalizer 557
    - each\_object 365, 385, 387, 557
    - garbage\_collect 558
    - undefine\_finalizer 558
  - Observable module 685
    - add\_observer 685
    - changed 685
    - changed? 685
    - count\_observers 685
    - delete\_observer 685
    - delete\_observers 685
    - notify\_observers 685
  - Observer pattern 685
  - oct method
    - class String 595
  - Octal notation 55, 304
  - offset method
    - class MatchData 517
  - OLE *see* Microsoft Windows, automation
  - olegen.rb 258
  - once example 374
  - Once option (regexp) 309
  - One-Click Installer 3, 253, 759
  - OO *see* Object-oriented
  - open method
    - class Dir 431
    - class File 51, 120, 450
    - class IO 484
    - class Socket 745
    - class SOCKSSocket 749
    - class TCPServer 750
    - class TCPSocket 748
    - class UDPSocket 751
    - class UNIXServer 754
    - class UNIXSocket 753
    - module Kernel 126, 504, 686
  - open-uri library 126, 686
  - Open3 module 485, 687
  - OpenSSL library 688
  - OPENSSL\_CONF 172
  - OpenStruct class 605, 689
  - Operating system errors 439
  - Operator
    - as method call 82, 335
    - precedence 324
  - Optimizing *see* Performance
  - Option, command line *see* Command line
  - OptionParser class 690
  - options method
    - class Regexp 581
  - or (logical or) 88, 326
  - owned? method
    - class File::Stat 459
    - class File 450
  - Ownership, file *see* File, owner
- 
- ## P
- p (Ruby option) 169, 321
  - p method
    - module Kernel 505
  - \$-p variable 321
  - pack method
    - class Array 123, 414, 415
  - pack\_sockaddr\_in method
    - class Socket 745
  - pack\_sockaddr\_un method
    - class Socket 745
  - Packaging *see* RubyGems
  - pair method
    - class Socket 745
  - Paragraph mode 168
  - Parallel assignment 85, 325
  - Parameter
    - default 74
    - to block 19
  - params method
    - class CGI 224
  - Parent-child 25
  - Parse error 159
  - ParseDate module 621, 692
    - parsedate 622
    - see also* Time class and library
  - parsedate method
    - module ParseDate 622
  - partition method
    - module Enumerable 436
  - pass method
    - class Thread 614
  - PATH 169
  - path method
    - class Dir 431
    - class File 455
    - class UNIXSocket 753
  - Pathname *see* File, pathname
  - Pathname class 693
  - Pattern *see* Regular expression

- Patterns
  - factory 34
  - observer 685
  - singleton 33, 712
- peeraddr method
  - class IPSocket 747
  - class UNIXSocket 753
- Performance 162, 353, 636
  - caching method values 373
  - CGI 234
  - dynamic method invocation 390
  - profiling 163, 696, 697
  - windows automation 258
- Perl/Tk *see* GUI programming
- Perlisms 22, 72, 94
- Permission *see* File, permission
- Persistent object storage 698
- PHP *see* eruby
- PI (Math constant) 519
- pid method
  - class IO 490
  - class Process::Status 571
  - module Process 565
- Pig latin 140, 245
- Pipe *see* IO.pipe, IO.popen
- pipe method
  - class IO 141, 484
- pipe? method
  - class File::Stat 459
  - class File 450
- pop method
  - class Array 416
- popen method
  - class IO 140, 484
- pos method
  - class Dir 431
  - class IO 490
- pos= method
  - class Dir 432
  - class IO 490
- POSIX
  - character classes 67
  - error codes 104
- POSIXLY\_CORRECT 663
- Post Office Protocol (POP) *see* Network protocols, POP
- post method 678
- post\_match method
  - class MatchData 517
- PP class 694
- pp method
  - module Kernel 694
- ppid method
  - module Process 565
- Pragmatic Programmer
  - e-mail address xxii
- Pre-defined variables *see* Variables
- pre\_match method
  - class MatchData 517
- Precedence
  - do...end vs {} 160, 341
  - of operators 324
- Pretty printing 694, 695
- pretty\_print method 694
- PrettyPrint class 505, 694, 695
- Print
  - under Windows 254
- print method
  - class IO 490
  - module Kernel 320, 505
- printf method
  - class IO 491
  - module Kernel 320, 505
- PRIO\_PGRP (Process constant) 562
- PRIO\_PROCESS (Process constant) 562
- PRIO\_USER (Process constant) 562
- priority method
  - class Thread 616
- priority= method
  - class Thread 617
- Private *see* Access control
- private method 36
  - class Module 537
- private\_class\_method method
  - class Module 33, 530
- private\_instance\_methods method
  - class Module 531
- private\_method\_defined? method
  - class Module 531
- private\_methods method
  - class Object 552
- Proc class 53, 76, 342, 344, 357, 523, 534, 559
  - == 559
  - [ ] 559
  - arity 559
  - binding 560
  - call 560
  - new 503, 559
- to\_proc 561
- to\_s 561
- proc method
  - module Kernel 343, 345, 506
  - return from 345
  - and safe level 381
- Process 139–142
  - block 142
  - creating 139, 482, 485, 504, 687
  - exec 500
  - ID (*see also* \$\$) 490
  - priority 564, 566
  - Ruby subprocess 141, 142, 482, 485, 687
  - setting name 320
  - termination 142, 170, 496, 501, 563, 566
  - times 609
- Process module 142, 562, 573
  - abort 562
  - detach 562
  - egid 563
  - egid= 563
  - euid 563
  - euid= 563
  - exit 563
  - exit! 563
  - fork 563
  - getpgid 563
  - getpgrp 563
  - getpriority 564
  - gid 564
  - gid= 564
  - groups 564, 565
  - groups= 564, 565
  - initgroups 564
  - kill 564
  - maxgroups 565
  - maxgroups= 565
  - pid 565
  - ppid 565
  - setpgid 565
  - setpgrp 565
  - setpriority 566
  - setsid 566
  - times 566, 609
  - uid 566
  - uid= 566
  - wait 141, 566
  - wait2 567
  - waitall 566
  - waitpid 567

waitpid2 567  
 Process::GID module 568,  
   573  
 change\_privilege 568  
 eid 568  
 eid= 568  
 grant\_privilege 568  
 re\_exchange 568  
 re\_exchangeable? 568  
 rid 568  
 sid\_available? 568  
 switch 569  
 Process::Status class 142,  
   566, 567, 570  
 & 570  
 == 570  
 >> 570  
 coredump? 570  
 exited? 571  
 exitstatus 571  
 pid 571  
 signaled? 571  
 stopped? 571  
 stopsig 571  
 success? 571  
 termsig 572  
 to\_i 572  
 to\_int 572  
 to\_s 572  
 Process::Sys module 573  
 getegid 573  
 geteuid 573  
 getgid 573  
 getuid 573  
 issetugid 573  
 setegid 573  
 seteuid 573  
 setgid 573  
 setregid 573  
 setresgid 574  
 setresuid 574  
 setreuid 574  
 setrgid 574  
 setruid 574  
 setuid 574  
 Process::UID module 573,  
   575  
 change\_privilege 575  
 eid 575  
 eid= 575  
 grant\_privilege 575  
 re\_exchange 575  
 re\_exchangeable? 575  
 rid 575

sid\_available? 575  
 switch 575  
 profile library 163, 696  
 Profiler 163  
 Profiler module 696  
 Profiler\_\_ module 697  
 Program *see* Process  
 Protected *see* Access control  
 protected method 36  
   class Module 538  
 protected\_instance\_  
   methods  
   method  
   class Module 531  
 protected\_method\_defined?  
   method  
   class Module 531  
 protected\_methods method  
   class Object 552  
 Protocols 356  
 Pseudo terminal 699  
 PStore class 698  
 PTY module 699  
 Public *see* Access control  
 public method 36  
   class Module 538  
 public\_class\_method method  
   class Module 532  
 public\_instance\_methods  
   method  
   class Module 532  
 public\_method\_defined?  
   method  
   class Module 532  
 public\_methods method  
   class Object 553  
 Publish/subscribe 685  
 push method  
   class Array 416  
 puts method  
   class IO 491  
   module Kernel 506  
 puts method  
   class IO 491  
   module Kernel 506  
 pwd method  
   class Dir 431

## Q

qdbm 645  
 Queue class 133, 137, 722  
 quo method  
   class Bignum 421

class Fixnum 464  
 class Numeric 545  
 quote method  
   class Regexp 580  
 Quoting  
   characters in regexp 66, 579  
   URLs and HTML 223

## R

-r (Ruby option) 730  
 -r *Library* (Ruby option)  
   169  
 Race condition 129  
 RADIX (Float constant) 466  
 Radix *see* to\_s methods,  
   Kernel.Integer,  
   String#to\_i  
 Rails, Web framework 240  
 raise method  
   class Thread 617  
   module Kernel 106, 345,  
     506  
 Rake 217  
 Rake (build tool) 204  
 rand method  
   module Kernel 506  
 Range 62  
   as condition 64, 89, 94, 327  
   as interval 64  
   literal 62, 307  
   as sequence 62  
 Range class 63, 307, 576  
   == 577  
   === 577  
   begin 577  
   each 577  
   end 577  
   eql? 578  
   exclude\_end? 578  
   first 578  
   include? 578  
   last 578  
   member? 578  
   new 577  
   step 578  
 Rank, matrix 673  
 rassoc method  
   class Array 416  
 Rational class 671, 700  
 rb\_apply 295  
 rb\_ary\_entry 300  
 rb\_ary\_new 299  
 rb\_ary\_new2 299  
 rb\_ary\_new3 299

- rb\_ary\_new4 299
- rb\_ary\_pop 299
- rb\_ary\_push 299
- rb\_ary\_shift 299
- rb\_ary\_store 299
- rb\_ary\_unshift 300
- rb\_block\_given\_p 297
- rb\_bug 296
- rb\_call\_super 295
- rb\_catch 297
- rb\_create\_new\_instance 295
- rb\_cv\_get 298
- rb\_cv\_set 298
- rb\_cvar\_defined 298
- rb\_cvar\_get 298
- rb\_cvar\_set 298
- rb\_define\_alias 293
- rb\_define\_alloc\_func 293
- rb\_define\_attr 295
- rb\_define\_class 291
- rb\_define\_class\_under 291
- rb\_define\_class\_variable 294
- rb\_define\_const 294
- rb\_define\_global\_const 294
- rb\_define\_global\_function 293
- rb\_define\_hooked\_variable 294
- rb\_define\_method 293
- rb\_define\_module 291
- rb\_define\_module\_function 293
- rb\_define\_module\_under 292
- rb\_define\_readonly\_variable 294
- rb\_define\_singleton\_method 293
- rb\_define\_variable 294
- rb\_define\_virtual\_variable 294
- rb\_each 297
- rb\_ensure 296
- rb\_exit 296
- rb\_extend\_object 292
- rb\_fatal 296
- rb\_funcall 295
- rb\_funcall2 295
- rb\_funcall3 295
- rb\_global\_variable 295
- rb\_gv\_get 298
- rb\_gv\_set 298
- rb\_hash\_aref 300
- rb\_hash\_aset 300
- rb\_hash\_new 300
- rb\_id2name 295
- rb\_include\_module 292
- rb\_intern 295
- rb\_iter\_break 297
- rb\_iterate 297
- rb\_iv\_get 297
- rb\_iv\_set 298
- rb\_ivar\_get 298
- rb\_ivar\_set 298
- rb\_load\_file 290
- rb\_notimplement 296
- rb\_obj\_is\_instance\_of 300
- rb\_obj\_is\_kind\_of 300
- rb\_protect 296
- rb\_raise 296
- rb\_require 292
- rb\_rescue 296
- rb\_respond\_to 300
- rb\_safe\_level 299
- rb\_scan\_args 293
- rb\_secure 299
- rb\_set\_safe\_level 299
- rb\_str\_cat 300
- rb\_str\_concat 300
- rb\_str\_dup 300
- rb\_str\_new 300
- rb\_str\_new2 300
- rb\_str\_split 300
- rb\_struct\_aref 292
- rb\_struct\_aset 292
- rb\_struct\_define 292
- rb\_struct\_new 292
- rb\_sys\_fail 296
- rb\_thread\_create 300
- rb\_throw 297
- rb\_undef\_method 293
- rb\_warn 297
- rb\_warning 297
- rb\_yield 297
- rbconfig.rb 173
- rbconfig.rb *see* Config module
- rdev method
  - class File::Stat 459
- rdev\_major method
  - class File::Stat 459
- rdev\_minor method
  - class File::Stat 459
- RDoc 7, 187–200
  - C extensions 195
  - :call-seq: 194, 197
  - comment format 187–193
  - :doc: 194
  - Document-class: 197
  - Document-method: 197
  - documentation modifiers 193
  - embedding in Ruby 187
  - :enddoc: 195
  - heading 193
  - hyperlink 192
  - :include: 194
  - lists 192
  - :main: 195
  - :nodoc: 194
  - :notnew: 194
  - including README 199
  - generate ri documentation 200
  - for RubyGems 207
  - rules 193
  - running 199
  - :startdoc: 195
  - :stopdoc: 195
  - templates 227
  - :title: 195
  - yield parameters 193
  - :yields: 194
- RDoc::usage method 201
- RDoc::usage\_no\_exit method 201
- rdtool 303
- re\_exchange method
  - module Process::GID 568
  - module Process::UID 575
- re\_exchangeable? method
  - module Process::GID 568
  - module Process::UID 575
- read method
  - class Dir 432
  - class IO 485, 491
- readable? method
  - class File::Stat 459
  - class File 450
- readable\_real? method
  - class File::Stat 460
  - class File 450
- readbytes library 701
- readbytes method
  - class IO 701
- readchar method

- class IO 491
- Readline module 702
- readline library 155, 176, 182
- readline method
  - class IO 491
  - module Kernel 320, 506
- readlines method
  - class IO 485, 492
  - module Kernel 507
- readlink method
  - class File 450
- README 199
- ready? method
  - class IO 666
- REALLOC\_N 280
- Really Simple Syndication 707
- Receiver 11, 76, 334, 362
- Record separator *see* \$/
- recv method
  - class BasicSocket 742
- recvfrom method
  - class IPSocket 747
  - class Socket 746
  - class UDPSocket 752
  - class UNIXSocket 753
- redo 98, 330
- Reference
  - to object 37
  - weak 732
- Reflection 384–395
  - callbacks 392
- Regexp class 72, 579
  - == 580
  - === 580
  - =~ 580
  - ~ 580
  - casefold? 581
  - compile 579
  - escape 579
  - inspect 581
  - kcode 581
  - last\_match 579
  - match 65, 73, 581
  - new 579
  - options 581
  - quote 580
  - source 581
  - to\_s 582
- Regular expression 64–73, 309–313
  - alternation 69
  - anchor 66
  - character class 67
  - as condition 327
  - extensions 311
  - greedy 69
  - grouping 69
  - literal 64, 309
  - nested 312
  - object-oriented 72
  - options 309, 312, 579
  - pattern match variables 319
  - quoting within 66
  - repetition 68
  - substitution 70, 593
- rehash method
  - class Hash 308, 477
- reject method
  - class Hash 477
  - module Enumerable 416, 436
- reject! method
  - class Array 416
  - class Hash 477
- remainder method
  - class Bignum 422
  - class Numeric 545
- Remote Procedure Call *see*
  - Distributed Ruby, SOAP,
  - XMLRPC
- remove\_class\_variable
  - method
    - class Module 538
- remove\_const method
  - class Module 538
- remove\_instance\_variable
  - method
    - class Object 555
- remove\_method method
  - class Module 538
- rename method
  - class File 451
- reopen method
  - class IO 357, 492
- replace method
  - class Array 416
  - class Hash 357, 477
  - class String 595
- require method 112, 117
  - loading extensions 264
  - module Kernel 172, 320, 507, 526
- require\_gem 208
- rescue 102, 346, 439
- Reserved words 314
- resolv library 703
- resolv-replace library 703
- respond\_to? method
  - class Object 386, 553
- restore method
  - module Marshal 515
- retry
  - in exceptions 106, 107, 347
  - in loops 99, 330
- return
  - from block 344
  - from lambda/proc 345
  - from Proc 344
  - see also* Method, return value
- reverse method
  - class Array 416
  - class String 595
- reverse! method
  - class Array 416
  - class String 595
- reverse\_each method
  - class Array 417
- rewind method
  - class Dir 432
  - class IO 492
- REXML module 704
- RFC 2045 (base 64) 635
- RFC 2396 (URI) 731
- RFC 2616 (HTTP) 724
- RFC 2882 (e-mail) 724
- .rhtml (eruby) 230
- RI 8, 202
- ri 7, 187–200
  - add to irb 180
  - directories 200
  - sample output 191
  - see also* RDoc
- Rich Site Summary 707
- rid method
  - module Process::GID 568
  - module Process::UID 575
- Rinda module 706
- rinda *see* Distributed Ruby
- rindex method
  - class Array 417
  - class String 595
- RIPMD-160 hash 647
- rjust method
  - class String 596
- rmdir method
  - class Dir 431
- RMI *see* Distributed Ruby
- Roll, log files 669
- Roman numerals 143
  - example 356
- round method



- class Float 468
  - class Integer 480
  - class Numeric 545
  - ROUNDS (Float constant) 466
  - RPM installation 2
  - RSS module 707
  - RSTRING macro 266
  - rstrip method
    - class String 596
  - rstrip! method
    - class String 596
  - rtags 185
  - Ruby
    - debugger 155
    - distributed 398–399
    - download 759
    - embed in application 287
    - installing 2, 284
    - language reference 302–348
    - and Perl 22, 72, 94
    - versions xx
    - Web sites xxii, 758
    - ports to Windows 253
  - ruby (mkmf) 756
  - Ruby Documentation Project 8, 759
  - Ruby mode (emacs) 157
  - Ruby On Rails 240
  - Ruby Production Archive (RPA) 759
  - ruby-doc.org 8
  - ruby-mode.el 157
  - ruby.exe and rubyw.exe 254
  - ruby\_finalize 290
  - ruby\_init 290
  - ruby\_init\_loadpath 290
  - ruby\_options 290
  - ruby\_run 290
  - ruby\_script 290
  - RUBY\_TCL\_DLL 172
  - RUBY\_TK\_DLL 172
  - RUBY\_PLATFORM constant 322
  - RUBY\_PLATFORM variable 216
  - RUBY\_RELEASE\_DATE constant 322
  - RUBY\_VERSION constant 322
  - RubyForge 217, 759
  - RubyGarden 759
  - RubyGems 203–221
    - creating 211
    - documentation 207
    - extensions 215
    - gem\_server 208
    - gemspec 212–214
    - installing applications 204
    - installing library 206
    - installing RubyGems 204
    - package layout 211
    - repository 759
    - require\_gem 208
    - stub 210
    - test on install 205
    - versioning 205, 206f, 209
  - RUBYLIB 172, 173, 383
  - RUBYLIB\_PREFIX 172
  - RUBYOPT 172, 383
  - RUBYPATH 169, 172
  - RUBYSHELL 172, 500
  - Rule, RDoc 193
  - run method
    - class Thread 617
  - Runtime Type Information (RTTI) *see* Reflection
  - Rvalue 84, 323
- ## S
- 
- S (Ruby option) 169
  - s (Ruby option) 169
  - SAFE variable 169, 299, 321, 380, 554, 652
  - Safe level 379–382
    - in extensions 298
    - list of constraints 383f
    - and proc 381
    - setting using -T 169
    - and tainting 381
  - safe\_level method
    - class Thread 618
  - SafeStringValue 299
  - SafeStringValue method 267
  - Sandbox 380, 381, *see* Safe level
    - chroot 429
  - scan method
    - class String 60, 61, 311, 596, 716
    - module Kernel 507
  - scanf library 708
  - scanf method
    - class Array 708
    - class String 708
    - module Kernel 708
  - Scheduler, thread 132
  - Schneiker, Conrad 78n
  - Schwartz, Randal 437
  - Schwartzian transform 437
  - Scope of variables 99, 315
  - Screen output *see* Curses
  - SCRIPT\_LINES\_\_ constant 322, 395, 507
  - SDBM class 709
  - sdbm 709
  - Search path 173, 284
  - sec method
    - class Time 626
  - seek method
    - class Dir 432
    - class IO 492
  - Seki, Masatoshi 398
  - select method
    - class Hash 478
    - class IO 357, 486
    - class MatchData 517
    - module Enumerable 436
    - module Kernel 507
  - self variable 76, 115, 322, 334, 362
    - in class definition 370
  - Semaphore *see* Thread, synchronization
  - Send message 10, 26
  - send method
    - class BasicSocket 742
    - class Object 553
    - class UDPSocket 752
  - Sequence *see* Range
  - Serialization *see* Marshal
  - Server 664
  - Session *see* CGI programming, session
  - Session module 699
  - Session leader 566
  - Session, HTTP 233
  - Set class 407, 409, 710
  - Set operations *see* Array class
  - set\_backtrace method
    - class Exception 441
  - set\_trace\_func method
    - module Kernel 393, 423, 508, 728
  - setgid method
    - module Process::Sys 573
  - seteuid method
    - module Process::Sys 573
  - setgid, setuid 380
  - setgid method
    - module Process::Sys 573
  - setgid? method
    - class File::Stat 460
    - class File 451
  - setpgid method

- module Process 565
- setpgrp method
  - module Process 565
- setpriority method
  - module Process 566
- setregid method
  - module Process::Sys 573
- setresgid method
  - module Process::Sys 574
- setresuid method
  - module Process::Sys 574
- setreuid method
  - module Process::Sys 574
- setrgid method
  - module Process::Sys 574
- setruuid method
  - module Process::Sys 574
- setsid method
  - module Process 566
- setsockopt method
  - class BasicSocket 742
- Setter method *see* Method, setter
- setuid method
  - module Process::Sys 574
- setuid? method
  - class File::Stat 460
  - class File 451
- setup method 150
- SHA1/2 hash 647
- Shallow copy 547
- Shared library, accessing 648
- Shebang (!) 6
- SHELL 172
- Shell glob *see* File, expanding names
- Shellwords module 711
- shift method
  - class Array 417
  - class Hash 478
- shutdown method
  - class BasicSocket 742
- sid\_available? method
  - module Process::GID 568
  - module Process::UID 575
- SIGALRM 508
- SIGCLD 142
- Signal
  - handling 142
  - sending 564
  - see also* trap method
- Signal module 513, 583
  - list 583
  - trap 584
- signaled? method
  - class Process::Status 571
- Simple Mail Transfer Protocol
  - see* Network protocols, SMTP
- Simple Object Access protocol
  - see* SOAP
- SimpleDelegator class 646
- sin method
  - module Math 520
- Sinatra, Frank 25
- Single inheritance 28
- Single-quoted string 57, 305
- SingleForwardable module 659
- Singleton module 712
- Singleton class 365
- Singleton pattern 33, 712
- singleton\_method\_added method
  - class Object 555
  - module Kernel 392
- singleton\_method\_removed method
  - class Object 556
  - module Kernel 392
- singleton\_method\_undefined method
  - class Object 556
- singleton\_method\_undefined method
  - module Kernel 392
- singleton\_methods method
  - class Object 553
- sinh method
  - module Math 521
- site\_ruby directory 173
- size method
  - class Array 417
  - class Bignum 422
  - class File::Stat 460
  - class File 451
  - class Fixnum 465
  - class Hash 478
  - class MatchData 517
  - class String 597
  - class Struct 608
- size? method
  - class File::Stat 460
  - class File 451
- SizedQueue class 722
- SJIS 302, 309, 668
- sleep method
  - module Kernel 508
- slice method
  - class Array 417
  - class String 597
- slice! method
  - class Array 418
  - class String 597
- Smalltalk 10n, 365
- SMTP *see* Network protocols, SMTP
- SOAP 236, 399, 713
- SOAP module 713
- Socket *see* Network protocols
- Socket class 714, 743
  - accept 746
  - bind 746
  - connect 746
  - getaddrinfo 744
  - gethostbyaddr 744
  - gethostbyname 744
  - gethostname 744
  - getnameinfo 745
  - getservbyname 745
  - listen 746
  - new 745
  - open 745
  - pack\_sockaddr\_in 745
  - pack\_sockaddr\_un 745
  - pair 745
  - recvfrom 746
  - socketpair 745
  - sysaccept 746
  - unpack\_sockaddr\_in 746
  - unpack\_sockaddr\_un 746
- socket? method
  - class File::Stat 460
  - class File 452
- socketpair method
  - class Socket 745
- SOCKS *see* Network protocols
- SOCKSSocket class 714, 749
  - close 749
  - new 749
  - open 749
- Sort
  - topological 729
- sort method
  - class Array 418
  - class Hash 478
  - module Enumerable 436
  - Schwartzian transform 437
- sort! method

- class Array 418
- sort\_by method
  - module Enumerable 436
- Source code
  - layout 302
  - reflecting on 394
- Source code from book 4
- source method
  - class Regexp 581
- Spaceship *see* <=>
- Spawn *see* Process, creating
- spawn method 699
- split method
  - class File 452
  - class String 59, 598
  - module Kernel 168, 508
- sprintf method
  - field types 511
  - flag characters 510
  - module Kernel 508
- sqrt method
  - module Math 521
- squeeze method
  - class String 60, 598, 668
- squeeze! method
  - class String 599, 668
- srand method
  - module Kernel 509
- srcdir (mkmf) 756
- Stack
  - execution *see* caller
  - method
  - operations *see* Array class
  - unwinding 104, 108, 346
- Stack frame 155
- Standard Library 632–738
- start method
  - class Thread 614
  - module GC 470
- :startdoc: (RDoc) 195
- stat method
  - class File 452
  - class IO 492
- Statement modifier
  - if/unless 91, 328
  - while/until 94, 330
- Static linking 287
- Static method *see* Class, method
- Static typing *see* Duck typing
- status method 686
  - class Exception 441
  - class Thread 618
- STDERR constant 322, 513
- \$stderr variable 320
- STDIN constant 322, 504
- \$stdin variable 320
- STDOUT constant 322, 504, 505
- \$stdout variable 320
- step method
  - class Numeric 96, 545
  - class Range 578
- Stephenson, Neal 167n
- sticky? method
  - class File::Stat 460
  - class File 452
- stiff, why the lucky 633
- stop method
  - class Thread 614
- stop? method
  - class Thread 618
- :stopdoc: (RDoc) 195
- stopped? method
  - class Process::Status 571
- stopsig method
  - class Process::Status 571
- store method
  - class Hash 478
- strftime method
  - class Time 626
- String 57
  - #{...} 57
  - %... delimiters 303
  - control characters \n etc. 306
  - conversion for output 123, 505
  - expression interpolation 13
  - here document 58, 306
  - literal 12, 57, 305
    - concatenation 306
- String class 57, 305, 358, 585, 668, 708
  - % 585
  - \* 586
  - + 586
  - <=> 586
  - << 586
  - == 586
  - === 586
  - ~= 587
  - [ ] 587
  - [ ]= 588
  - ~ 588
  - capitalize 588
  - capitalize! 588
  - casecmp 589
- center 589
- chomp 59, 589
- chomp! 589
- chop 589, 668
- chop! 590, 668
- concat 590
- count 590
- crypt 590
- delete 590, 668
- delete! 591, 668
- downcase 591
- downcase! 591
- dump 591
- each 591
- each\_byte 592
- each\_line 592
- empty? 592
- eql? 592
- gsub 70, 311, 592
- gsub! 311, 593
- hex 593
- include? 593
- index 311, 593
- insert 594
- intern 594
- length 594
- ljust 594
- lstrip 594
- lstrip! 594
- match 595
- new 585
- next 595
- next! 595
- oct 595
- replace 595
- reverse 595
- reverse! 595
- rindex 595
- rjust 596
- rstrip 596
- rstrip! 596
- scan 60, 61, 311, 596, 716
- scanf 708
- size 597
- slice 597
- slice! 597
- split 59, 598
- squeeze 60, 598, 668
- squeeze! 599, 668
- strip 599
- strip! 599
- sub 70, 599
- sub! 599
- succ 599, 668

- succ! 600, 668
- sum 600
- swapcase 600
- swapcase! 600
- to\_f 600
- to\_i 601
- to\_s 601
- to\_str 601
- to\_sym 601
- tr 601, 668
- tr! 602, 668
- tr\_s 602, 668
- tr\_s! 602, 668
- unpack 602
- upcase 602
- upcase! 604
- upto 604
- String method
  - module Kernel 495
- string method
  - class MatchData 518
- StringIO class 124, 715
- StringScanner class 716
- StringValue method 266
- StringValuePtr method 267
- strip method
  - class String 599
- strip! method
  - class String 599
- Struct class 605
  - == 606
  - [ ] 606, 607
  - [ ]= 607
  - each 607
  - each\_pair 607
  - length 608
  - members 606, 608
  - new 605, 606
  - OpenStruct 689
  - size 608
  - to\_a 608
  - values 608
  - values\_at 608
- struct sockaddr 741
- Struct::Tms class 609
- Stub
  - RubyGems 210
  - WIN32OLE 258
- sub method
  - class String 70, 599
  - module Kernel 509
- sub! method
  - class String 599
  - module Kernel 509

- Subclass 25
- Subnet, testing address in 667
- Subprocess *see* Process
- Subroutine *see* Method
- Substitution *see* Regular expression
- succ method
  - class Integer 481
  - class String 599, 668
  - for generating sequences 63
- succ! method
  - class String 600, 668
- success? method
  - class Exception 442
  - class Process::Status 571
- Suites, test 152
- Suketa, Masaki 255
- sum method
  - class String 600
- super 27, 335, 554
- Superclass 25, 362, 386
  - see also* Module, mixin
- superclass method
  - class Class 386, 425
- swapcase method
  - class String 600
- swapcase! method
  - class String 600
- SWIG 287
- switch method
  - module Process::GID 569
  - module Process::UID 575
- Symbol
  - literal 308
- Symbol class 29, 323, 358, 594, 610
  - all\_symbols 610
  - id2name 610
  - inspect 611
  - to\_i 611
  - to\_int 611
  - to\_s 611
  - to\_sym 611
- symlink method
  - class File 452
- symlink? method
  - class File::Stat 461
  - class File 452
- Sync class 717
- Sync module 133
- sync method
  - class IO 493
- sync= method
  - class IO 493

- SyncEnumerator class 662
- Synchronization *see* Thread, synchronization
- sysaccept method
  - class Socket 746
- syscall.h 509
- syscall method
  - module Kernel 509
- Syslog class 719
- sysopen method
  - class IO 486
- sysread method
  - class IO 493
- sysseek method
  - class IO 493
- system method
  - module Kernel 140, 509
- syswrite method
  - class IO 493

## T

---

- T[*level*] (Ruby option) 169
- Tab completion
  - irb 176
- Tag file 185
- taint method
  - class Object 554
- Tainted objects 267, 381, 554
  - see also* Safe level
- tainted? method
  - class Object 554
- Talbott, Nathaniel 143, 153
- tan method
  - module Math 521
- tanh method
  - module Math 521
- Tcl/Tk *see* GUI programming
- TCP *see* Network protocols
- TCPServer class 750
  - accept 750
  - new 750
  - open 750
- TCPsocket class 714, 748
  - gethostname 748
  - new 748
  - open 748
- teardown method 150
- Technical support 758
- tell method
  - class Dir 432
  - class IO 494
- Telnet *see* Network protocols, telnet
- Tempfile class 720

- Templates 226–231
    - Amrita 228
    - BlueCloth 206
    - eruby 229, 652
    - RDoc 227
  - Temporary directory 727
  - Temporary file 720
  - Terminal
    - pseudo 699
  - terminate method
    - class Thread 618
  - termsig method
    - class Process::Status 572
  - Ternary operator 91, 328
  - Test case 148
  - Test suites 152
  - test method
    - module Kernel 510
  - Test::Unit 144–153
    - exceptions 147
    - assertions 144, 154f
    - cases 148
    - naming conventions 153
    - setup 150
    - suites 152
    - teardown 150
    - see also* Testing
  - Test::Unit class 721
  - Testing 143–153
    - ad hoc 143
    - assertions 144
    - exceptions 147
    - gem 205
    - Roman numerals 143
    - using StringIO 715
    - structuring tests 148
    - what is a unit test? 144
    - where to put files 151
  - \$' variable 65, 319, 517
  - then 328
  - Thread 127–139
    - condition variable 137
    - creating 127
    - exception 130
    - group 619
    - queue 722
    - race condition 129
    - scheduling 132
    - synchronization 133–139, 674–676, 717, 722
    - variable 129
    - variable scope 128
    - waiting for multiple 723
  - Thread class 612
    - [ ] 614
    - [ ]= 615
    - abort\_on\_exception 130, 612, 615
    - abort\_on\_exception= 612, 615
    - alive? 615
    - critical 612
    - critical= 133, 612
    - current 613
    - exit 613, 615
    - fork 613
    - group 615
    - join 129, 615
    - key? 616
    - keys 616
    - kill 613, 616
    - list 613
    - main 613
    - new 128, 613
    - pass 614
    - priority 616
    - priority= 617
    - Queue 722
    - raise 617
    - run 617
    - safe\_level 618
    - SizedQueue 722
    - start 614
    - status 618
    - stop 614
    - stop? 618
    - terminate 618
    - value 129, 618
    - wakeup 618
  - thread library 133, 137
  - ThreadGroup class 615, 619
    - add 619
    - enclose 619
    - enclosed? 620
    - freeze 620
    - list 620
    - new 619
  - ThreadsWait class 723
  - throw method
    - module Kernel 108, 347, 510
  - Time class 444, 621, 724
    - + 623
    - 623
    - <=> 623
    - asctime 623
    - at 621
  - ctime 623
  - day 623
  - dst? 623
  - extensions to 724
  - getgm 624
  - getlocal 624
  - getutc 624
  - gm 621
  - gmt? 624
  - gmt\_offset 624
  - gmtime 624
  - gmtoff 625
  - hour 625
  - isdst 625
  - local 622
  - localtime 625
  - mday 625
  - min 625
  - mktime 622
  - mon 625
  - month 625
  - new 622
  - now 622
  - sec 626
  - strftime 626
  - times 622
  - to\_a 626
  - to\_f 626
  - to\_i 626
  - to\_s 626
  - tv\_sec 627
  - tv\_usec 627
  - usec 627
  - utc 622, 628
  - utc? 628
  - utc\_offset 628
  - wday 628
  - yday 628
  - year 628
  - zone 628
- time library 724
  - Timeout module 725
  - times method
    - class Integer 96, 481
    - class Time 622
    - module Process 566, 609
  - :title: (RDoc) 195
  - Tk *see* GUI programming
  - Tk class 726
  - tmpdir library 720, 727
  - tmpdir method
    - class Dir 233, 727
  - to\_a method
    - class Array 418

- class Hash 478
  - class MatchData 518
  - class NilClass 540
  - class Object 554
  - class Struct 608
  - class Time 626
  - module Enumerable 438
  - to\_ary method 325, 357, 408, 418
    - class Array 418
  - to\_enum method 651
  - to\_f method
    - class Bignum 422
    - class Fixnum 465
    - class Float 468
    - class NilClass 540
    - class String 600
    - class Time 626
  - to\_hash method 357, 472
    - class Hash 478
  - to\_i method
    - class Float 468
    - class Integer 481
    - class IO 494
    - class NilClass 540
    - class Process::Status 572
    - class String 601
    - class Symbol 611
    - class Time 626
  - to\_int method 356, 357
    - class Float 468
    - class Integer 481
    - class Numeric 545
    - class Process::Status 572
    - class Symbol 611
  - to\_io method 357
    - class IO 494
  - to\_proc method 357
    - class Method 523
    - class Proc 561
  - to\_s method 356
    - class Array 419
    - class Bignum 422
    - class Exception 442
    - class Fixnum 465
    - class Float 469
    - class Hash 478
    - class MatchData 518
    - class NilClass 540
    - class Object 24, 554
    - class Process::Status 572
    - class Proc 561
    - class Regexp 582
    - class String 601
    - class Symbol 611
    - class Time 626
    - and print 123, 505
  - to\_str method 356, 358, 585
    - class Exception 442
    - class Object 266
    - class String 601
  - to\_sym method 358
    - class Fixnum 465
    - class String 601
    - class Symbol 611
  - to\_yaml\_properties method 397
  - Top-level environment 376
  - TOPLEVEL\_BINDING constant 322
  - Topological sort 729
  - tr method
    - class String 601, 668
  - tr! method
    - class String 602, 668
  - tr\_s method
    - class String 602, 668
  - tr\_s! method
    - class String 602, 668
  - trace\_var method
    - module Kernel 511
  - tracer library 728
  - Tracing 393, *see* Logger
  - Transactions 50
  - Transcendental functions 519
  - Transparent language 50, 55
  - transpose method
    - class Array 419
  - trap method
    - module Kernel 142, 513
    - module Signal 584
  - Trigonometric functions 519
  - Troubleshooting 159
  - TRUE constant 322
  - true constant 87, 322, 326
  - TrueClass class 629
    - & 629
    - ^ 629
    - | 629
  - truncate method
    - class File 452, 455
    - class Float 469
    - class Integer 481
    - class Numeric 545
  - TSort module 729
  - tsort\_each\_child method 729
  - tsort\_each\_node method 729
  - tty? method
    - class IO 494
  - Tuning *see* Performance
  - Tuplespace *see* Distributed Ruby, Rinda
  - tv\_sec method
    - class Time 627
  - tv\_usec method
    - class Time 627
  - type method
    - class Object 354, 554
  - Types *see* Duck typing
  - Typographic conventions xxiv
- ## U
- 
- UDP *see* Network protocols
  - UDPSocket class 714, 751
    - bind 751
    - connect 751
    - new 751
    - open 751
    - recvfrom 752
    - send 752
  - uid method
    - class File::Stat 461
    - module Process 566
  - uid= method
    - module Process 566
  - umask method
    - class File 453
  - un library 730
  - Unary minus, unary plus 541
  - unbind method
    - class Method 523
  - UnboundMethod class 389, 522, 523, 528, 630
    - arity 631
    - bind 631
  - undef\_method method
    - class Module 538
  - undefine\_finalizer method
    - module ObjectSpace 558
  - ungetc method
    - class IO 494
  - Unicode 302
  - Uniform Access Principle* 30
  - uniq method
    - class Array 419
  - uniq! method
    - class Array 419
  - Unit test *see* Testing
  - UNIXServer class 754
    - accept 754

- new 754
- open 754
- UNIXSocket class 714, 753
  - addr 753
    - new 753
    - open 753
    - path 753
    - peeraddr 753
    - recvfrom 753
- unless *see* if expression
- unlink method
  - class Dir 431
  - class File 453
- unpack method
  - class String 602
- unpack\_sockaddr\_in method
  - class Socket 746
- unpack\_sockaddr\_un method
  - class Socket 746
- unshift method
  - class Array 419
- untaint method
  - class Object 554
- until *see* while loop
- untrace\_var method
  - module Kernel 513
- uppercase method
  - class String 602
- uppercase! method
  - class String 604
- update
  - Observable callback 685
- update method
  - class Hash 479
- upto method
  - class Integer 96, 481
  - class String 604
- URI class 731
- URI, opening as file 686
- Usage, message 201
- usec method
  - class Time 627
- Usenet 759
- UTC 621
- utc method
  - class Time 622, 628
- utc? method
  - class Time 628
- utc\_offset method
  - class Time 628
- UTF 302
- UTF8 309, 668
- utime method
  - class File 453

## V

- v (Ruby option) 514
- v, --verbose (Ruby option) 169, 321
- \$-v variable 321
- VALUE (C extension) 264
- value method
  - class Thread 129, 618
- value? method
  - class Hash 479
- values method
  - class Hash 479
  - class Struct 608
- values\_at method
  - class Array 419
  - class Hash 479
  - class MatchData 518
  - class Struct 608
- Variable
  - class 31
  - in extension 294, 297
  - instance 10, 24, 115, 387
  - vs. method name 314
  - naming 14, 313
  - predefined 318
  - as reference 37, 315
  - scope 99, 117, 128, 315
  - thread 129
  - weak reference 732
- Variable-length argument list 75
- Variables
  - #! 102, 319, 345, 347
  - \$" 117, 320
  - \$\$ 320
  - && 65, 319, 516
  - \* 320, 502
  - +\$ 319
  - \$\_ 319, 415, 505
  - \$\_0 319
  - \$\_F 320
  - \$\_I 321
  - \$\_K 321
  - \$\_a 320
  - \$\_d 321
  - \$\_i 321
  - \$\_l 321
  - \$\_p 321
  - \$\_v 321
  - \$\_w 321
  - \$. 319, 489
  - \$/ 168, 169, 319, 589
  - \$0 170, 320, 322
- \$1 to \$9 319
- \$1...\$9 65, 70, 311
- \$: 117, 152, 168, 173, 290, 320
- \$; 168, 319
- \$< 320
- \$= 309, 319
- \$> 320
- \$? 83, 140, 142, 320, 323, 495, 510, 566, 570
- \$@ 319
- \$DEBUG 168, 321, 612, 616
- \$F 168, 321
- \$FILENAME 321
- \$KCODE 309, 638, 668
- \$LOAD\_PATH 152, 168, 175, 209–211, 213, 216, 321
- \$\$SAFE 169, 299, 321, 380, 554, 652
- \$VERBOSE 168, 169, 321, 513
- \$\ 169, 319, 490, 505
- \$\_ 22, 89, 95, 168, 320, 327, 489, 502
- \$` 65, 319, 517
- \$configure\_args 755
- \$deferr 320
- \$defout 320
- \$expect\_verbose 655
- \$stderr 320
- \$stdin 320
- \$stdout 320
- \$' 65, 319, 517
- \$~ 65, 73, 319, 516, 579–581
- @fileutils\_output 657
- \_\_FILE\_\_ 394
- ARGF 22, 321
- ARGV 168–170, 321, 502, 663, 690
- ENV 171, 321
- environment *see* Environment variables
- \_\_FILE\_\_ 321
- \_\_LINE\_\_ 321
- predefined 318
  - English names 318, 650
- RUBY\_PLATFORM 216
- self 76, 115, 322, 334, 362
- Vector class 673
- \$VERBOSE variable 168, 169, 321, 513
- version (Ruby option) 169
- Versions of Ruby xx

vi and vim 157  
 tag file 185  
 vi key binding 702  
 Virtual  
 class 364  
 Virtual attribute 30

## W

-w (Ruby option) 169, 321, 514  
 -W *level* (Ruby option) 169, 513  
 \$-w variable 321  
 wait method  
 class IO 666  
 module Process 141, 566  
 wait2 method  
 module Process 567  
 waitall method  
 module Process 566  
 waitpid method  
 module Process 567  
 waitpid2 method  
 module Process 567  
 wakeup method  
 class Thread 618  
 Walk directory tree 658  
 warn method  
 module Kernel 169, 321, 513  
 Warnings 169  
 ARGV[0] is not \$0 170  
 be careful with tainted data 379  
 C functions must return VALUE 263  
 strings aren't numbers 56, 161  
 wday method  
 class Time 628  
 Weak reference 732  
 WeakRef class 732  
 weakref\_alive? 732  
 weakref\_alive? method  
 class WeakRef 732  
 Web *see* CGI programming  
 Web framework

CGIKit 240  
 Iowa 226  
 Rails 240  
 Web server  
 trivial 750  
 WEBrick 234, 733  
*see also* Apache  
 Web services 236  
 description language 239  
 Google 238  
 Web sites for Ruby xxii, 758  
 Webcoder, Walter 379  
 WEBrick 234  
 WEBrick module 733  
 Weirich, Jim 204  
 when (in case) 328  
 while loop 94, 329  
 as modifier 94, 330  
 why the lucky stiff 633  
 Widget *see* GUI programming  
 Wildcard *see* fnmatch and glob  
 Win32API class 648, 734  
 Win32API library 254  
 WIN32OLE class 735  
 WIN32OLE library 255  
 Windows *see* Microsoft  
 Windows, GUI programming  
 with-cflags (mkmf) 756  
 with-cppflags (mkmf) 756  
 with-ldflags (mkmf) 756  
 with-make-prog (mkmf) 756  
 WNOHANG (Process constant) 562  
 Words  
 array of 14, 307  
 Working directory 168, 429  
 Wrap *see* Module, wrap  
 writable? method  
 class File::Stat 461  
 class File 453  
 writable\_real? method  
 class File::Stat 461  
 class File 453  
 write method

class IO 494  
 WSDL 239, 713  
 Google interface 239  
 WUNTRACED (Process constant) 562  
 Wyss, Clemens 380

## X

/x regexp option 309  
 -x [*directory*] (Ruby option) 170  
 -X *directory* (Ruby option) 170  
 XML 704, 736  
 XMLRPC module 736  
 xmp 186

## Y

-y, --yydebug (Ruby option) 170  
 YAML library 397, 514, 633, 737  
 yday method  
 class Time 628  
 year method  
 class Time 628  
 yield 47, 342  
 arguments 19, 48  
 and RDoc 193  
 :yields: (RDoc) 194  
 Yukihiro, Matsumoto 365

## Z

zero? method  
 class File::Stat 461  
 class File 453  
 class Fixnum 465  
 class Float 469  
 class Numeric 545  
 Zip compression 738  
 zip method  
 module Enumerable 438  
 Zlib module 738  
 zone method  
 class Time 628



## Template characters for Array#pack

Directive	Meaning
@	Moves to absolute position
A	ASCII string (space padded, count is width)
a	ASCII string (null padded, count is width)
B	Bit string (descending bit order)
b	Bit string (ascending bit order)
C	Unsigned char
c	Char
D, d	Double-precision float, native format
E	Double-precision float, little-endian byte order
e	Single-precision float, little-endian byte order
F, f	Single-precision float, native format
G	Double-precision float, network (big-endian) byte order
g	Single-precision float, network (big-endian) byte order
H	Hex string (high nibble first)
h	Hex string (low nibble first)
I	Unsigned integer
i	Integer
L	Unsigned long
l	Long
M	Quoted printable, MIME encoding (see RFC2045)
m	Base64 encoded string
N	Long, network (big-endian) byte order
n	Short, network (big-endian) byte order
P	Pointer to a structure (fixed-length string)
p	Pointer to a null-terminated string
<u>1.8</u> Q, q	64-bit number
S	Unsigned short
s	Short
U	UTF-8
u	UU-encoded string
V	Long, little-endian byte order
v	Short, little-endian byte order
<u>1.8</u> w	BER-compressed integer <sup>1</sup>
X	Back up a byte
x	Null byte
Z	Same as A

<sup>1</sup> The octets of a BER-compressed integer represent an unsigned integer in base 128, most significant digit first, with as few digits as possible. Bit eight (the high bit) is set on each byte except the last (*Self-Describing Binary Data Representation*, MacLeod)

## Template characters for `String#unpack`

Format	Function	Returns
A	String with trailing NULs and spaces removed.	String
a	String.	String
B	Extract bits from each character (MSB first).	String
b	Extract bits from each character (LSB first).	String
C	Extract a character as an unsigned integer.	Fixnum
c	Extract a character as an integer.	Fixnum
d,D	Treat <i>sizeof(double)</i> characters as a native double.	Float
E	Treat <i>sizeof(double)</i> characters as a double in little-endian byte order.	Float
e	Treat <i>sizeof(float)</i> characters as a float in little-endian byte order.	Float
f,F	Treat <i>sizeof(float)</i> characters as a native float.	Float
G	Treat <i>sizeof(double)</i> characters as a double in network byte order.	Float
g	Treat <i>sizeof(float)</i> characters as a float in network byte order.	Float
H	Extract hex nibbles from each character (most significant first).	String
h	Extract hex nibbles from each character (least significant first).	String
I	Treat <i>sizeof(int)</i> <sup>1</sup> successive characters as an unsigned native integer.	Integer
i	Treat <i>sizeof(int)</i> <sup>1</sup> successive characters as a signed native integer.	Integer
L	Treat four <sup>1</sup> successive characters as an unsigned native long integer.	Integer
l	Treat four <sup>1</sup> successive characters as a signed native long integer.	Integer
M	Extract a quoted-printable string.	String
m	Extract a Base64 encoded string.	String
N	Treat four characters as an unsigned long in network byte order.	Fixnum
n	Treat two characters as an unsigned short in network byte order.	Fixnum
P	Treat <i>sizeof(char *)</i> characters as a pointer, and return <i>len</i> characters from the referenced location.	String
p	Treat <i>sizeof(char *)</i> characters as a pointer to a null-terminated string.	String
Q	Treat eight characters as an unsigned quad word (64 bits).	Integer
q	Treat eight characters as a signed quad word (64 bits).	Integer
S	Treat two <sup>1</sup> successive characters as an unsigned short in native byte order.	Fixnum
s	Treat two <sup>1</sup> successive characters as a signed short in native byte order.	Fixnum
U	Extract UTF-8 characters as unsigned integers.	Integer
u	Extract a UU-encoded string.	String
V	Treat four characters as an unsigned long in little-endian byte order.	Fixnum
v	Treat two characters as an unsigned short in little-endian byte order.	Fixnum
w	BER-compressed integer (see <code>Array#pack</code> for more information).	Integer
X	Skip backward one character.	—
x	Skip forward one character.	—
Z	String with trailing NULs removed.	String
@	Skip to the offset given by the length argument.	—

<sup>1</sup> May be modified by appending “\_” to the directive.

**Character class abbreviations**

<b>Sequence</b>	<b>As [ ... ]</b>	<b>Meaning</b>
<code>\d</code>	<code>[0-9]</code>	Digit character
<code>\D</code>	<code>[^0-9]</code>	Any character except a digit
<code>\s</code>	<code>[\s\t\r\n\f]</code>	Whitespace character
<code>\S</code>	<code>[^\s\t\r\n\f]</code>	Any character except whitespace
<code>\w</code>	<code>[A-Za-z0-9_]</code>	Word character
<code>\W</code>	<code>[^A-Za-z0-9_]</code>	Any character except a word character

**POSIX Character Classes**

<code>[:alnum:]</code>	Alphanumeric
<code>[:alpha:]</code>	Uppercase or lowercase letter
<code>[:blank:]</code>	Blank and tab
<code>[:cntrl:]</code>	Control characters (at least 0x00–0x1f, 0x7f)
<code>[:digit:]</code>	Digit
<code>[:graph:]</code>	Printable character excluding space
<code>[:lower:]</code>	Lowercase letter
<code>[:print:]</code>	Any printable character (including space)
<code>[:punct:]</code>	Printable character excluding space and alphanumeric
<code>[:space:]</code>	Whitespace (same as <code>\s</code> )
<code>[:upper:]</code>	Uppercase letter
<code>[:xdigit:]</code>	Hex digit (0–9, a–f, A–F)

**printf flag characters**

Flag	Applies to	Meaning
␣ (space) <i>digit</i> \$	bdEefGgiouXx all	Leave a space at the start of positive numbers. Specify the absolute argument number for this field. Absolute and relative argument numbers cannot both be used in a <code>printf</code> string.
#	beEfgGoxX	Use an alternative format. For the conversions b, o, X, and x, prefix the result with b, 0, 0X, 0x, respectively. For E, e, f, G, and g, force a decimal point to be added, even if no digits follow. For G and g, do not remove trailing zeros.
+	bdEefGgiouXx	Add a leading plus sign to positive numbers.
-	all	Left-justify the result of this conversion.
0 (zero)	bdEefGgiouXx	Pad with zeros, not spaces.
*	all	Use the next argument as the field width. If negative, left-justify the result. If the asterisk is followed by a number and a dollar sign, use the indicated argument as the width.

**sprintf field types**

Field	Conversion
b	Convert argument as a binary number.
c	Argument is the numeric code for a single character.
d	Convert argument as a decimal number.
E	Equivalent to e, but uses an uppercase <i>E</i> to indicate the exponent.
e	Convert floating point-argument into exponential notation with one digit before the decimal point. The precision determines the number of fractional digits (defaulting to six).
f	Convert floating-point argument as <code>[<u>l</u>]-]ddd.ddd</code> , where the precision determines the number of digits after the decimal point.
G	Equivalent to g, but use an uppercase <i>E</i> in exponent form.
g	Convert a floating-point number using exponential form if the exponent is less than $-4$ or greater than or equal to the precision, or in <code>d.ddd</code> form otherwise.
i	Identical to d.
o	Convert argument as an octal number.
<u>1.8</u> p	The value of <i>argument.inspect</i> .
s	Argument is a string to be substituted. If the format sequence contains a precision, at most that many characters will be copied.
u	Treat argument as an unsigned decimal number.
X	Convert argument as a hexadecimal number using uppercase letters. Negative numbers will be displayed with two leading periods (representing an infinite string of leading FFs).
x	Convert argument as a hexadecimal number. Negative numbers will be displayed with two leading periods (representing an infinite string of leading FFs.)

**Time#strftime directives**

---

<b>Format</b>	<b>Meaning</b>
%a	The abbreviated weekday name (“Sun”)
%A	The full weekday name (“Sunday”)
%b	The abbreviated month name (“Jan”)
%B	The full month name (“January”)
%c	The preferred local date and time representation
%d	Day of the month (01..31)
%H	Hour of the day, 24-hour clock (00..23)
%I	Hour of the day, 12-hour clock (01..12)
%j	Day of the year (001..366)
%m	Month of the year (01..12)
%M	Minute of the hour (00..59)
%p	Meridian indicator (“AM” or “PM”)
%S	Second of the minute (00..60)
%U	Week number of the current year, starting with the first Sunday as the first day of the first week (00..53)
%W	Week number of the current year, starting with the first Monday as the first day of the first week (00..53)
%w	Day of the week (Sunday is 0, 0..6)
%x	Preferred representation for the date alone, no time
%X	Preferred representation for the time alone, no date
%y	Year without a century (00..99)
%Y	Year with century
%Z	Time zone name
%%	Literal % character

---

## File tests with a single argument

Flag	Description	Returns
?A	Last access time for <i>file1</i>	Time
?b	True if <i>file1</i> is a block device	true or false
?c	True if <i>file1</i> is a character device	true or false
?C	Last change time for <i>file1</i>	Time
?d	True if <i>file1</i> exists and is a directory	true or false
?e	True if <i>file1</i> exists	true or false
?f	True if <i>file1</i> exists and is a regular file	true or false
?g	True if <i>file1</i> has the setgid bit set (false under NT)	true or false
?G	True if <i>file1</i> exists and has a group ownership equal to the caller's group	true or false
?k	True if <i>file1</i> exists and has the sticky bit set	true or false
?l	True if <i>file1</i> exists and is a symbolic link	true or false
?M	Last modification time for <i>file1</i>	Time
?o	True if <i>file1</i> exists and is owned by the caller's effective UID	true or false
?O	True if <i>file1</i> exists and is owned by the caller's real UID	true or false
?p	True if <i>file1</i> exists and is a fifo	true or false
?r	True if <i>file1</i> is readable by the effective UID/GID of the caller	true or false
?R	True if <i>file1</i> is readable by the real UID/GID of the caller	true or false
?s	If <i>file1</i> has nonzero size, return the size, otherwise return nil	Integer or nil
?S	True if <i>file1</i> exists and is a socket	true or false
?u	True if <i>file1</i> has the setuid bit set	true or false
?w	True if <i>file1</i> exists and is writable by the effective UID/ GID	true or false
?W	True if <i>file1</i> exists and is writable by the real UID/GID	true or false
?x	True if <i>file1</i> exists and is executable by the effective UID/GID	true or false
?X	True if <i>file1</i> exists and is executable by the real UID/GID	true or false
?z	True if <i>file1</i> exists and has a zero length	true or false

## File tests with two arguments

Flag	Description
?-	True if <i>file1</i> is a hard link to <i>file2</i>
?=	True if the modification times of <i>file1</i> and <i>file2</i> are equal
?<	True if the modification time of <i>file1</i> is prior to that of <i>file2</i>
?>	True if the modification time of <i>file1</i> is after that of <i>file2</i>

# Pragmatic Starter Kit

**Version Control. Unit Testing. Project Automation.** Three great titles, one objective. To get you up to speed with the essentials for successful project development. Keep your source under control, your bugs in check, and your process repeatable with these three concise, readable books from The Pragmatic Bookshelf.

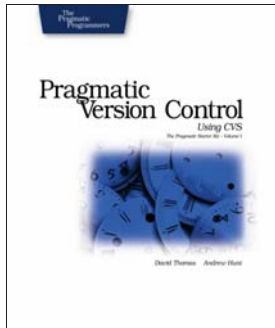

- Keep your project assets safe—never lose a great idea
- Know how to UNDO bad decisions—no matter when they were made
- Learn how to share code safely, and work in parallel
- See how to avoid costly code freezes
- Manage 3<sup>rd</sup> party code
- Understand how to go back in time, and work on previous versions.

## **Pragmatic Version Control**

Dave Thomas and Andy Hunt

(176 pages) ISBN: 0-9745140-0-4. \$29.95

- Write better code, faster
- Discover the hiding places where bugs breed
- Learn how to think of all the things that could go wrong
- Test pieces of code without using the whole project
- Use JUnit to simplify your test code
- Test effectively with the whole team.

## **Pragmatic Unit Testing**

Andy Hunt and Dave Thomas

(176 pages) ISBN: 0-9745140-1-2. \$29.95

(Also available for C#, ISBN: 0-9745140-2-0)

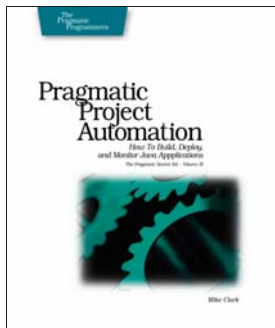
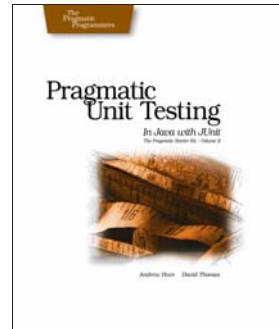

- Common, freely available tools which automate build, test, and release procedures
- Effective ways to keep on top of problems
- Automate to create better code, and save time and money
- Create and deploy releases easily and automatically
- Have programs to monitor themselves and report problems.

## **Pragmatic Project Automation**

Mike Clark

(176 pages) ISBN: 0-9745140-3-9. \$29.95

Visit our secure online store: <http://pragmaticprogrammer.com/catalog>



# The Pragmatic Bookshelf

---

A new line in books written by developers, published by developers, aimed squarely at the needs of developers. Information rich books, designed to be practical and applicable. Available in printed form and PDF. Check us out on the web at [pragmaticbookshelf.com](http://pragmaticbookshelf.com), and have a look on the previous page for information on our *Pragmatic Starter Kit*.

## Visit Us Online

---

### **Programming Ruby Home Page**

[pragmaticprogrammer.com/titles/ruby](http://pragmaticprogrammer.com/titles/ruby)

Source code from this book, errata, and other resources. Come give us feedback, too!

### **Register for Updates**

[pragmaticprogrammer.com/updates](http://pragmaticprogrammer.com/updates)

Be notified when updates and new books become available.

### **Join the Community**

[pragmaticprogrammer.com/community](http://pragmaticprogrammer.com/community)

Read our weblogs, join our online discussions, participate in our mailing list, interact with our wiki, and benefit from the experience of other Pragmatic Programmers.

### **New and Noteworthy**

[pragmaticprogrammer.com/news](http://pragmaticprogrammer.com/news)

Check out the latest pragmatic developments in the news.

## Save on the PDF

---

Save 60% on the PDF version of this book. Owning the paper version of this book entitles you to purchase the PDF version for only \$10.00 (regularly \$25.00). The PDF is great for carrying around on your laptop. It's hyperlinked, has color, and is fully searchable. Buy it now at [pragmaticprogrammer.com/coupon](http://pragmaticprogrammer.com/coupon)

## Contact Us

---

Phone Orders:	1-800-699-PROG (+1 919 847 3884)
Online Orders:	<a href="http://www.pragmaticprogrammer.com/catalog">www.pragmaticprogrammer.com/catalog</a>
Customer Service:	<a href="mailto:orders@pragmaticprogrammer.com">orders@pragmaticprogrammer.com</a>
Non-English Versions:	<a href="mailto:translations@pragmaticprogrammer.com">translations@pragmaticprogrammer.com</a>
Pragmatic Teaching:	<a href="mailto:academic@pragmaticprogrammer.com">academic@pragmaticprogrammer.com</a>
Author Proposals:	<a href="mailto:proposals@pragmaticprogrammer.com">proposals@pragmaticprogrammer.com</a>